

NV ENERGY LINE 1104

SPECIAL USE PERMIT

PREPARED FOR:



PREPARED BY:



AUGUST 8, 2023

UPDATED APPLICATION - 3/8/2024

PROJECT: 23092.00

Table of Contents

Washoe County Development and SUP Application Forms Berfore Tabs

Project Narrative Tab A

 Project Introduction 1

 Project Location/Route Alignment 2

 Project of Regional Significance & Regional Utility Corridors (RUC's)..... 4

 Project Requests..... 5

Special Use Permit 5

Height Variation 6

Parking Waiver..... 6

Landscaping Waiver..... 6

Master Plan and Zoning 7

Photo Simulations – Various Site Locations (Verdi Area)..... 9

Special Use Permit Findings 11

Project Map & Pole Structure Elevations B

Project COM Plan and Final ROD..... D

Supporting Information E

 Proof of Property Tax Payment

 Neighborhood Meeting Summary

 Mobile Home Mailing Label Spreadsheet

Washoe County Development Application

Your entire application is a public record. If you have a concern about releasing personal information, please contact Planning and Building staff at 775.328.6100.

Project Information		Staff Assigned Case No.: _____	
Project Name:			
Project Description:			
Project Address:			
Project Area (acres or square feet):			
Project Location (with point of reference to major cross streets AND area locator):			
Assessor's Parcel No.(s):	Parcel Acreage:	Assessor's Parcel No.(s):	Parcel Acreage:
Indicate any previous Washoe County approvals associated with this application: Case No.(s).			
Applicant Information (attach additional sheets if necessary)			
Property Owner:		Professional Consultant:	
Name:		Name:	
Address:		Address:	
Zip:		Zip:	
Phone: Fax:		Phone: Fax:	
Email:		Email:	
Cell: Other:		Cell: Other:	
Contact Person:		Contact Person:	
Applicant/Developer:		Other Persons to be Contacted:	
Name:		Name:	
Address:		Address:	
Zip:		Zip:	
Phone: Fax:		Phone: Fax:	
Email:		Email:	
Cell: Other:		Cell: Other:	
Contact Person:		Contact Person:	
For Office Use Only			
Date Received: Initial:		Planning Area:	
County Commission District:		Master Plan Designation(s):	
CAB(s):		Regulatory Zoning(s):	

PARCELS FOR NV ENERGY 1104 LINE

TRANSMISSION LINE PARCEL OWNERSHIP

APN	Owner	Jurisdiction	Sofl
038-822-01	MYERS 2017 TRUST, RAYMOND A	Washoe County	Washoe County
038-821-20	VERDI LAKE LLC	City of Reno	City of Reno
038-042-20	NV Energy	Washoe County	Washoe County
038-043-05	NV Energy	Washoe County	Washoe County
038-044-06	NV Energy	Washoe County	Washoe County
038-045-46	NV Energy	Washoe County	Washoe County
038-060-37	NV Energy	Washoe County	RSOI
038-280-43	NV Energy	Washoe County	RSOI
238-320-04	WEST MEADOWS HOMEOWNERS ASSOCIATION	City of Reno	City of Reno
038-010-07	EMERY, ALLYN	Washoe County	Washoe County
038-010-05	LUCAS, STAN	City of Reno	City of Reno
081-170-10	CHURCHILL TRUST et al, DAVID E	Washoe County	Washoe County
081-070-06	USFS	Washoe County	Washoe County
081-070-29	USFS	Washoe County	Washoe County
081-050-46	USFS	Washoe County	Washoe County
081-010-01	USFS	Washoe County	Washoe County
081-010-05	USFS	Washoe County	Washoe County
081-010-06	LIFESTYLE HOMES TND LLC	Washoe County	RSOI
558-010-06	JCJJ&J TRUST	City of Reno	City of Reno
081-010-18	HEINZ RANCH LAND COMPANY LLC	City of Reno	City of Reno
081-110-06	LIFESTYLE HOMES TND LLC	City of Reno	City of Reno
081-110-05	LIFESTYLE HOMES TND LLC	City of Reno	City of Reno
081-110-04	LIFESTYLE HOMES TND LLC	City of Reno	City of Reno
ACCESS EASEMENTS			
038-550-44	KRONISH TRUST, HERBERT	Washoe County	Washoe County
081-070-20	INSKIP et al, RICHARD R	Washoe County	Washoe County
081-050-11	KING, CLINTON W	Washoe County	Washoe County



May 2, 2023

To: All Interested Parties

RE: Signature Authority of Matt Gingerich

The undersigned is Senior Vice President, General Counsel, Corporate Secretary and Chief Compliance Officer of Nevada Power Company, a Nevada corporation d/b/a NV Energy and Sierra Pacific Power Company, a Nevada corporation d/b/a NV Energy (collectively, "NV Energy").

As of the date of this letter, Matt Gingerich is Director of Land Resources of NV Energy. As Director of Land Resources, Mr. Gingerich is authorized to sign on behalf of NV Energy the following documents:

1. Land use permits and parcel mapping required by local municipalities;
2. Grants of easements, access to equipment agreements, transmission use agreements, distribution encroachment agreements and deeds;
3. Relinquishments of easements granted on private property or rights contained in government patent easements and on final subdivision maps containing relinquishment language; and
4. Agreements relating to the acquisition of easements; and
5. Letters of intent, non-disclosure agreements and purchase agreements; and
6. Land ownership affidavit; and
7. Parcel maps; and
8. License Agreements; and
9. Other agreements related to obtaining land rights.

This letter will expire one (1) year from the date of issuance.

NV ENERGY

A handwritten signature in black ink, appearing to read "Brandon Barkhuff".

Brandon Barkhuff
Senior Vice President, General Counsel,
Corporate Secretary and Chief Compliance Officer

Special Use Permit Application Supplemental Information

(All required information may be separately attached)

1. What is the project being requested?

2. Provide a site plan with all existing and proposed structures (e.g. new structures, roadway improvements, utilities, sanitation, water supply, drainage, parking, signs, etc.)

3. What is the intended phasing schedule for the construction and completion of the project?

4. What physical characteristics of your location and/or premises are especially suited to deal with the impacts and the intensity of your proposed use?

5. What are the anticipated beneficial aspects or affects your project will have on adjacent properties and the community?

6. What are the anticipated negative impacts or affect your project will have on adjacent properties? How will you mitigate these impacts?

7. Provide specific information on landscaping, parking, type of signs and lighting, and all other code requirements pertinent to the type of use being purposed. Show and indicate these requirements on submitted drawings with the application.

8. Are there any restrictive covenants, recorded conditions, or deed restrictions (CC&Rs) that apply to the area subject to the special use permit request? (If so, please attach a copy.)

<input type="checkbox"/> Yes	<input type="checkbox"/> No
------------------------------	-----------------------------

9. Utilities:

a. Sewer Service	
b. Electrical Service	
c. Telephone Service	
d. LPG or Natural Gas Service	
e. Solid Waste Disposal Service	
f. Cable Television Service	
g. Water Service	

For most uses, Washoe County Code, Chapter 110, Article 422, Water and Sewer Resource Requirements, requires the dedication of water rights to Washoe County. Please indicate the type and quantity of water rights you have available should dedication be required.

h. Permit #		acre-feet per year	
i. Certificate #		acre-feet per year	
j. Surface Claim #		acre-feet per year	
k. Other #		acre-feet per year	

Title of those rights (as filed with the State Engineer in the Division of Water Resources of the Department of Conservation and Natural Resources).

--

10. Community Services (provided and nearest facility):

a. Fire Station	
b. Health Care Facility	
c. Elementary School	
d. Middle School	
e. High School	
f. Parks	
g. Library	
h. Citifare Bus Stop	

**Special Use Permit Application
for Grading
Supplemental Information**
(All required information may be separately attached)

1. What is the purpose of the grading?

2. How many cubic yards of material are you proposing to excavate on site?

3. How many square feet of surface of the property are you disturbing?

The following areas include all existing graded road widths and are a very conservative estimate - 65.7 acres total, 37.3 acres of temporary road widening, 28.4 acres of new temporary access roads (see Section 3.1.3 of Project Construction, Operation, and Maintenance (COM) Plan).

4. How many cubic yards of material are you exporting or importing? If none, how are you managing to balance the work on-site?

5. Is it possible to develop your property without surpassing the grading thresholds requiring a Special Use Permit? (Explain fully your answer.)

6. Has any portion of the grading shown on the plan been done previously? (If yes, explain the circumstances, the year the work was done, and who completed the work.)

7. Have you shown all areas on your site plan that are proposed to be disturbed by grading? (If no, explain your answer.)

8. Can the disturbed area be seen from off-site? If yes, from which directions and which properties or roadways?

9. Could neighboring properties also be served by the proposed access/grading requested (i.e. if you are creating a driveway, would it be used for access to additional neighboring properties)?

10. What is the slope (horizontal/vertical) of the cut and fill areas proposed to be? What methods will be used to prevent erosion until the revegetation is established?

11. Are you planning any berms?

Yes	No	If yes, how tall is the berm at its highest?
-----	----	--

12. If your property slopes and you are leveling a pad for a building, are retaining walls going to be required? If so, how high will the walls be and what is their construction (i.e. rockery, concrete, timber, manufactured block)?

13. What are you proposing for visual mitigation of the work?

14. Will the grading proposed require removal of any trees? If so, what species, how many and of what size?

15. What type of revegetation seed mix are you planning to use and how many pounds per acre do you intend to broadcast? Will you use mulch and, if so, what type?

We will use the seed mix approved by USFS and the Washoe Storey Conservation District Best Management Practices. The actual seed mixture is in Appendix C3 of the Project COM Plan, Table 5-1.

16. How are you providing temporary irrigation to the disturbed area?

--

17. Have you reviewed the revegetation plan with the Washoe Storey Conservation District? If yes, have you incorporated their suggestions?

--

18. Are there any restrictive covenants, recorded conditions, or deed restrictions (CC&Rs) that may prohibit the requested grading?

Yes	No	If yes, please attach a copy.
-----	----	-------------------------------

16. What types of landscaping (e.g. shrubs, trees, fencing, painting scheme, etc.) are proposed? (Please indicate location on site plan.)

--

17. What type of signs and lighting will be provided? On a separate sheet, show a depiction (height, width, construction materials, colors, illumination methods, lighting intensity, base landscaping, etc.) of each sign and the typical lighting standards. (Please indicate location of signs and lights on site plan.)

--

18. Are there any restrictive covenants, recorded conditions, or deed restrictions (CC&Rs) that apply to the area subject to the administrative permit request? (If so, please attach a copy.)

<input type="checkbox"/> Yes	<input type="checkbox"/> No
------------------------------	-----------------------------

19. Community Sewer

<input type="checkbox"/> Yes	<input type="checkbox"/> No
------------------------------	-----------------------------

20. Community Water

<input type="checkbox"/> Yes	<input type="checkbox"/> No
------------------------------	-----------------------------

TAB A



Project Introduction

The project presented in this application crosses both unincorporated Washoe County and City of Reno lands. As such, separate applications have been prepared for review by the two jurisdictions. The United States Forest Service has reviewed, approved, and conditioned the project, appropriately relative to the construction, operations and maintenance of the transmission power line. Copies of the Final Environmental Impact Statement (FEIS) and final Record of Decision (ROD) have been provided with this application submittal. A Construction, Operation and Maintenance (COM) Plan is provided with this application in Tab C that covers the specifics of the line development, operations and maintenance. This introduction/Project Narrative covers the Washoe County special use permit specific information and relies on the previously prepared COM Plan for review details.

This application requests the approval of a special use permit from Washoe County for the proposed use – Utility Services. Any grading in association with the project is primarily temporary grading activities associated with construction of the line. Per the FEIS,

“any ground disturbance outside of the Right Of Way (ROW) would consist of construction of access roads, widening existing roads, use of staging areas, and construction within transmission wire setup sites. The USFS would issue a temporary SUP for temporary roads and construction activity located outside of the transmission line ROW. Restoration would be required at the completion of construction to recontour and revegetate areas disturbed areas in the project area.” (EIS, page ES-i)

This application requests the approval of a special use permit from Washoe County for the proposed use and major grading associated with temporary grading activities associated with the construction access roads and other elements noted within the FEIS. It should be recognized that grading activities have been reviewed, approved and stipulations for restoration have been provided by the USGS through the FEIS process.

Additionally requested are deviation or variation from certain design aspects of the Washoe County Development Code (WCDC) including heights, parking, and landscaping.

Project Location/Route Alignment

NV Energy Line 1104 is a 120 kV transmission power line that is proposed to run between the Bordertown Substation (near Cold Springs) and the California Substation (near Verdi). A schematic vicinity map is provided, to the left and a more detailed route/vicinity map is provided on the following page, both showing the alignment of this transmission power line.

The transmission line is approximately 12.0 miles long with 10.9+/- miles in Nevada. Approximately 6.8 miles of the run in Nevada lies within unincorporated Washoe County while the remaining 4.1+/- miles lies within the jurisdiction of the City of Reno. From the Bordertown Substation, it heads southwest, paralleling the west side of the Alturas 345-kV transmission line (Figure 2). It then generally parallels the California and Nevada state line, staying on the Nevada side by approximately 0.6 to 0.9 miles east of the state line for approximately 6 miles. The line then jogs another approximately 0.7 miles to the east, approximately 1.5 miles from the state line which it parallels for another 3 miles before turning due west. The last 2+/- miles will parallel to the existing #114 and #106 lines through Verdi to the California Substation.

The proposed transmission power line will cross the following parcels that lie within unincorporated Washoe County:

038-822-01, 038-042-20, 038-043-05, 038-044-06, 038-045-46, 038-060-37, 038-280-43, 038-010-07, 081-170-10, 081-070-06, 081-070-29, 081-050-46, 081-010-01, 081-010-05, 081-010-06, 558-010-06

Additional parcels are located within the City of Reno and Sierra County of California jurisdictions.

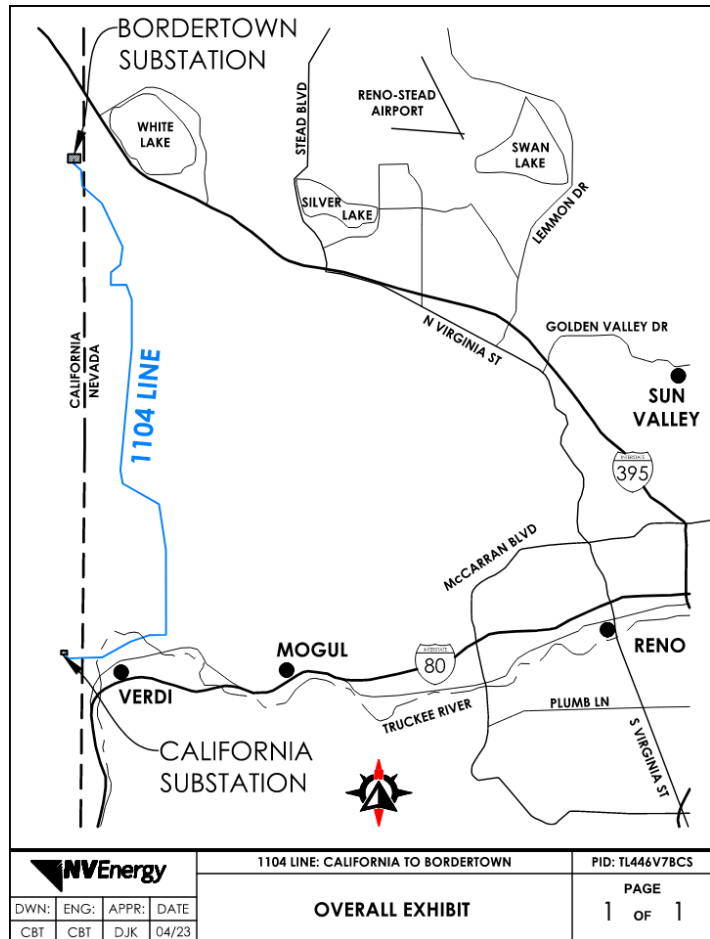

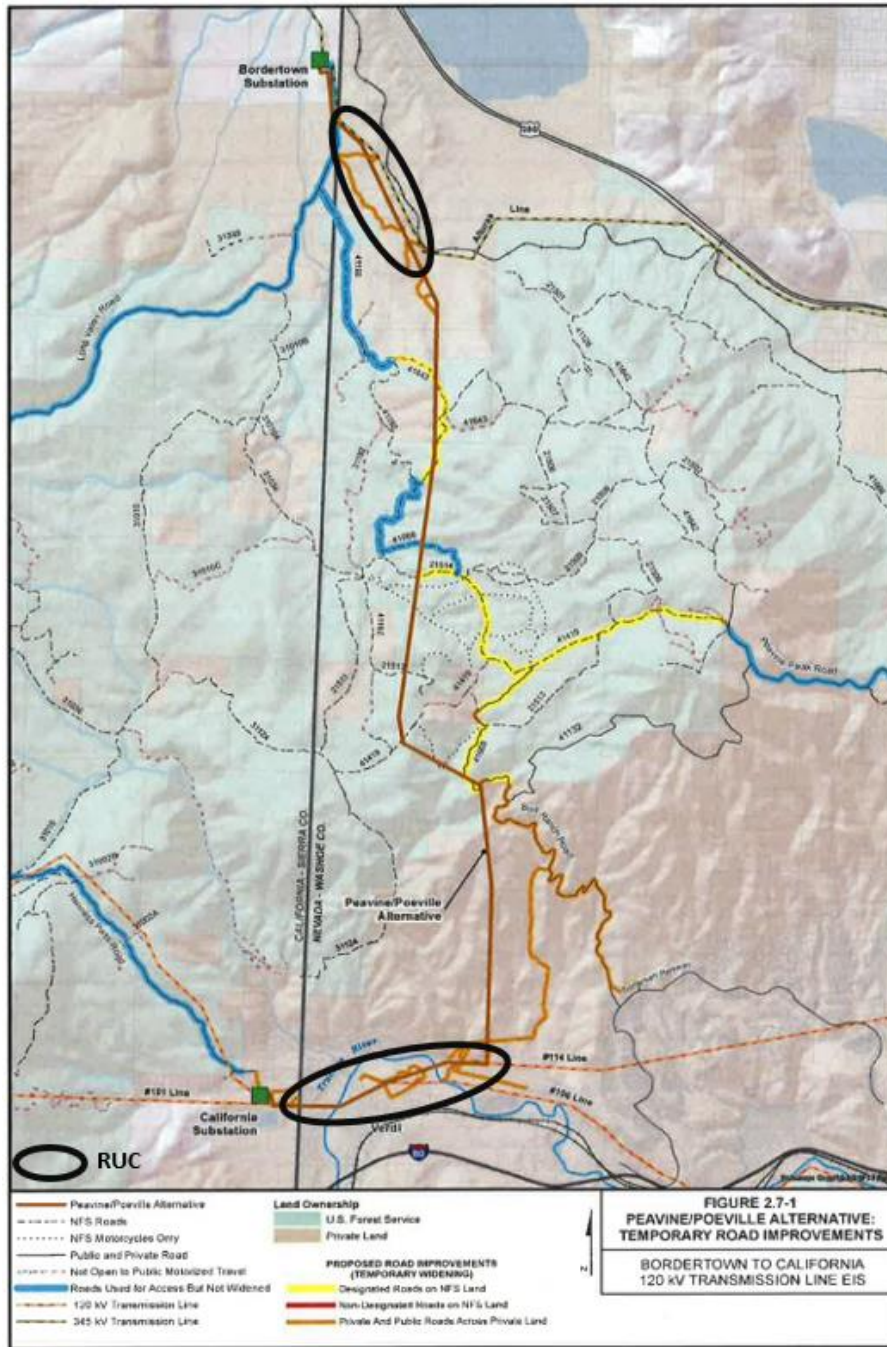

Map from EIS document with line route that had not been modified, slightly through agreement with private property owner of 081-010-18 within the City of Reno jurisdiction.

The proposed alignment of the power line, the temporary access roads and staging areas needed for construction of the line cross multiple properties with some in unincorporated Washoe County and some within the City of Reno.

Project of Regional Significance & Regional Utility Corridors (RUC's)

The proposed project, being a transmission power line necessitates a project of regional significance review through the Truckee Meadows Regional Planning Agency. Additionally, a new Regional Utility Corridor will need to be established to cover the portion of the line that is not proposed to jointly run within existing corridors. Below is a copy of the Truckee Meadows Regional Plan – Regional Utility Corridors & Sites exhibit. The approximate alignment of the proposed Line 1104 has been shown on this exhibit.

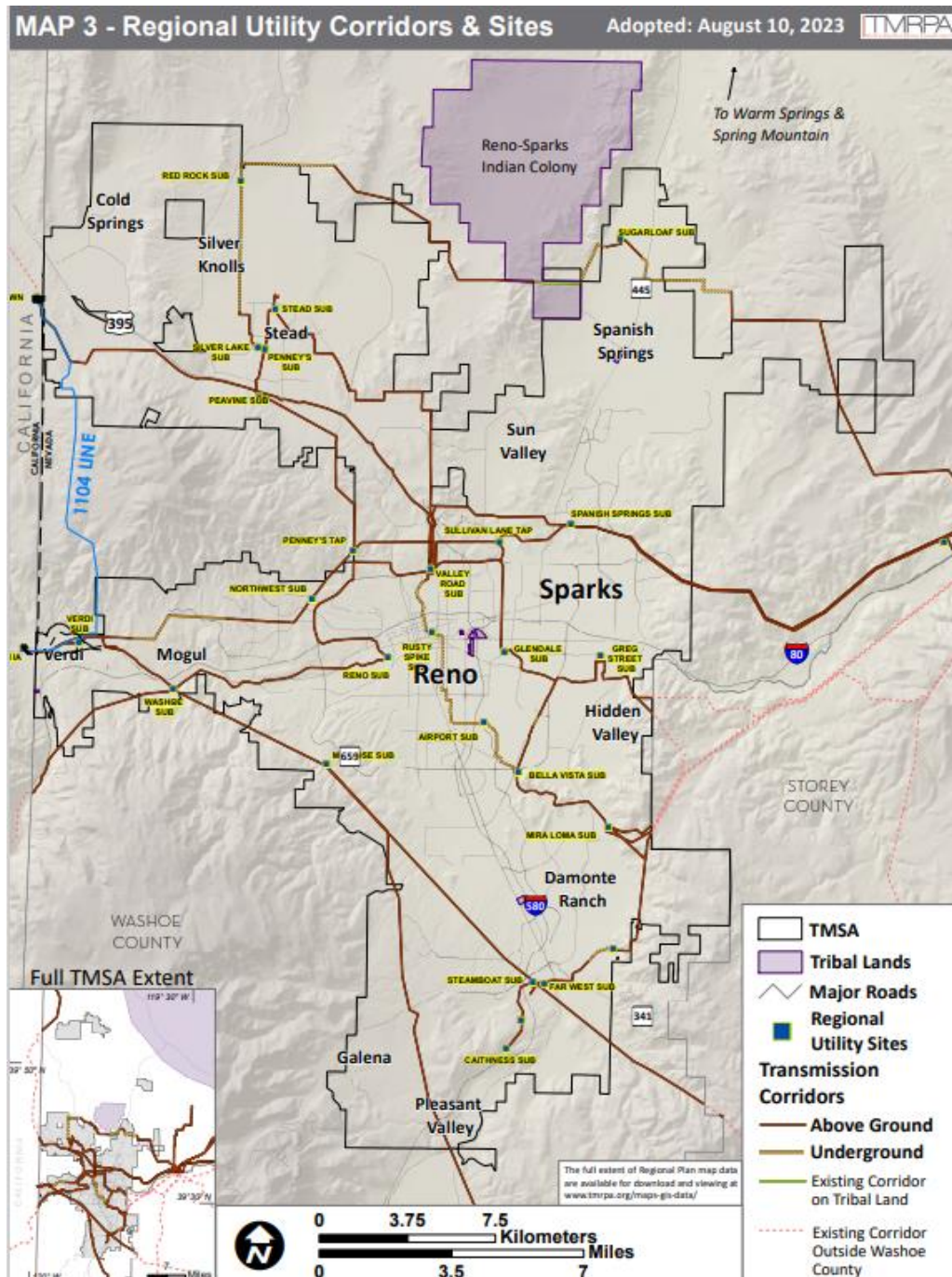

Project Requests

This application specifically requests the following requests, inclusive of special use permit considerations as well as variation or deviation from certain standards within the WCDC.

Special Use Permit

Special Use Permit for Use – a special use permit is requested for the use of a Utility Services within the GR (General Rural) and OS (Open Space) zoning designations.

Special Use Permit for Major Grading - a special use permit is requested for major grading relative to the standards set forth in Article 438 of the Washoe County Development Code (WCDC).

The request for the special use permit for major grading is formally made, but the applicant believes that the proposed use, being a public utility, should be exempt from such a special use permit requirement, per 110.438.35(a)(2)(b)(2), which states that a special use permit is not required for public utilities within the public right-of-way or a public utility easement. The project through unincorporated Washoe County runs predominately through federally controlled lands with the appropriate federal permits/rights-of-way and/or regional utility corridors. The grading in association with the temporary access roads has already been reviewed and stipulated to be restored after construction use by the USFS through the approval of the FEIS and provision of the final ROD.

If an SUP for major grading is deemed to be required, the specific sections of Article 438 that we believe to be applicable to this request include:

110.438.35 (a)(1) Grading on slopes less than or flatter than 15%

Area - (i)(C) Grading of an area of more than four (4) acres on a parcel of any size

Volume (ii)(A) Excavation of five thousand (5,000) cubic yards or more whether the material is intended to be permanently located on the project site or temporarily stored on a site for relocation to another, final site.

110.438.35 (a)(2) Grading on slopes of 15% or greater (steeper)

Area – (I)(C) Grading of more than two (2) acres on any size parcel

Volume (ii)(A) Excavation of five thousand (1,000) cubic yards or more whether the material is intended to be permanently located on the project site or temporarily stored on a site for relocation to another, final site.

110.438.35(a)(3) – Any driveway or road that traverses any slope of thirty (30) percent or greater (steeper) – Due to the terrain where the proposed line will cross, there will be temporary access roads or existing access road widening that will need to cross or traverse areas that are 30% or steeper in slope.

Variation from the grading standards of the following is also requested:

Additional Requests – deviation or waiver requests from various code standards

Height Allowances per Table 110.406.05.1 – the proposed pole heights (ranging between 50’ and 105’ – above ground) will exceed the listed height allowances under the PSP and GR zoning designations.

Article 410 – Parking – Due to the nature of the project, no parking is necessary and a full waiver from any requirements for parking is requested.

Article 412 – Landscaping – Due to the nature of the project, it is requested that a full waiver from typical landscape requirements be provided for the project. There are revegetation requirements that the USFS has already put on the project that will be followed and these can be seen in the Construction, Operation and Maintenance (COM) Plan provided with this introduction narrative.

Height Variation

The proposed poles to be used for the transmission line will range between 50 feet to 105 feet in height depending upon the location, angle of the line at the pole, topography, or necessary crossings of other elements. The GR zoning allows for a height of 35 feet, and it will be necessary to have the allowance to appropriately exceed this height with the poles to meet nationally regulated requirements for clearance and safety. The OS zone does not have a maximum height listed. As such, no deviation from the stipulated heights for that zoning designation would be necessary. Details of the proposed structures are provided in Tab B with this application.

Parking Waiver

Table 110.410.10.2 identifies that Utility Services require no parking per the square footage of the project and parking per employee during peak employment shift is identified to be “as specified by use permit.” There will be no employees nor peak shifts associated with this project. As such, we request a full waiver from any parking requirements identified under Article 410 of the WCDC.

Landscaping Waiver

As part of the special use permit, it is requested that a waiver from landscape standards identified in Article 412 of the WCDC be granted. The provision of any landscaping would not provide intended screening that is paramount in the requirement for landscaping of project. Additionally, any requirement for landscaping would draw attention to the location of the line of pole structures through much of the terrain where the route is located.

The USFS has reviewed the project and has requirements and stipulations associated with remediation and revegetation of temporary grading and widening for the necessary access roads. The decided route was chosen with regard to minimizing impacts to existing vegetation, and “maximizes crossing land previously disturbed by wildland fire and minimizes crossing...sensitive areas.” (source: Page ES-ii, Bordertown to California 120kV Transmission Line Final EIS)

Master Plan and Zoning

The parcels crossed by the proposed line route running through unincorporated Washoe County are master planned Open Space and are zoned General Rural (GR) and Open Space (OS). Most of the land area that lies within unincorporate Washoe County’s jurisdiction are federally owned properties administered by the USFS. Below are exhibits of the Master Plan and Zoning maps for Washoe County within the vicinity of the project route. The project route has been approximately shown on these exhibits. An enlarged exhibit of each has been provided for the Verdi area as the designations in this area are difficult to see in the larger scale exhibit.

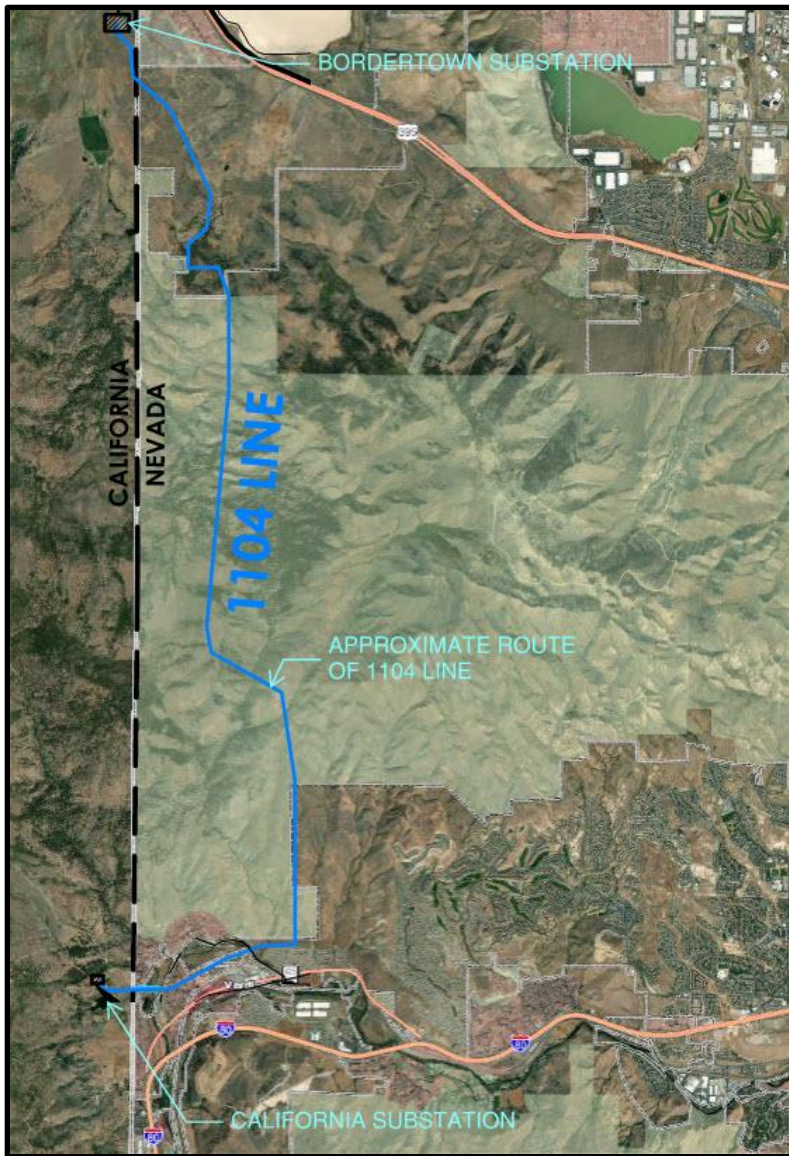

Utility Services are allowed with the review and approval of a special use permit under the GR and OS zoning designations, per Table 110.302.05.2 in the Washoe County Development Code (WCDC)

Master Plan Designations of project route – Open Space and Suburban Residential

Master Plan Exhibit (Full Route)

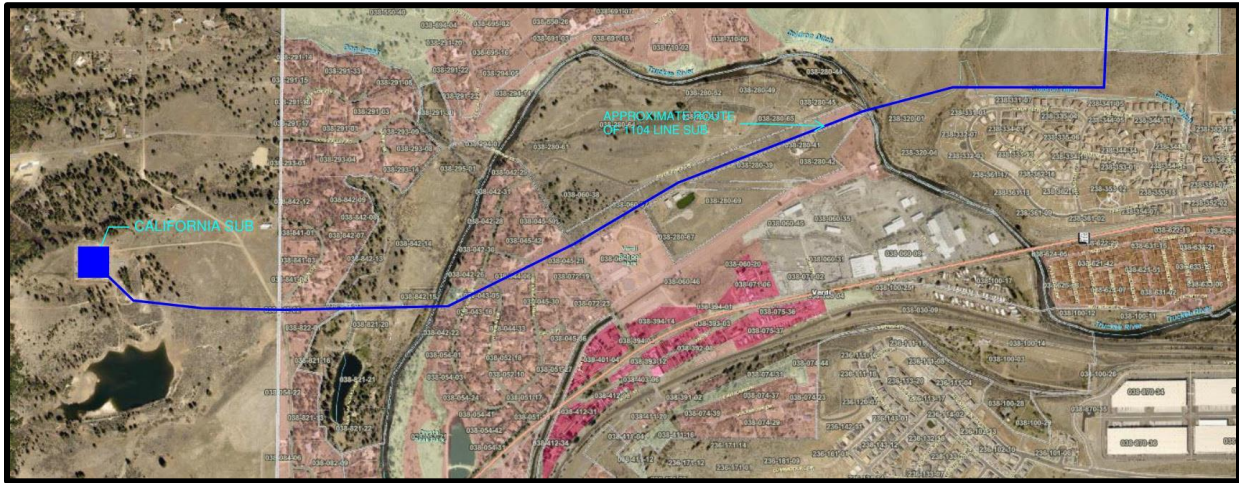

Master Plan Exhibit (Verdi Area)



Zoning Designations of project route – OS, GR, PSP, and LDS

Zoning Exhibit (Full Route)

Photo Simulations – Various Site Locations (Verdi Area)

Following are some photo simulations within the existing Regional Utility Corridor in the Verdi area that show the new pole structures enhanced in the photos. It should be noted that through most of this corridor there are three separate line routes, predominately on H-frame structures. With the proposed 1104 Line, the one new pole route will replace the two northern H-frame structures and the number of overall structures through the segment of line that travels west-east through Verdi will be reduced by 11 total structures from what currently exists. Additional photo simulations of line segments further north are provided within the FEIS that has been submitted with this application (Please refer to Table 3.2-7 Key Observation Points of the FEIS).

Bridge Street Photo Simulations



Looking West



Looking East

Prickly Pear Road Photo Simulations



Looking West



Looking East

Special Use Permit Findings

Article 810 of the Washoe County Development Code identifies findings that must be made in order to approve a special use permit. Following is an identification of each finding and the applicant's response as to how or why this finding is met with this request.

(a) Consistency. The proposed use is consistent with the action programs, policies, standards and maps of the Master Plan and the applicable area plan;

The proposed use of utility services is consistent with the action programs, policies, standards and maps of the Master Plan and applicable area plan(s). The proposed transmission power line is necessary under NERC requirements (Standard TPL-003-0) that NV Energy must follow relative to energy reliability requirements. The proposed route was the preferred option from a USFS EIS process, and a final ROD has been obtained which includes requirements and stipulations for protection of environmental and wildlife areas. The Construction, Operation and Maintenance Plan, provided as part this application in Tab C addresses cultural, environmental, visual, public safety and fire prevention and response and other issues that are covered within the Area Plan policies.

(b) Improvements. Adequate utilities, roadway improvements, sanitation, water supply, drainage, and other necessary facilities have been provided, the proposed improvements are properly related to existing and proposed roadways, and an adequate public facilities determination has been made in accordance with Division Seven;

The purpose of the project is to provide reliable bulk transmission capacity to west Reno consistent with NERC Standard TPL-003-0. Load growth in the Reno area, particularly on the west side, has created bulk electrical transmission problems. Almost all of the power generation in the Reno 120 kV system is on the east side of Reno. The North Valley Road 345/120 kV Substation in north central Reno is currently used to move power through a network of 120 kV lines to the west side. During periods of heavy load, loss of one line in the network could overload the remaining lines, causing a failure that could result in outages in west Reno. (Federal Register, 11/21/2011)

Any access road work for construction will be temporary and is required to be remediated and revegetated at the completion of the construction, per the final ROD. The project will have no impact relative to sanitation, water supply concerns, drainage or other typical development level public infrastructure considerations.

(c) Site Suitability. The site is physically suitable for the type of development and for the intensity of development;

The proposed route has been thoroughly analyzed and approved through the USFS EIS process and a final ROD has been issued. The lengthy federal process considered the site access, existing site conditions, topography, environmental, visual, public safety and fire prevention and response and other considerations. Four alternative routes/actions were considered by the Forest Service, including a No Action alternative. It was determined that a combination of two of the routes was the best – the Peavine/Poeville alternative.

(d) Issuance Not Detrimental. Issuance of the permit will not be significantly detrimental to the public health, safety or welfare; injurious to the property or improvements of adjacent properties; or detrimental to the character of the surrounding area;

Where the project is in proximity to existing residences, the line runs through an existing regional utility corridor. Impacts to structures (existing or future construction) from required electrical setbacks and separation requirements are not anticipated from the chosen route. It is intended that there will be fewer structures within the Verdi regional utility corridor after the construction of this proposed transmission power line through the consolidation and joint circuiting of the new poles.

(e) Effect on a Military Installation. Issuance of the permit will not have a detrimental effect on the location, purpose or mission of the military installation.

There are no military installations located in proximity to the proposed site area. As such, this finding is not applicable.

TAB B



V:\2023\Active\203703160\03_data\gis\mxd\Map_Books\Construction_and_Access_Mapbook\Construction_Map_Book_Cover_Page_Aerial_11x17L.mxd Revised: 2020-05-12 By: christmson

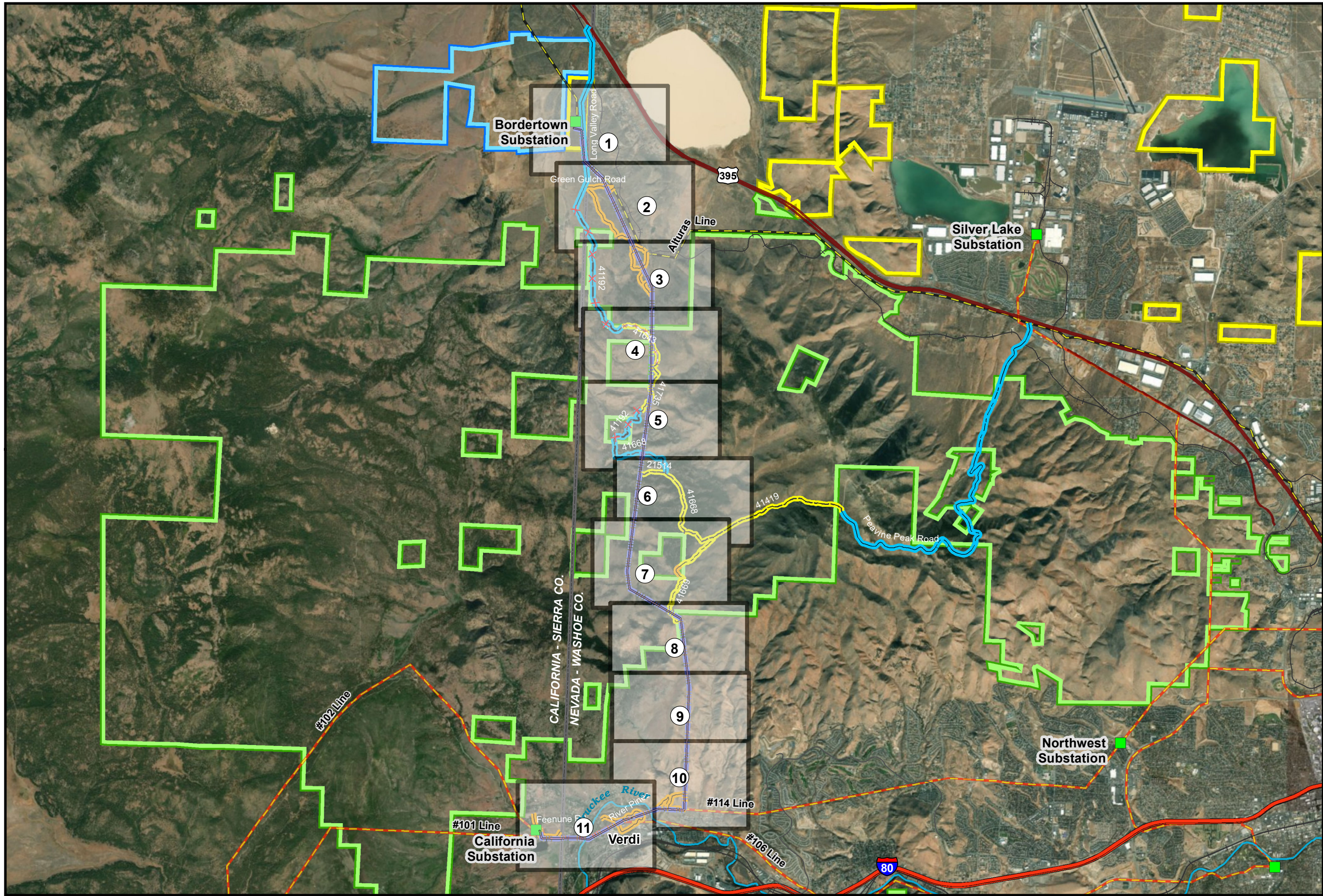

Bordertown to California 120 kV Transmission Line Project Construction and Access Mapbook

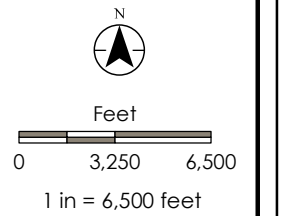

Sierra County, CA &
Washoe County, NV
NAD 1983 UTM Zone 11N







PROJECT NO: 203703160
DRAWN BY: CJ
1ST REVIEW: JT
2ND REVIEW: KC
DATE: 5/12/2020

**MAP BOOK
COVER PAGE**











V:\2037\Active\203703160\03_data\gls_cad\gls\mxd\Map_Books\Construction_and_Access_Mapbook\Construction_Map_Book_Legend.mxd Reviewed: 2020-01-07 By: chjohnson

How to Use This Map Book



This Map Book is intended as the pictorial reference for the construction and access for the Bordertown to California 120 kV Transmission Line Project. Each map sheet is the Centerline Construction and Access Map overlaid on an aerial and topographic photo background depicting Land Ownership, Access, and Construction Vehicle Travel.

-  Peavine\Poeville Alignment
-  90-ft ROW
-  Existing Substation
-  Addition to Substation
-  New Pole Structure
-  New Pole Structure/Existing Pole To Be Removed
-  Wire Set-up Site







Roads

-  USFS Roads
-  USFS Road (Designated Seasonal Use April 1 - November 18)
-  USFS Road Not Open to Public Motorized Travel
-  USFS Not Open to Public Motorized Travel (Designated Seasonal Use April 1 - November 18)
-  USFS Roads (Temporary Widening)
-  USFS Roads Used for Access (No Widening)
-  Public and Private Roads across Private Land (Temporary Widening; includes Dirt Roads)
-  Public and Private Roads Used for Access (No Widening)
-  Public and Private Road
-  Fence

Existing Transmission Routes

-  120 kV Transmission Line
-  345 kV Transmission Line

Land Ownership

-  U.S. Bureau of Land Management
-  U.S. Forest Service
-  California Department of Fish & Wildlife
-  Assessor's Parcel on Private Land
-  State Boundary
-  Staging Areas



**Bordertown to California 120 kV
Transmission Line Project
Construction and Access Mapbook**



Sierra County, CA &
Washoe County, NV
NAD 1983 UTM Zone 11N

PROJECT NO: 203703160
DRAWN BY: CJ
1ST REVIEW: JT
2ND REVIEW: KC
DATE: 1/7/2020

**Map Book
Legend**

PROPERTY OWNERSHIP

Sheet #	APN	Last Name
1	8111005	LIFESTYLE HOMES TND LLC
1	8111004	LIFESTYLE HOMES TND LLC
1	21090002	UNITED STATES OF AMERICA
1	21100012	CONSERVANCY TRUST
2	8111004	LIFESTYLE HOMES TND LLC
2	8101018	HEINZ RANCH LAND COMPANY LLC
2	8101010	UNITED STATES OF AMERICA
2	8111005	LIFESTYLE HOMES TND LLC
2	8111006	LIFESTYLE HOMES TND LLC
3	8101003	UNITED STATES OF AMERICA
3	55801003	GUSTAFSON
3	55801002	MENTOR INVESTMENTS LLC
3	8101006	LIFESTYLE HOMES TND LLC
3	8101018	HEINZ RANCH LAND COMPANY LLC
3	8101010	UNITED STATES OF AMERICA
4	8101001	UNITED STATES OF AMERICA
4	8101003	UNITED STATES OF AMERICA
4	8101004	UNITED STATES OF AMERICA
4	8101005	UNITED STATES OF AMERICA
4	8105046	UNITED STATES OF AMERICA
4	8101006	LIFESTYLE HOMES TND LLC
5	8105011	KING
5	8105046	UNITED STATES OF AMERICA
6	8105046	UNITED STATES OF AMERICA
6	8107029	UNITED STATES OF AMERICA
7	8107020	GEORGE
7	8107029	UNITED STATES OF AMERICA
7	8105046	UNITED STATES OF AMERICA
7	8107019	COX
8	8107006	UNITED STATES OF AMERICA
8	8117009	RUBINSTEIN TRUST
8	8107029	UNITED STATES OF AMERICA
8	8107010	BJORKMAN
8	8117010	CHURCHILL TRUST
9	8117010	CHURCHILL TRUST
9	3801005	LUCAS
9	8107010	BJORKMAN
9	3801010	KRONISH TRUST

Sheet #	APN	Last Name
10	3801007	EMERY
10	3801010	KRONISH TRUST
10	3828040	RIVER BEND INVESTMENTS LLC
10	3828043	SIERRA PACIFIC POWER CO
10	3828041	OLIVER TRUST
10	3828042	HOTEL-CASINO MANAGEMENT INC
10	3855044	FERRONI FOUNDATION
10	3801005	LUCAS
10	3883010	D R HORTON INC
11	3804314	KRONISH TRUST
11	3884104	HERSCHBACH TRUST
11	3804521	ALTMAN
11	3804420	FARRELL TRUST
11	3884204	HARRIGAN IRREVOCABLE TRUST
11	3804221	BUUS TRUST
11	3884103	HERSCHBACH TRUST
11	3804220	SIERRA PACIFIC POWER CO
11	3804437	CUSHMAN FAMILY TRUST
11	3882201	SKAMEL
11	3804540	LOPEY
11	3804316	DEVINE
11	3804406	SIERRA PACIFIC POWER CO
11	3804315	DEVINE
11	3804434	CHUSHMAN FAMILY TRUST
11	3805422	KRONISH TESTAMENTARY TRUST
11	3806037	SIERRA PACIFIC POWER CO
11	3806027	WASHOE CO. SCHOOL DISTRICT BOARD
11	3828066	MFT LIVING TRUST
11	3828069	MFT LIVING TRUST
11	3884215	PIONEER INN ASSOC LTD PTSP
11	3882120	SMALL LLC
11	3884203	SIERRA PACIFIC POWER CO
11	3828039	RIVER BEND INVESTMENTS LLC
11	3828040	RIVER BEND INVESTMENTS LLC
11	3828043	SIERRA PACIFIC POWER CO
11	3806012	SIERRA PACIFIC POWER CO
11	230800110	PIONEER INN ASSOC LTD PARTNER
11	230800260	FERRONI
11	230700720	KRONE
11	231500070	SIERRA PACIFIC POWER CO

Supplemental APN Map	APN	Last Name
1	3804406	SIERRA PACIFIC POWER CO
1	3804420	FARRELL TRUST
1	3804314	KRONISH TRUST
1	3804540	LOPEY
1	3804521	ALTMAN
1	3804546	SIERRA PACIFIC POWER CO
1	3806027	WASHOE CO. SCHOOL DISTRICT BOARD
1	3806037	SIERRA PACIFIC POWER CO
1	3828066	MFT LIVING TRUST
1	3828069	MFT LIVING TRUST
1	3828042	HOTEL-CASINO MANAGEMENT INC
1	3828039	RIVER BEND INVESTMENTS LLC
1	3828040	RIVER BEND INVESTMENTS LLC
1	3828041	OLIVER TRUST
1	3828043	SIERRA PACIFIC POWER CO
1	3828044	HOTEL-CASINO MANAGEMENT INC
1	3883010	D R HORTON INC
1	3804437	CUSHMAN FAMILY TRUST
1	3804417	FARREL TRUST
1	3806012	SIERRA PACIFIC POWER CO
2	3804220	SIERRA PACIFIC POWER CO
2	3804315	DEVINE
2	3804316	DEVINE
2	3804221	BUUS TRUST
2	3805422	KRONISH TESTAMENTARY TRUST
2	3884215	PIONEER INN ASSOC LTD PTSP
2	3882120	SMALL LLC
2	3884203	SIERRA PACIFIC POWER CO
2	3884204	HARRIGAN IRREVOCABLE TRUST
2	3882201	SKAMEL
2	230800260	FERRONI
2	230700720	KRONE
2	230800110	PIONEER INN ASSOC LTD PARTNER
2	231500070	SIERRA PACIFIC POWER CO

V:\2023\Active\203703160\03_data\gls_cad\gis\mxd\Map_Books\Construction_and_Access_Mapbook\Construction_Access_Supplemental_Map_Top_11x17L.mxd Revised: 2020-01-22 By: chrjbjmson

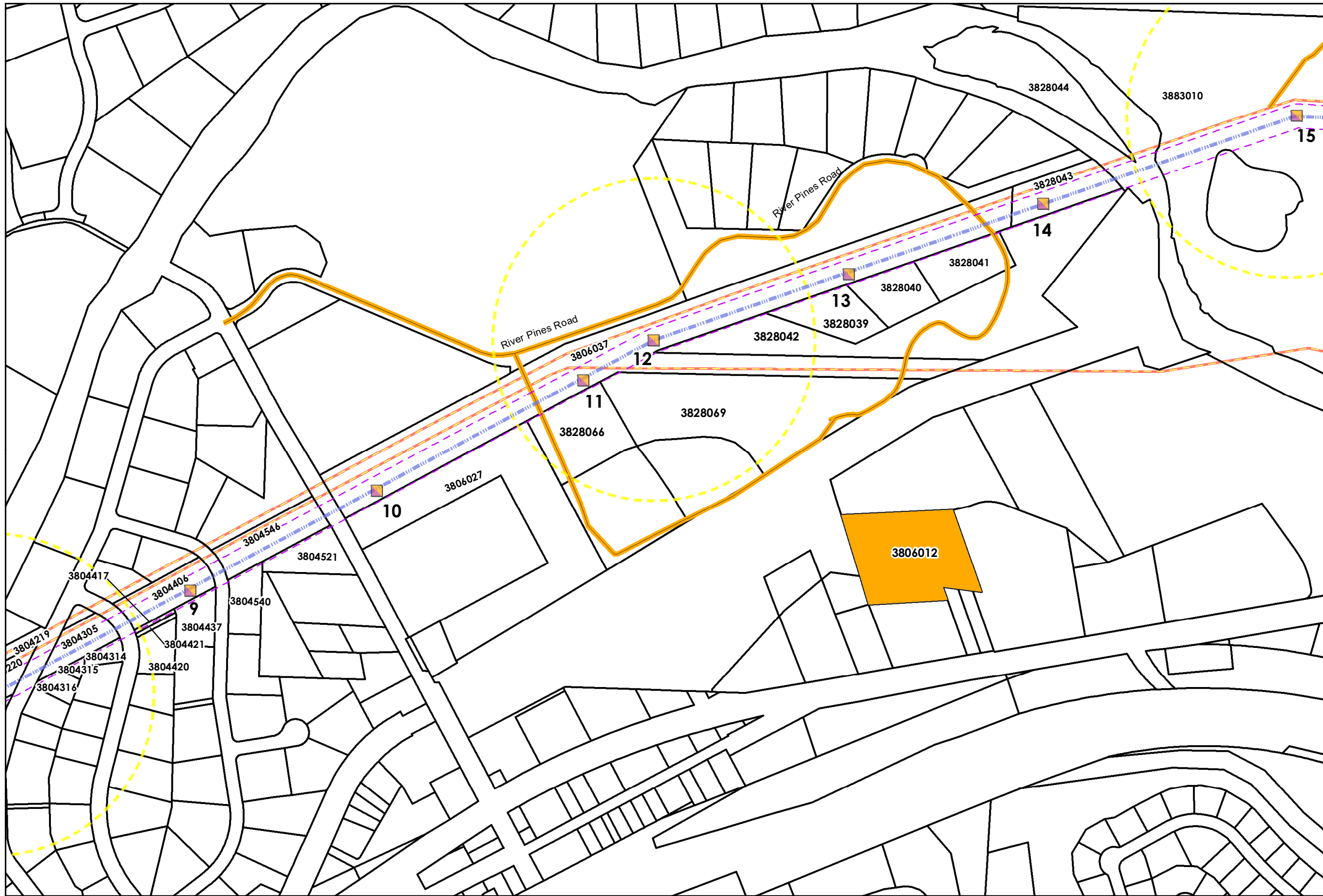

**Bordertown to California 120 kV
Transmission Line Project
Construction and Access Mapbook**

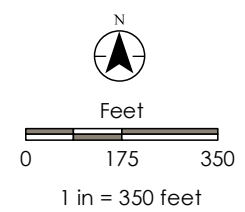

Sierra County, CA &
Washoe County, NV
NAD 1983 UTM Zone 11N

PROJECT NO: 203703160
DRAWN BY: CJ
1ST REVIEW: JT
2ND REVIEW: KC
DATE: 1/22/2020

Supplemental
APN Map
Page 1 of 2

V:\2023\Active\203703160\03_adra\gls_cad\gls\mxd\Map_Books\Construction_and_Access_Mapbook\Construction_Access_Supplemental_Map_Topo_11x17L.mxd Revised: 2020-01-22 By: chrjohmson

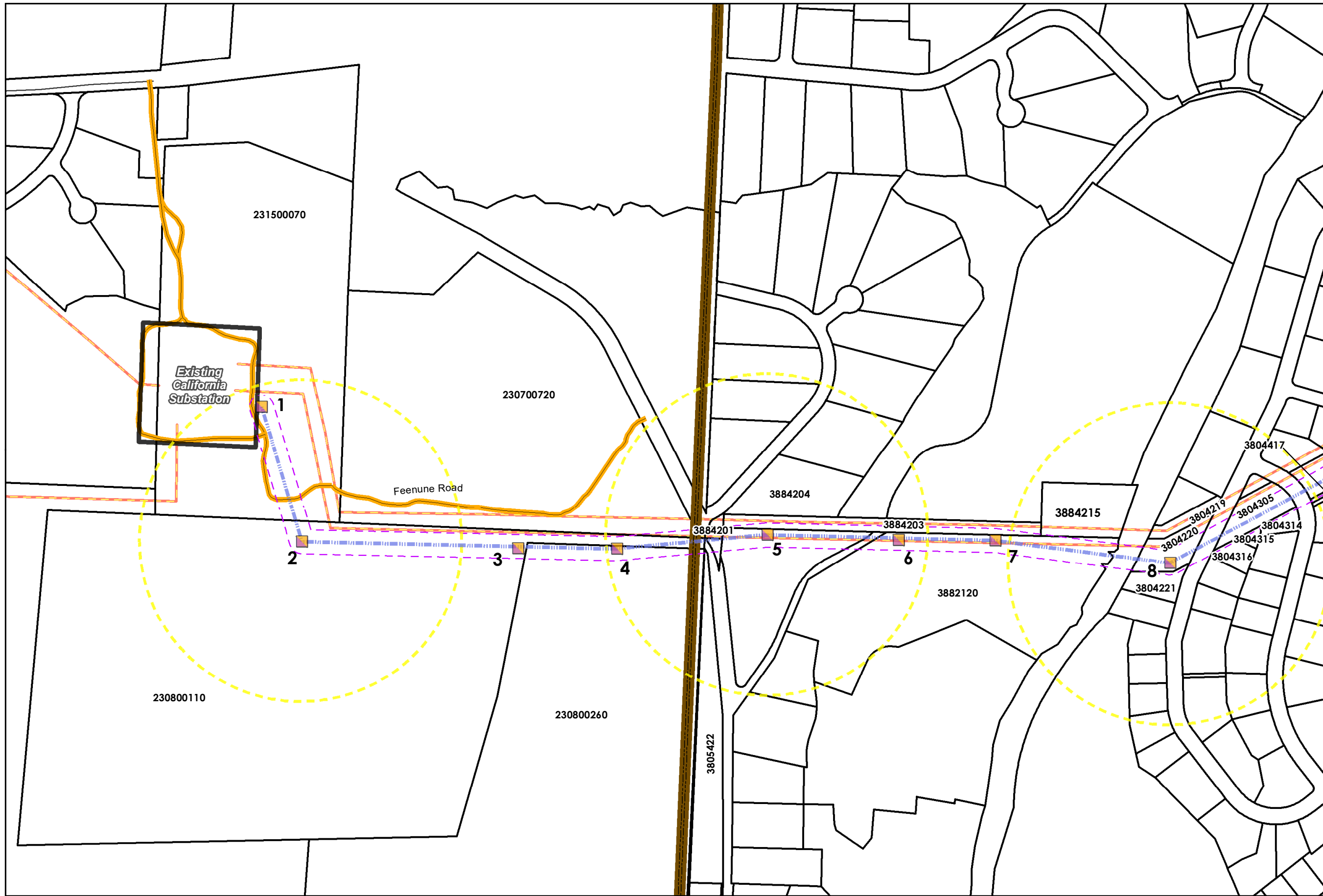

**Bordertown to California 120 kV
Transmission Line Project
Construction and Access Mapbook**

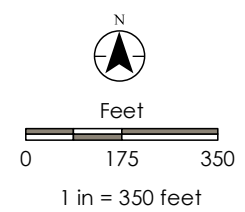

Sierra County, CA &
Washoe County, NV
NAD 1983 UTM Zone 11N

PROJECT NO: 203703160
DRAWN BY: CJ
1ST REVIEW: JT
2ND REVIEW: KC
DATE: 1/22/2020

Supplemental
APN Map
Page 2 of 2

V:\2023\Active\203703160\03_data\gis_cad\gis\mxd\Map_Books\Construction_and_Access_Mapbook\Construction_Access_Mapbook_Aerial_V2_11x17L.mxd Revised: 2020-05-11 By: christhmsn

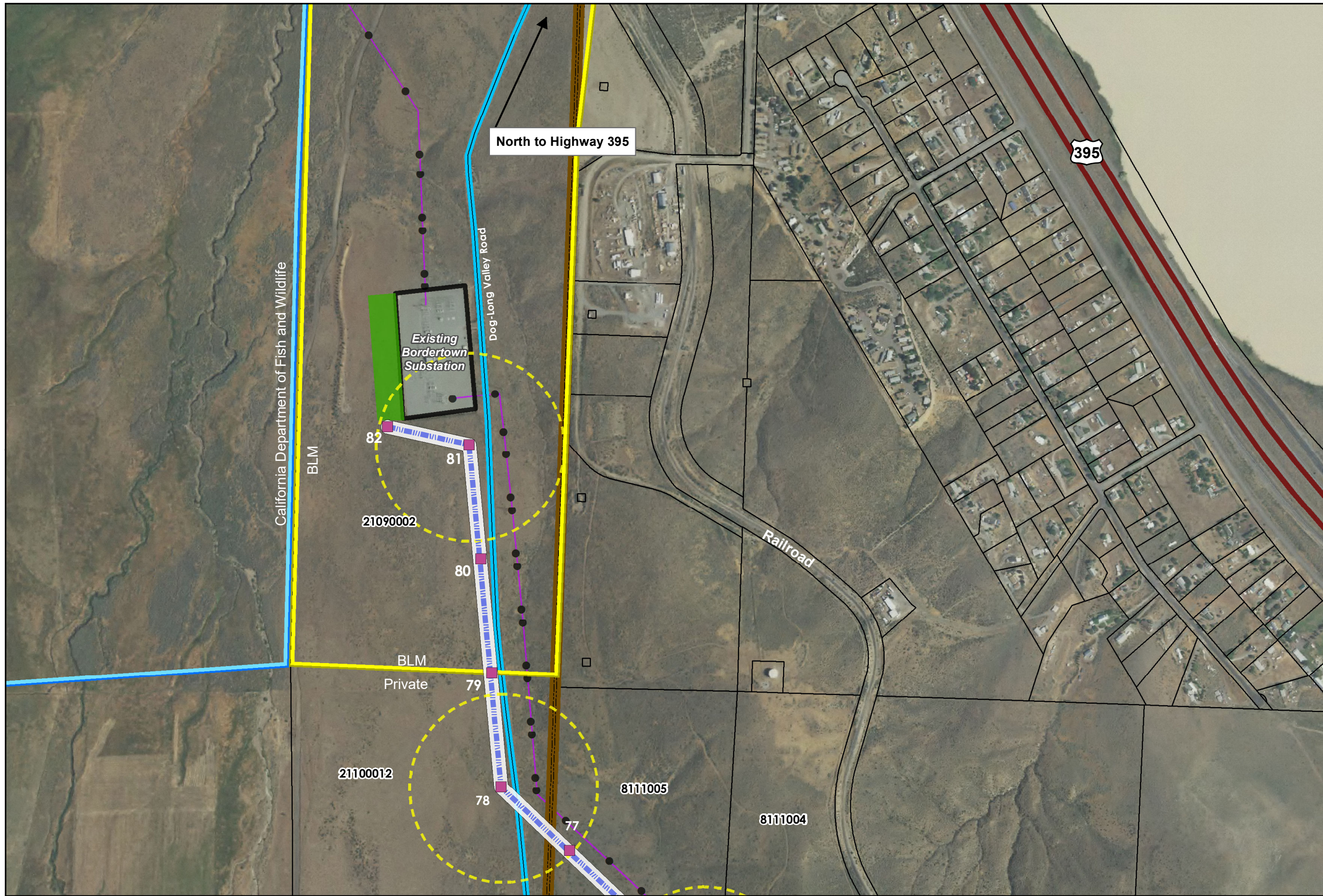

**Bordertown to California 120 kV
Transmission Line Project
Construction and Access Mapbook**

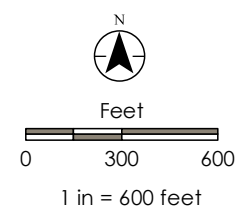

Sierra County, CA &
Washoe County, NV
NAD 1983 UTM Zone 11N

PROJECT NO: 203703160
DRAWN BY: CJ
1ST REVIEW: JT
2ND REVIEW: KC
DATE: 5/11/2020

1
OF 11 SHEETS

V:\2037\Active\203703160\03_data\gls_cad\gls\mxd\Map_Books\Construction_and_Access_Mapbook\Construction_Access_Mapbook_Aerial_V2_11x17L.mxd Reviewed: 2020-05-11 By: christjohmson

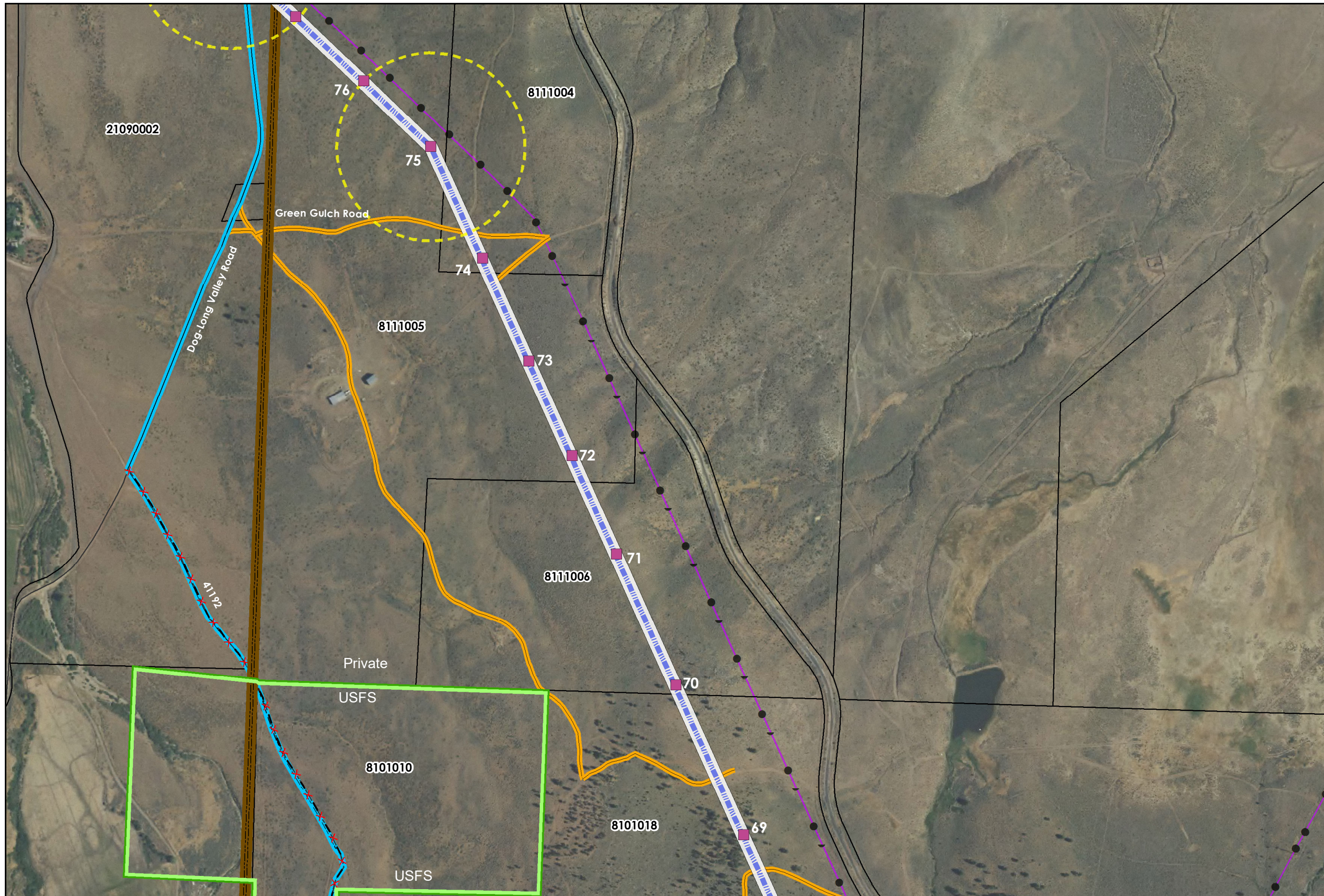

Bordertown to California 120 kV Transmission Line Project Construction and Access Mapbook

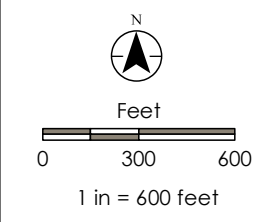

Sierra County, CA &
Washoe County, NV
NAD 1983 UTM Zone 11N

PROJECT NO: 203703160
DRAWN BY: CJ
1ST REVIEW: JT
2ND REVIEW: KC
DATE: 5/11/2020

Disclaimer: Stantec assumes no responsibility for data supplied in electronic format. The recipient accepts full responsibility for verifying the accuracy and completeness of the data. The recipient releases Stantec, its officers, employees, consultants and agents, from any and all claims arising in any way from the content or provision of the data.

Service Layer Credits:

V:\2023\Active\203703160\03_data\gis\cad\gis\mxd\Map_Books\Construction_and_Access_Mapbook\Construction_Access_Mapbook_Aerial_V2_11x17L.mxd Revised: 2020-01-22 By: chrjbmson

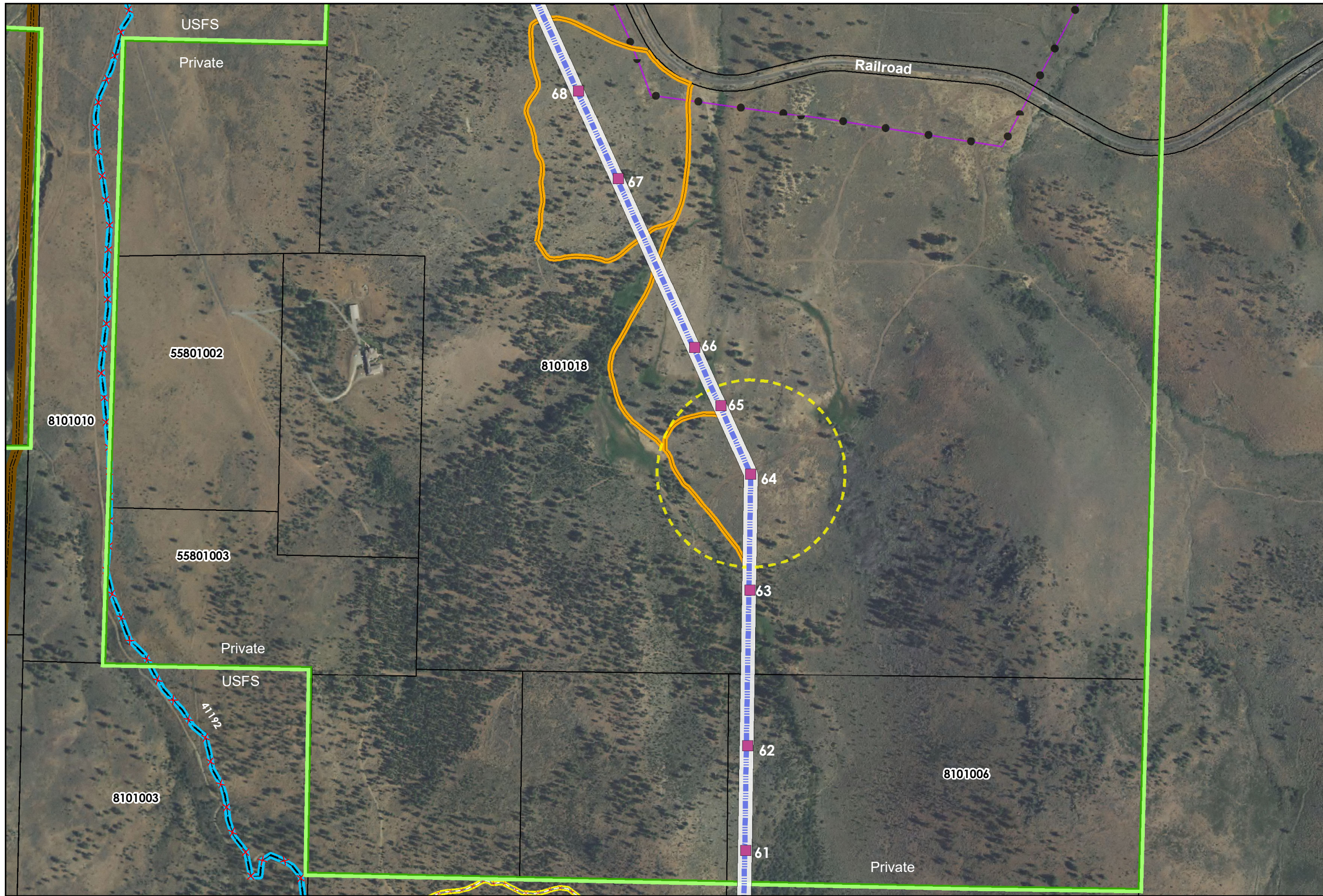

**Bordertown to California 120 kV
Transmission Line Project
Construction and Access Mapbook**

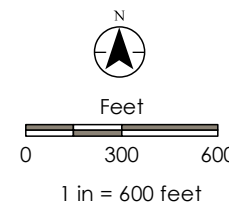

Sierra County, CA &
Washoe County, NV
NAD 1983 UTM Zone 11N

PROJECT NO: 203703160
DRAWN BY: CJ
1ST REVIEW: JT
2ND REVIEW: KC
DATE: 1/22/2020

Disclaimer: Stantec assumes no responsibility for data supplied in electronic format. The recipient accepts full responsibility for verifying the accuracy and completeness of the data. The recipient releases Stantec, its officers, employees, consultants and agents, from any and all claims arising in any way from the content or provision of the data.

Service Layer Credits:

V:\2023\Active\203703160\03_data\gls_cad\gls\mxd\Map_Books\Construction_and_Access_Mapbook\Construction_Access_Mapbook_Aerial_V2_11x17L.mxd Revised: 2020-01-22 By: christhmsn



**Bordertown to California 120 kV
Transmission Line Project
Construction and Access Mapbook**

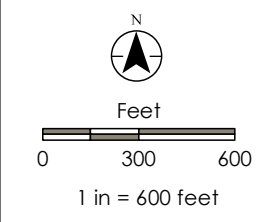

Sierra County, CA &
Washoe County, NV
NAD 1983 UTM Zone 11N

PROJECT NO: 203703160
DRAWN BY: CJ
1ST REVIEW: JT
2ND REVIEW: KC
DATE: 1/22/2020

Disclaimer: Stantec assumes no responsibility for data supplied in electronic format. The recipient accepts full responsibility for verifying the accuracy and completeness of the data. The recipient releases Stantec, its officers, employees, consultants and agents, from any and all claims arising in any way from the content or provision of the data.

Service Layer Credits:

V:\2023\Active\203703160\03_data\gis_cad\gis\mxd\Map_Books\Construction_and_Access_Mapbook\Construction_Access_Mapbook_Aerial_V2_11x17L.mxd Revised: 2020-01-22 By: christjohmson

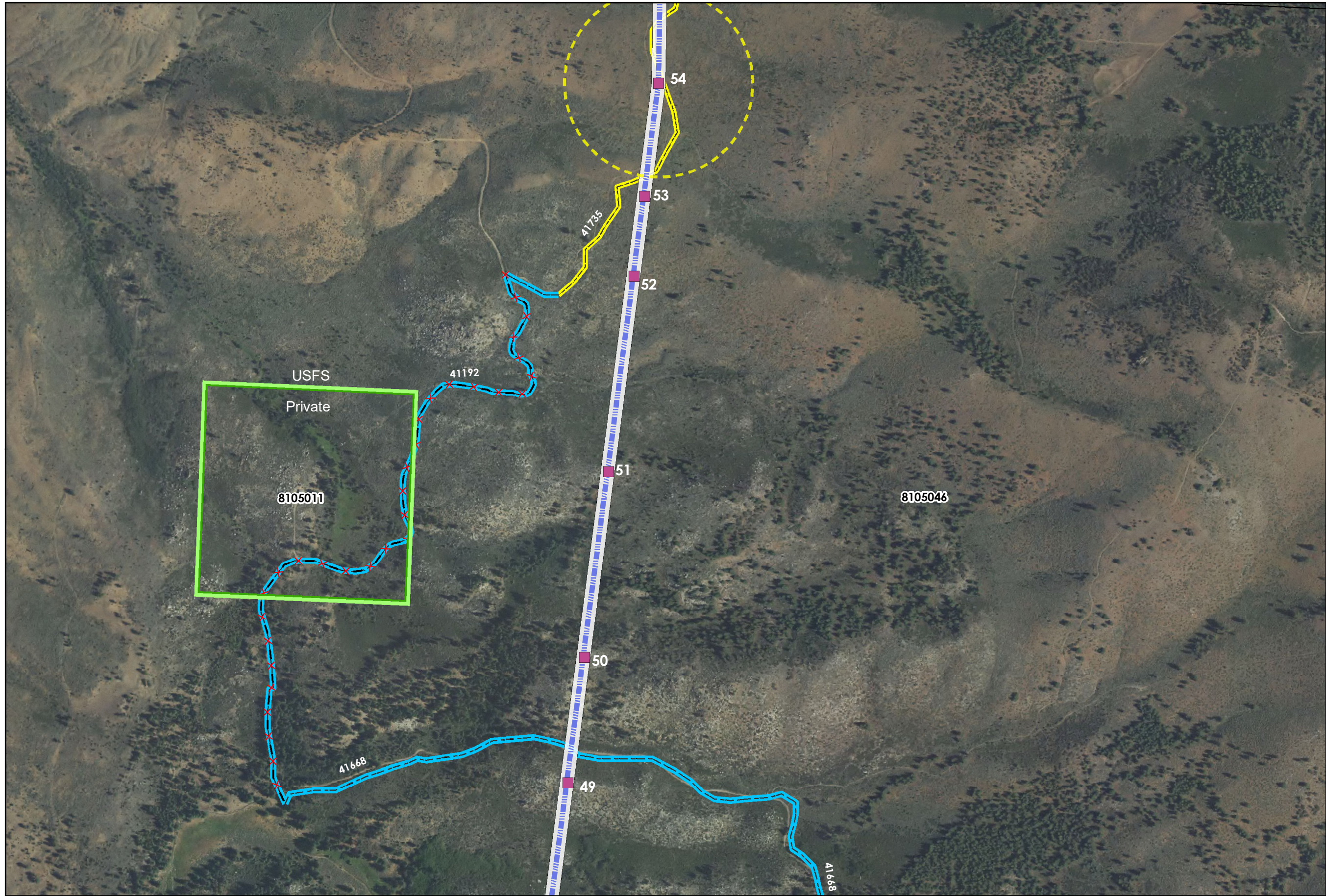

**Bordertown to California 120 kV
Transmission Line Project
Construction and Access Mapbook**

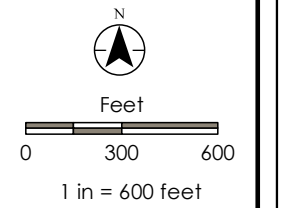

Sierra County, CA &
Washoe County, NV
NAD 1983 UTM Zone 11N

PROJECT NO: 203703160
DRAWN BY: CJ
1ST REVIEW: JT
2ND REVIEW: KC
DATE: 1/22/2020

5
OF 11 SHEETS

V:\2037\Active\203703160\03_data\gis_cad\gis\mxd\Map_Books\Construction_and_Access_Mapbook\Construction_Access_Mapbook_Aerial_V2_11x17L.mxd Revised: 2020-01-22 By: christhinson

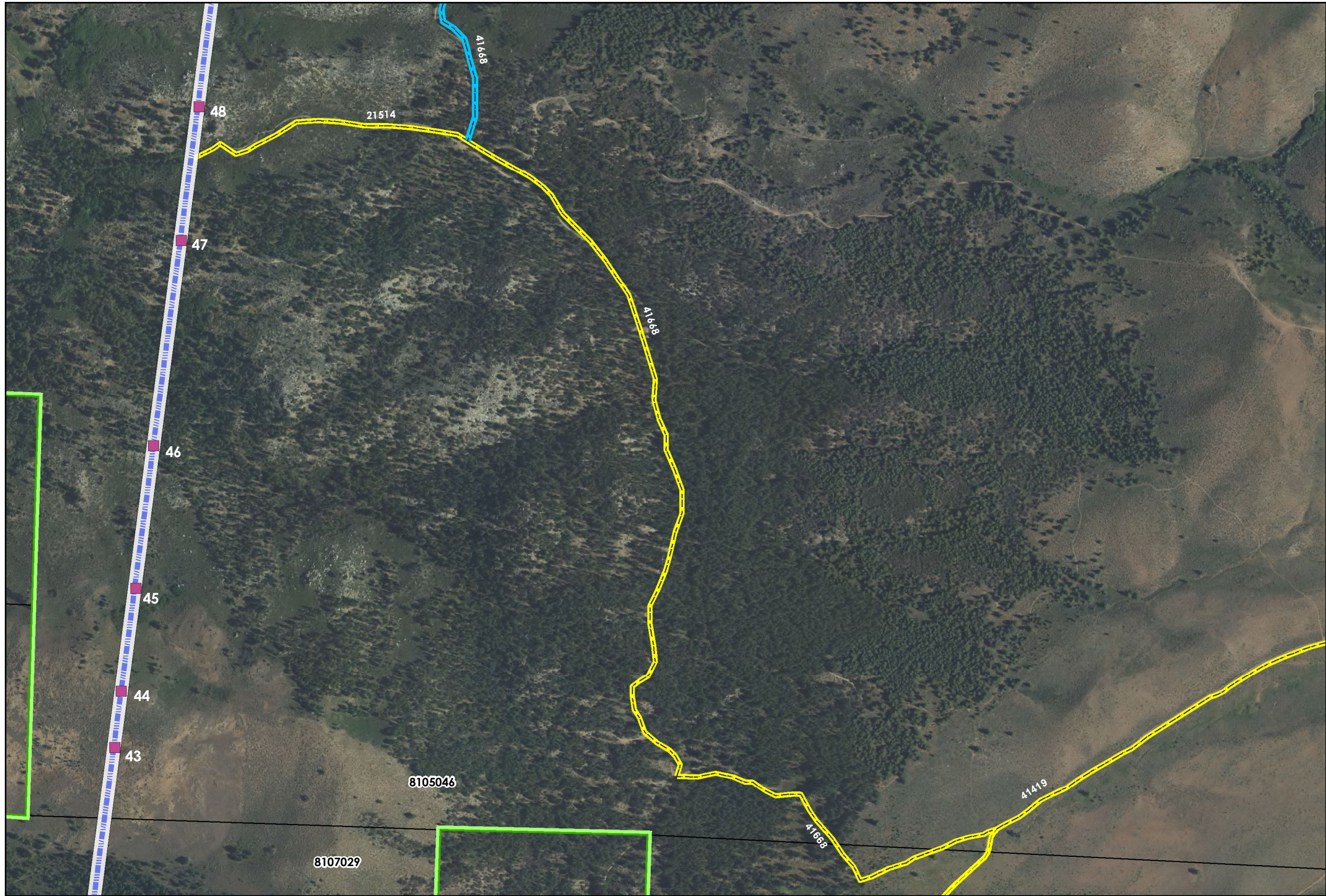

**Bordertown to California 120 kV
Transmission Line Project
Construction and Access Mapbook**

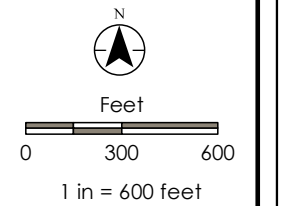

Sierra County, CA &
Washoe County, NV
NAD 1983 UTM Zone 11N

PROJECT NO: 203703160
DRAWN BY: CJ
1ST REVIEW: JT
2ND REVIEW: KC
DATE: 1/22/2020

6
OF 11 SHEETS

V:\2020\Active\203703160\03_data\gls_cad\gls\mxd\Map_Books\Construction_and_Access_Mapbook\Construction_Access_Mapbook_Aerial_V2_11x17L.mxd Revised: 2020-01-22 By: chrjohmson

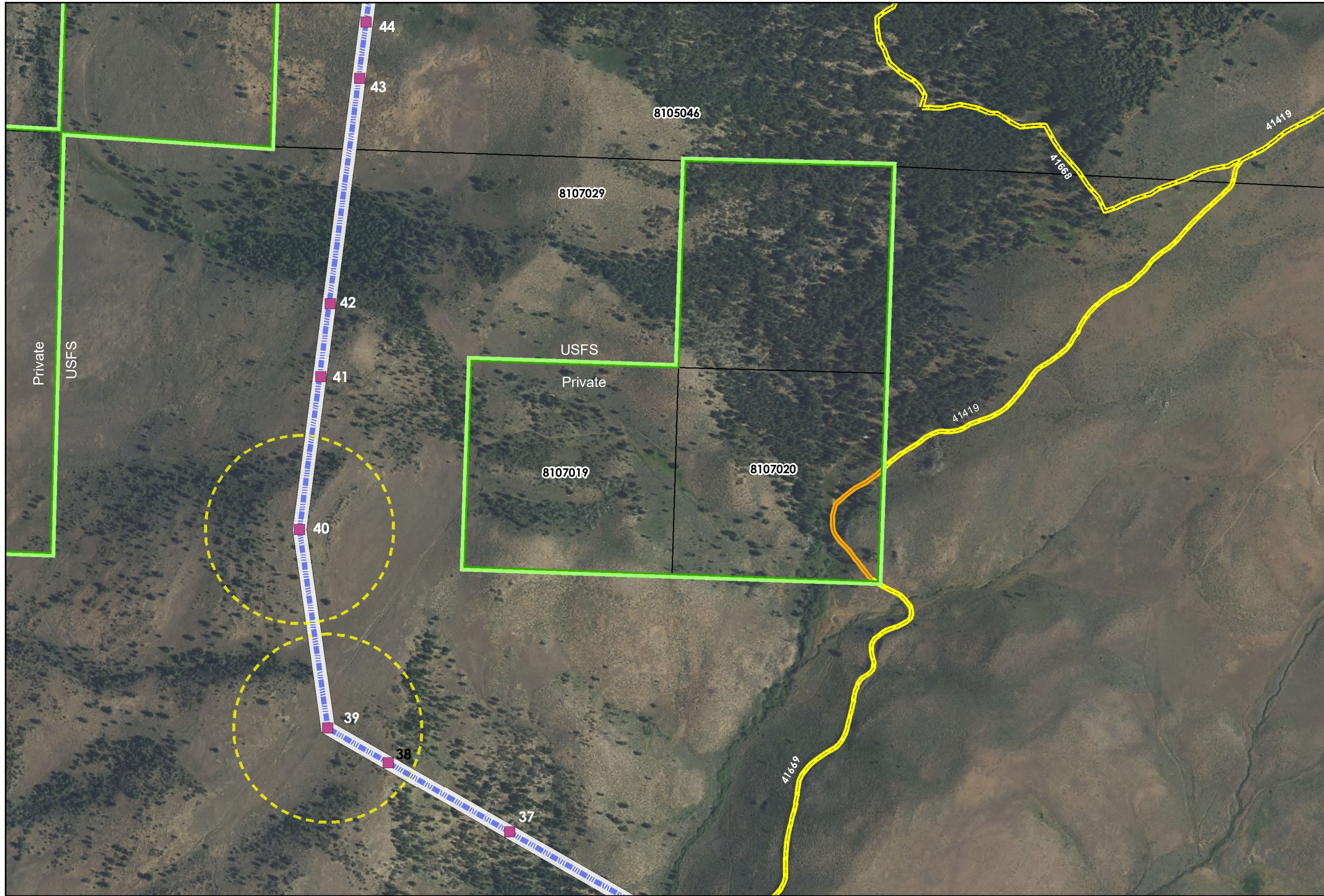

**Bordertown to California 120 kV
Transmission Line Project
Construction and Access Mapbook**

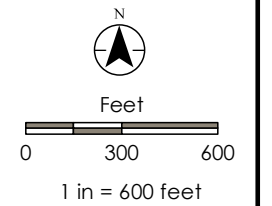

Sierra County, CA &
Washoe County, NV
NAD 1983 UTM Zone 11N

PROJECT NO: 203703160
DRAWN BY: CJ
1ST REVIEW: JT
2ND REVIEW: KC
DATE: 1/22/2020

7
OF 11 SHEETS

V:\2023\Active\203703160\03_adra\gls_cad\gls\mxd\Map_Books\Construction_and_Access_Mapbook\Construction_Access_Mapbook_Aerial_V2_11x17L.mxd Reviewed: 2020-01-22 By: christhmsn



Bordertown to California 120 kV Transmission Line Project Construction and Access Mapbook

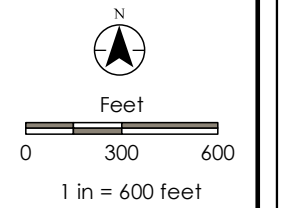

Sierra County, CA &
Washoe County, NV
NAD 1983 UTM Zone 11N

PROJECT NO: 203703160
DRAWN BY: CJ
1ST REVIEW: JT
2ND REVIEW: KC
DATE: 1/22/2020

8
OF 11 SHEETS

V:\2037\Active\203703160\03_data\gls_cad\gls\mxd\Map_Books\Construction_and_Access_Mapbook\Construction_Access_Mapbook_Aerial_V2_11x17L.mxd Revised: 2020-01-22 By: chrjbrnson

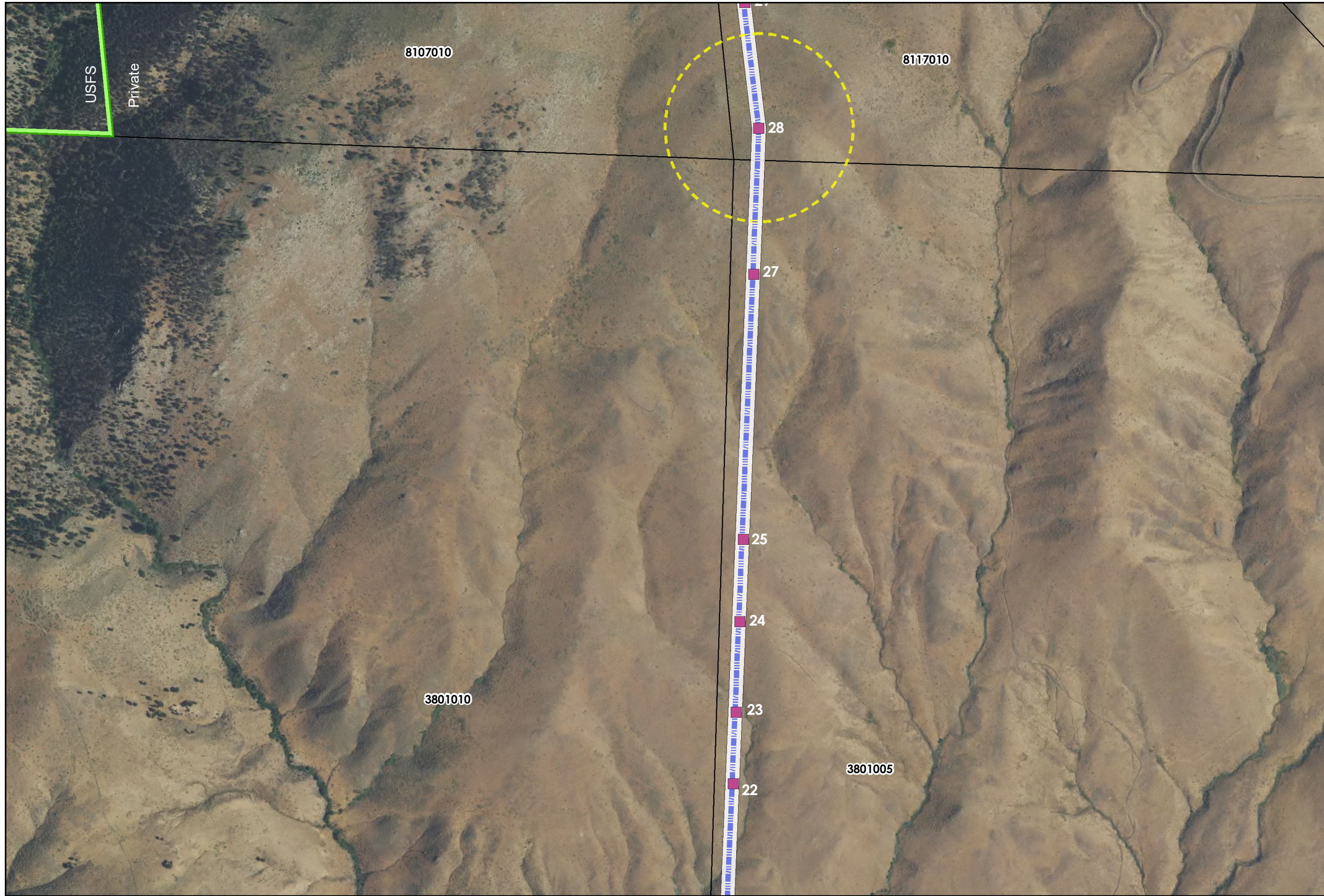

**Bordertown to California 120 kV
Transmission Line Project
Construction and Access Mapbook**

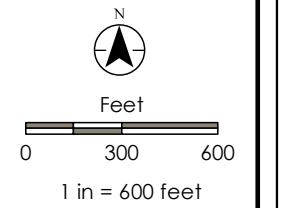

Sierra County, CA &
Washoe County, NV
NAD 1983 UTM Zone 11N

PROJECT NO: 203703160
DRAWN BY: CJ
1ST REVIEW: JT
2ND REVIEW: KC
DATE: 1/22/2020

9
OF 11 SHEETS

V:\2037\Active\203703160\03_data\gis\mxd\Map_Books\Construction_and_Access_Mapbook\Construction_Access_Mapbook_Aerial_V2_11x17L.mxd Revised: 2020-01-22 By: christhmsn



**Bordertown to California 120 kV
Transmission Line Project
Construction and Access Mapbook**

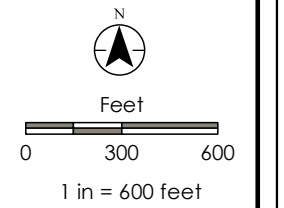

Sierra County, CA &
Washoe County, NV
NAD 1983 UTM Zone 11N

PROJECT NO: 203703160
DRAWN BY: CJ
1ST REVIEW: JT
2ND REVIEW: KC
DATE: 1/22/2020

10
OF 11 SHEETS

V:\2023\Active\203703160\03_dra\gls_cad\gls\mxd\Map_Books\Construction_and_Access_Mapbook\Construction_Access_Mapbook_Aerial_V2_11x17L.mxd Revised: 2020-01-22 By: christhompson

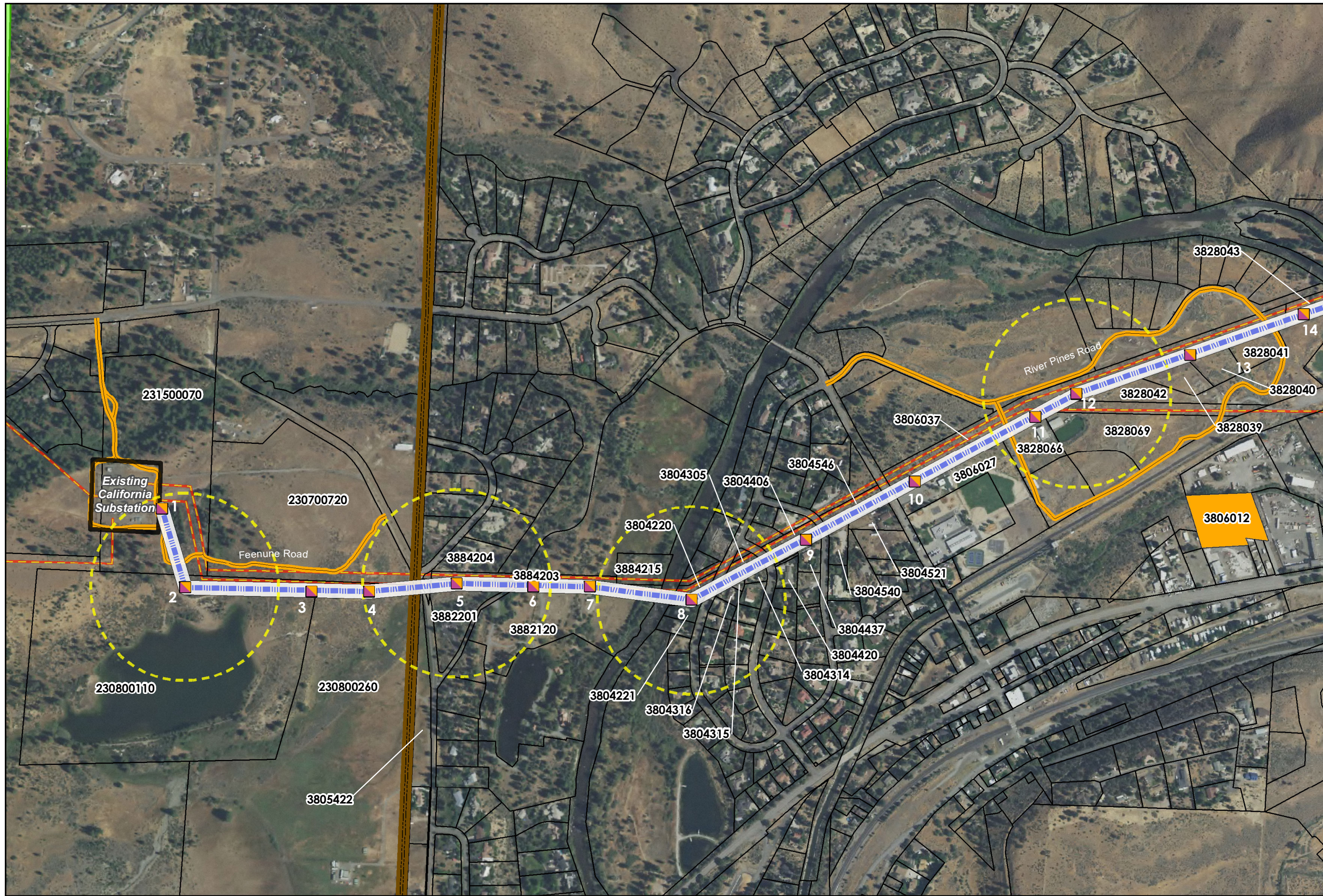

Bordertown to California 120 kV Transmission Line Project Construction and Access Mapbook

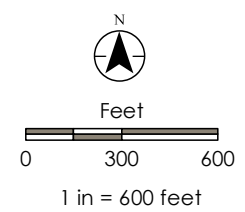

Sierra County, CA &
Washoe County, NV
NAD 1983 UTM Zone 11N

PROJECT NO: 203703160
DRAWN BY: CJ
1ST REVIEW: JT
2ND REVIEW: KC
DATE: 1/22/2020

11

OF 11 SHEETS

V:\2023\Active\203703160_03_dtd\gls\mxd\Map_Books\Construction_and_Access_Mapbook\Cover_Page_Top_11x17.mxd Reviewed: 2020-05-12 By: christopher

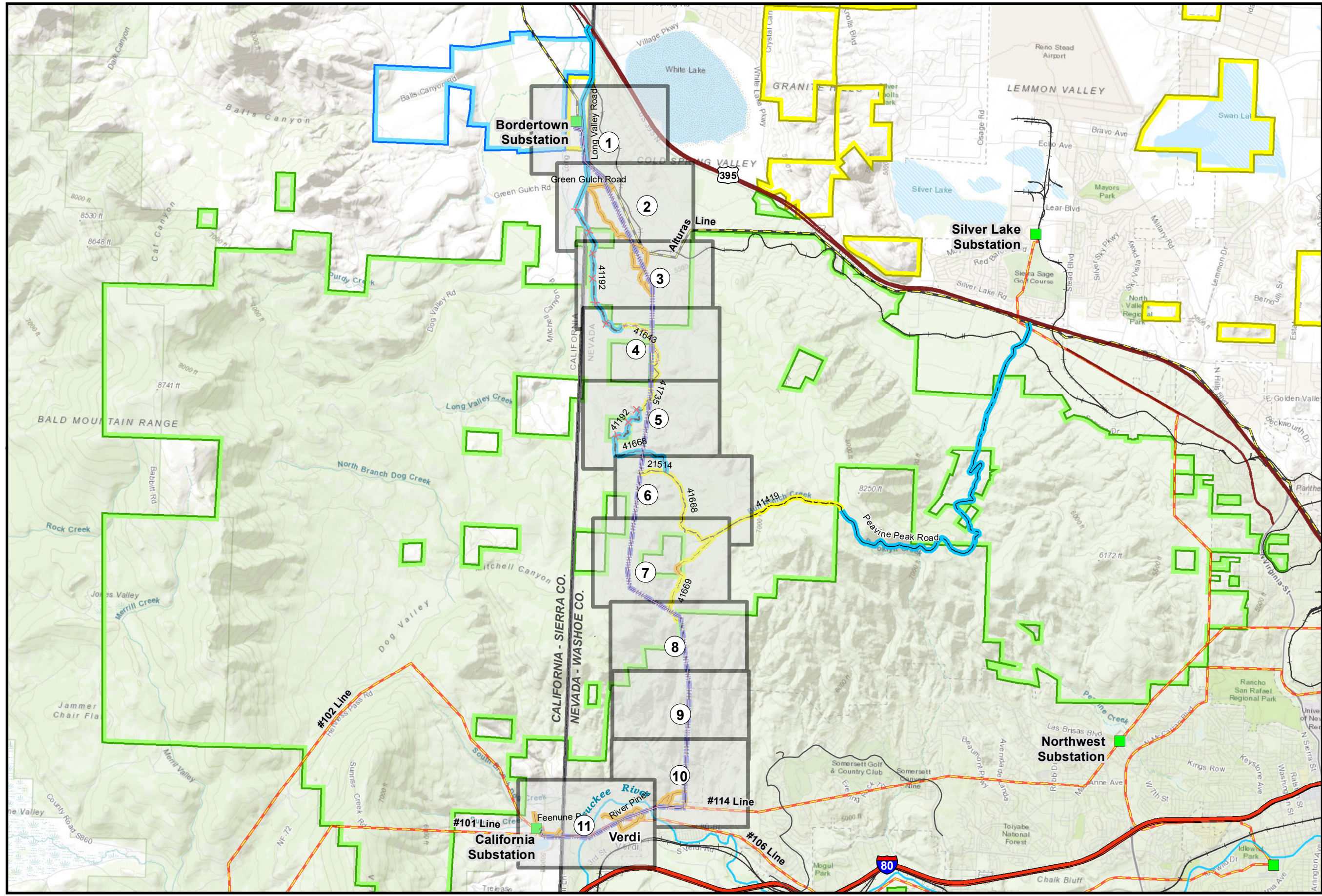

Bordertown to California 120 kV Transmission Line Project Construction and Access Mapbook

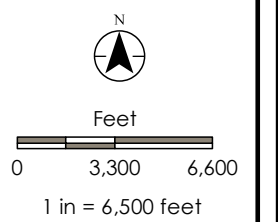

Sierra County, CA &
Washoe County, NV
NAD 1983 UTM Zone 11N

PROJECT NO: 203703160
DRAWN BY: CJ
1ST REVIEW: JT
2ND REVIEW: KC
DATE: 5/12/2020

**MAP BOOK
COVER PAGE**







Disclaimer: Stantec assumes no responsibility for data supplied in electronic format. The recipient accepts full responsibility for verifying the accuracy and completeness of the data. The recipient releases Stantec, its officers, employees, consultants and agents, from any and all claims arising in any way from the content or provision of the data.

Service Layer Credits: Sources: Esri, HERE, Garmin, Intermap, increment P Corp., GBSCO, USGS, FAO, NPS, NRCAN, Geobase, IGN, Kadaster NL, Ordnance Survey, Esri Japan, METI, Esri China (Hong Kong), Swisstopo, Mapbox Contributors, and the GIS User Community











V:\2037\Active\203703160\03_data\gls_cad\gls\mxd\Map_Books\Construction_and_Access_Mapbook\Construction_Map_Book_Legend.mxd Reviewed: 2020-01-07 By: chjohnson

How to Use This Map Book



This Map Book is intended as the pictorial reference for the construction and access for the Bordertown to California 120 kV Transmission Line Project. Each map sheet is the Centerline Construction and Access Map overlaid on an aerial and topographic photo background depicting Land Ownership, Access, and Construction Vehicle Travel.

-  Peavine\Poeville Alignment
-  90-ft ROW
-  Existing Substation
-  Addition to Substation
-  New Pole Structure
-  New Pole Structure/Existing Pole To Be Removed
-  Wire Set-up Site







Roads

-  USFS Roads
-  USFS Road (Designated Seasonal Use April 1 - November 18)
-  USFS Road Not Open to Public Motorized Travel
-  USFS Not Open to Public Motorized Travel (Designated Seasonal Use April 1 - November 18)
-  USFS Roads (Temporary Widening)
-  USFS Roads Used for Access (No Widening)
-  Public and Private Roads across Private Land (Temporary Widening; includes Dirt Roads)
-  Public and Private Roads Used for Access (No Widening)
-  Public and Private Road
-  Fence

Existing Transmission Routes

-  120 kV Transmission Line
-  345 kV Transmission Line

Land Ownership

-  U.S. Bureau of Land Management
-  U.S. Forest Service
-  California Department of Fish & Wildlife
-  Assessor's Parcel on Private Land
-  State Boundary
-  Staging Areas



**Bordertown to California 120 kV
Transmission Line Project
Construction and Access Mapbook**



Sierra County, CA &
Washoe County, NV
NAD 1983 UTM Zone 11N

PROJECT NO: 203703160
DRAWN BY: CJ
1ST REVIEW: JT
2ND REVIEW: KC
DATE: 1/7/2020

**Map Book
Legend**

PROPERTY OWNERSHIP

Sheet #	APN	Last Name
1	8111005	LIFESTYLE HOMES TND LLC
1	8111004	LIFESTYLE HOMES TND LLC
1	21090002	UNITED STATES OF AMERICA
1	21100012	CONSERVANCY TRUST
2	8111004	LIFESTYLE HOMES TND LLC
2	8101018	HEINZ RANCH LAND COMPANY LLC
2	8101010	UNITED STATES OF AMERICA
2	8111005	LIFESTYLE HOMES TND LLC
2	8111006	LIFESTYLE HOMES TND LLC
3	8101003	UNITED STATES OF AMERICA
3	55801003	GUSTAFSON
3	55801002	MENTOR INVESTMENTS LLC
3	8101006	LIFESTYLE HOMES TND LLC
3	8101018	HEINZ RANCH LAND COMPANY LLC
3	8101010	UNITED STATES OF AMERICA
4	8101001	UNITED STATES OF AMERICA
4	8101003	UNITED STATES OF AMERICA
4	8101004	UNITED STATES OF AMERICA
4	8101005	UNITED STATES OF AMERICA
4	8105046	UNITED STATES OF AMERICA
4	8101006	LIFESTYLE HOMES TND LLC
5	8105011	KING
5	8105046	UNITED STATES OF AMERICA
6	8105046	UNITED STATES OF AMERICA
6	8107029	UNITED STATES OF AMERICA
7	8107020	GEORGE
7	8107029	UNITED STATES OF AMERICA
7	8105046	UNITED STATES OF AMERICA
7	8107019	COX
8	8107006	UNITED STATES OF AMERICA
8	8117009	RUBINSTEIN TRUST
8	8107029	UNITED STATES OF AMERICA
8	8107010	BJORKMAN
8	8117010	CHURCHILL TRUST
9	8117010	CHURCHILL TRUST
9	3801005	LUCAS
9	8107010	BJORKMAN
9	3801010	KRONISH TRUST

Sheet #	APN	Last Name
10	3801007	EMERY
10	3801010	KRONISH TRUST
10	3828040	RIVER BEND INVESTMENTS LLC
10	3828043	SIERRA PACIFIC POWER CO
10	3828041	OLIVER TRUST
10	3828042	HOTEL-CASINO MANAGEMENT INC
10	3855044	FERRONI FOUNDATION
10	3801005	LUCAS
10	3883010	D R HORTON INC
11	3804314	KRONISH TRUST
11	3884104	HERSCHBACH TRUST
11	3804521	ALTMAN
11	3804420	FARRELL TRUST
11	3884204	HARRIGAN IRREVOCABLE TRUST
11	3804221	BUUS TRUST
11	3884103	HERSCHBACH TRUST
11	3804220	SIERRA PACIFIC POWER CO
11	3804437	CUSHMAN FAMILY TRUST
11	3882201	SKAMEL
11	3804540	LOPEY
11	3804316	DEVINE
11	3804406	SIERRA PACIFIC POWER CO
11	3804315	DEVINE
11	3804434	CHUSHMAN FAMILY TRUST
11	3805422	KRONISH TESTAMENTARY TRUST
11	3806037	SIERRA PACIFIC POWER CO
11	3806027	WASHOE CO. SCHOOL DISTRICT BOARD
11	3828066	MFT LIVING TRUST
11	3828069	MFT LIVING TRUST
11	3884215	PIONEER INN ASSOC LTD PTSP
11	3882120	SMALL LLC
11	3884203	SIERRA PACIFIC POWER CO
11	3828039	RIVER BEND INVESTMENTS LLC
11	3828040	RIVER BEND INVESTMENTS LLC
11	3828043	SIERRA PACIFIC POWER CO
11	3806012	SIERRA PACIFIC POWER CO
11	230800110	PIONEER INN ASSOC LTD PARTNER
11	230800260	FERRONI
11	230700720	KRONE
11	231500070	SIERRA PACIFIC POWER CO

Supplemental APN Map	APN	Last Name
1	3804406	SIERRA PACIFIC POWER CO
1	3804420	FARRELL TRUST
1	3804314	KRONISH TRUST
1	3804540	LOPEY
1	3804521	ALTMAN
1	3804546	SIERRA PACIFIC POWER CO
1	3806027	WASHOE CO. SCHOOL DISTRICT BOARD
1	3806037	SIERRA PACIFIC POWER CO
1	3828066	MFT LIVING TRUST
1	3828069	MFT LIVING TRUST
1	3828042	HOTEL-CASINO MANAGEMENT INC
1	3828039	RIVER BEND INVESTMENTS LLC
1	3828040	RIVER BEND INVESTMENTS LLC
1	3828041	OLIVER TRUST
1	3828043	SIERRA PACIFIC POWER CO
1	3828044	HOTEL-CASINO MANAGEMENT INC
1	3883010	D R HORTON INC
1	3804437	CUSHMAN FAMILY TRUST
1	3804417	FARREL TRUST
1	3806012	SIERRA PACIFIC POWER CO
2	3804220	SIERRA PACIFIC POWER CO
2	3804315	DEVINE
2	3804316	DEVINE
2	3804221	BUUS TRUST
2	3805422	KRONISH TESTAMENTARY TRUST
2	3884215	PIONEER INN ASSOC LTD PTSP
2	3882120	SMALL LLC
2	3884203	SIERRA PACIFIC POWER CO
2	3884204	HARRIGAN IRREVOCABLE TRUST
2	3882201	SKAMEL
2	230800260	FERRONI
2	230700720	KRONE
2	230800110	PIONEER INN ASSOC LTD PARTNER
2	231500070	SIERRA PACIFIC POWER CO

V:\2023\Active\203703160\03_data\gls_cad\gis\mxd\Map_Books\Construction_and_Access_Mapbook\Construction_Access_Supplemental_Map_Top_11x17.mxd Revised: 2020-01-22 By: chrijmson

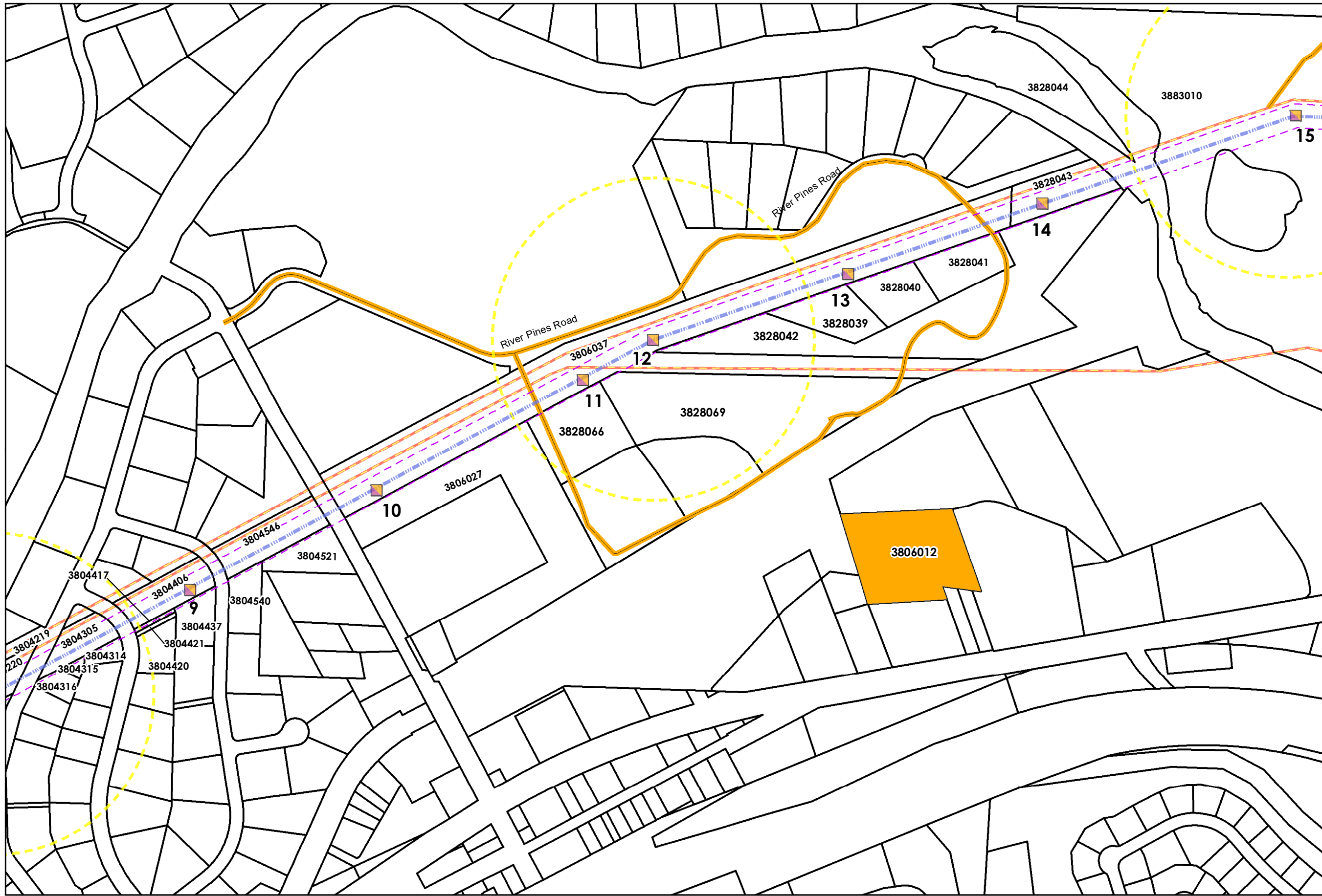

**Bordertown to California 120 kV
Transmission Line Project
Construction and Access Mapbook**

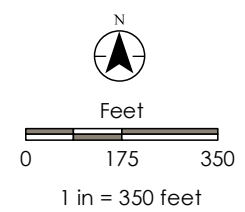

Sierra County, CA &
Washoe County, NV
NAD 1983 UTM Zone 11N

PROJECT NO: 203703160
DRAWN BY: CJ
1ST REVIEW: JT
2ND REVIEW: KC
DATE: 1/22/2020

Supplemental
APN Map
Page 1 of 2

V:\2023\Active\203703160\03_adra\gls_cad\gis\mxd\Map_Books\Construction_and_Access_Mapbook\Construction_Access_Supplemental_Map_Topo_11x17L.mxd Revised: 2020-01-22 By: chrjohmson



Bordertown to California 120 kV Transmission Line Project Construction and Access Mapbook



Feet
0 175 350
1 in = 350 feet

Sierra County, CA &
Washoe County, NV
NAD 1983 UTM Zone 11N

PROJECT NO: 203703160
DRAWN BY: CJ
1ST REVIEW: JT
2ND REVIEW: KC
DATE: 1/22/2020

Supplemental
APN Map
Page 2 of 2

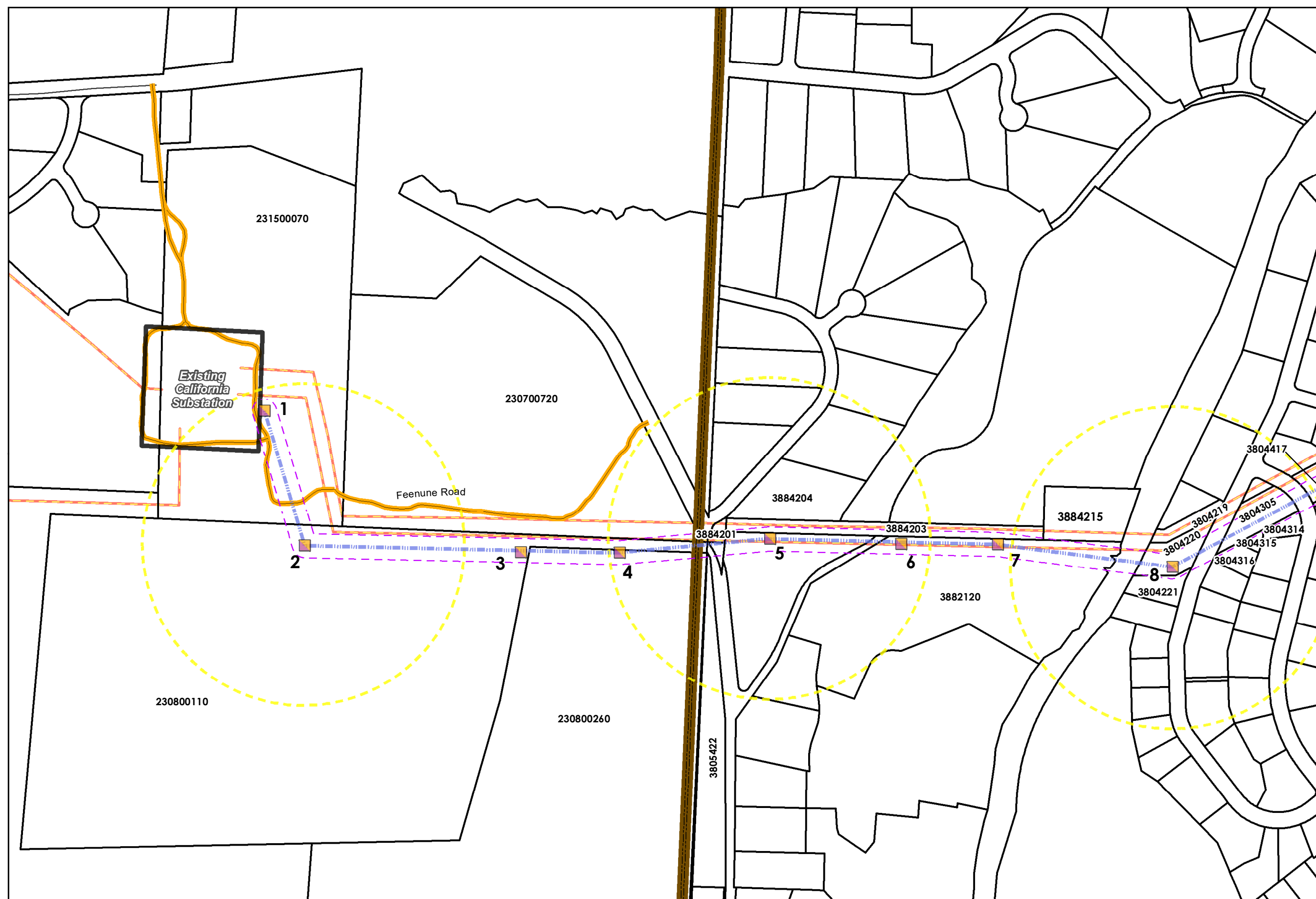

V:\2023\Active\203703160\03_data\vgis_cad\vgis\mxd\Map_Books\Construction_and_Access_Mapbook\Construction_Access_Mapbook_Topo_11x17.mxd Revised: 2020-05-11 By: chiphinson

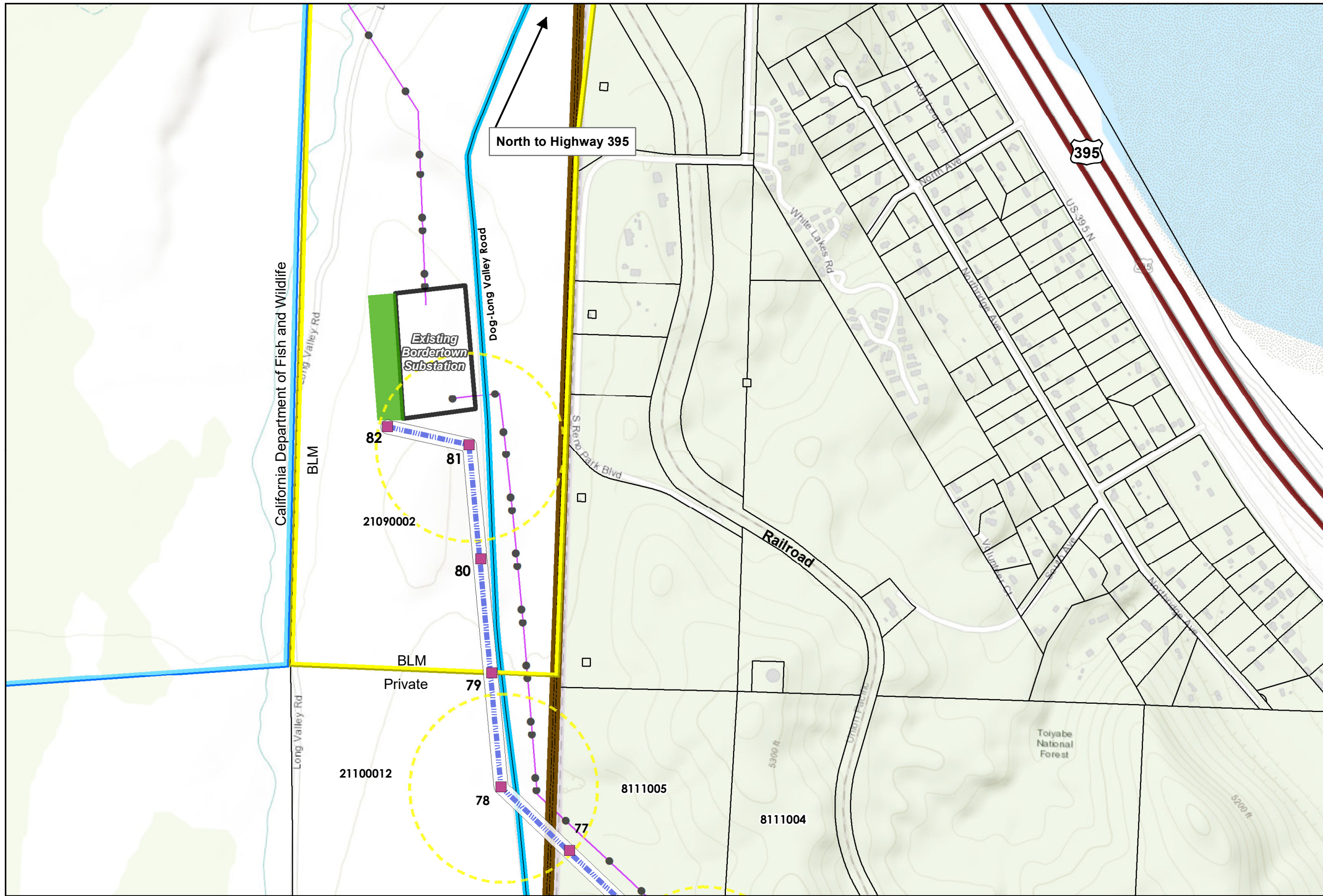

Bordertown to California 120 kV Transmission Line Project Construction and Access Mapbook

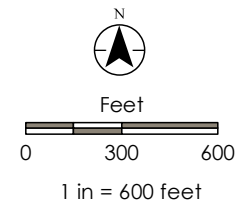

Sierra County, CA &
Washoe County, NV
NAD 1983 UTM Zone 11N

PROJECT NO: 203703160
DRAWN BY: CJ
1ST REVIEW: JT
2ND REVIEW: KC
DATE: 5/11/2020

1
OF 11 SHEETS

V:\2037\Active\203703160\03_data\vgb_cad\vgb.mxd\Map_Books\Construction_and_Access_Mapbook\Construction_Access_Mapbook_Topo_11x17L.mxd Revised: 2020-05-11 By: chiphinson

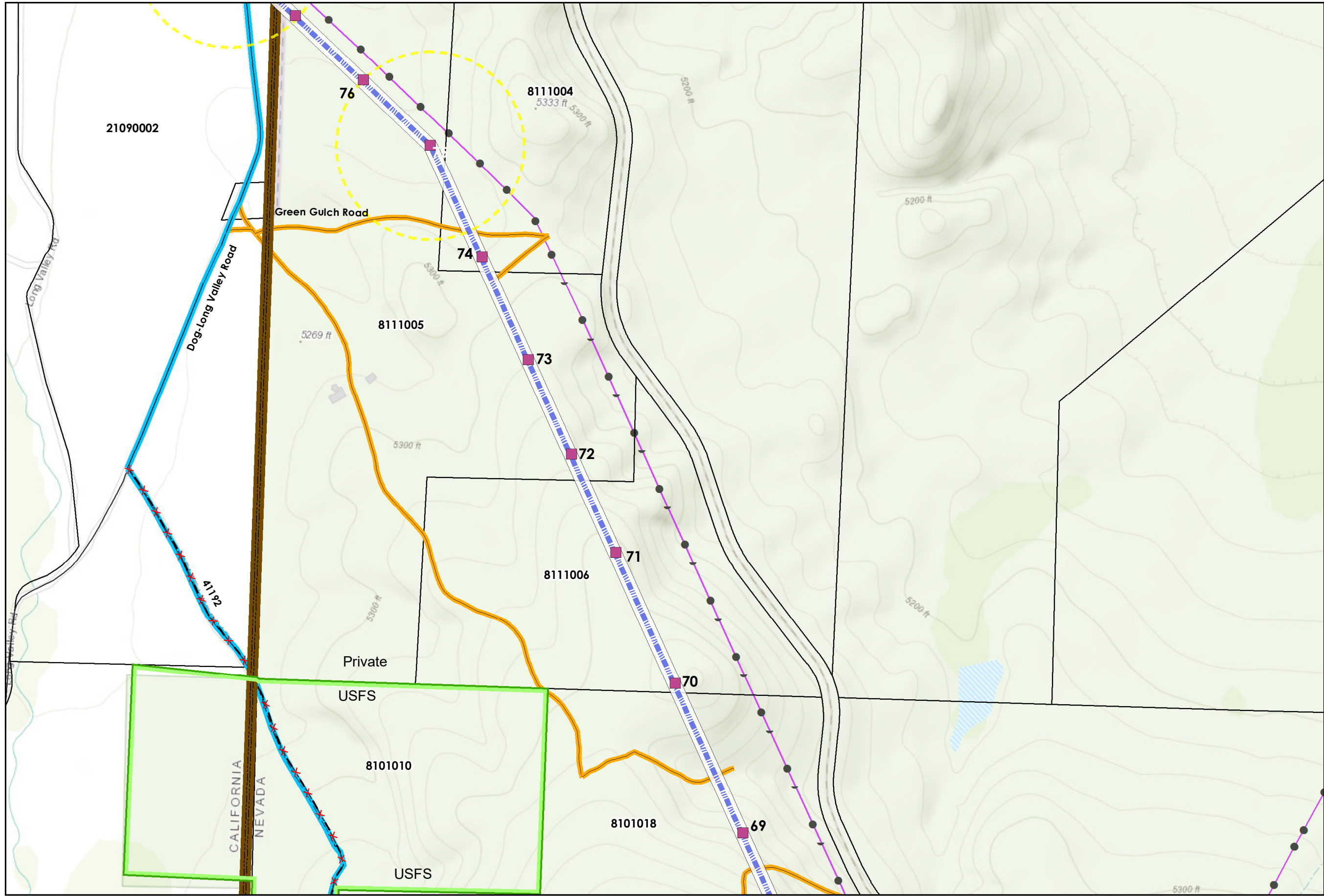

Bordertown to California 120 kV Transmission Line Project Construction and Access Mapbook

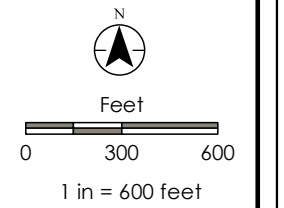

Sierra County, CA &
Washoe County, NV
NAD 1983 UTM Zone 11N

PROJECT NO: 203703160
DRAWN BY: CJ
1ST REVIEW: JT
2ND REVIEW: KC
DATE: 5/11/2020

2
OF 11 SHEETS

V:\2037\Active\203703160\03_data\vgb_cad\gis\mxd\Map_Books\Construction_and_Access_Mapbook\Construction_Access_Mapbook_Topo_11x17L.mxd Revised: 2020-01-22 By: chphinson

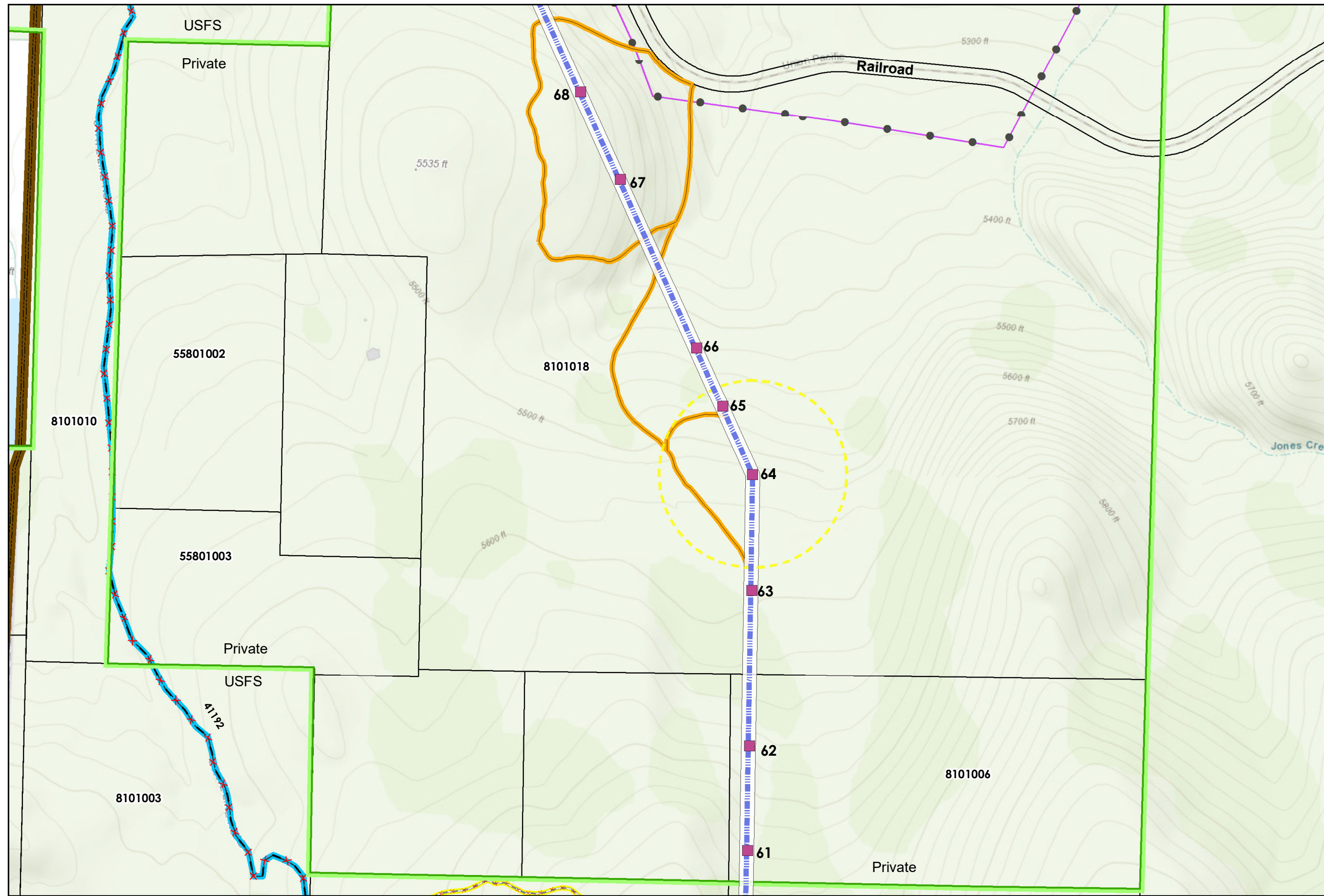

**Bordertown to California 120 kV
Transmission Line Project
Construction and Access Mapbook**

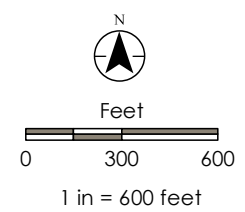

Sierra County, CA &
Washoe County, NV
NAD 1983 UTM Zone 11N

PROJECT NO: 203703160
DRAWN BY: CJ
1ST REVIEW: JT
2ND REVIEW: KC
DATE: 1/22/2020

3
OF 11 SHEETS

V:\2023\Active\203703160\03_data\gls_cad\gis\mxd\Map_Books\Construction_and_Access_Mapbook\Construction_Access_Mapbook_Topo_11x17L.mxd Revised: 2020-01-22 By: chiphinson

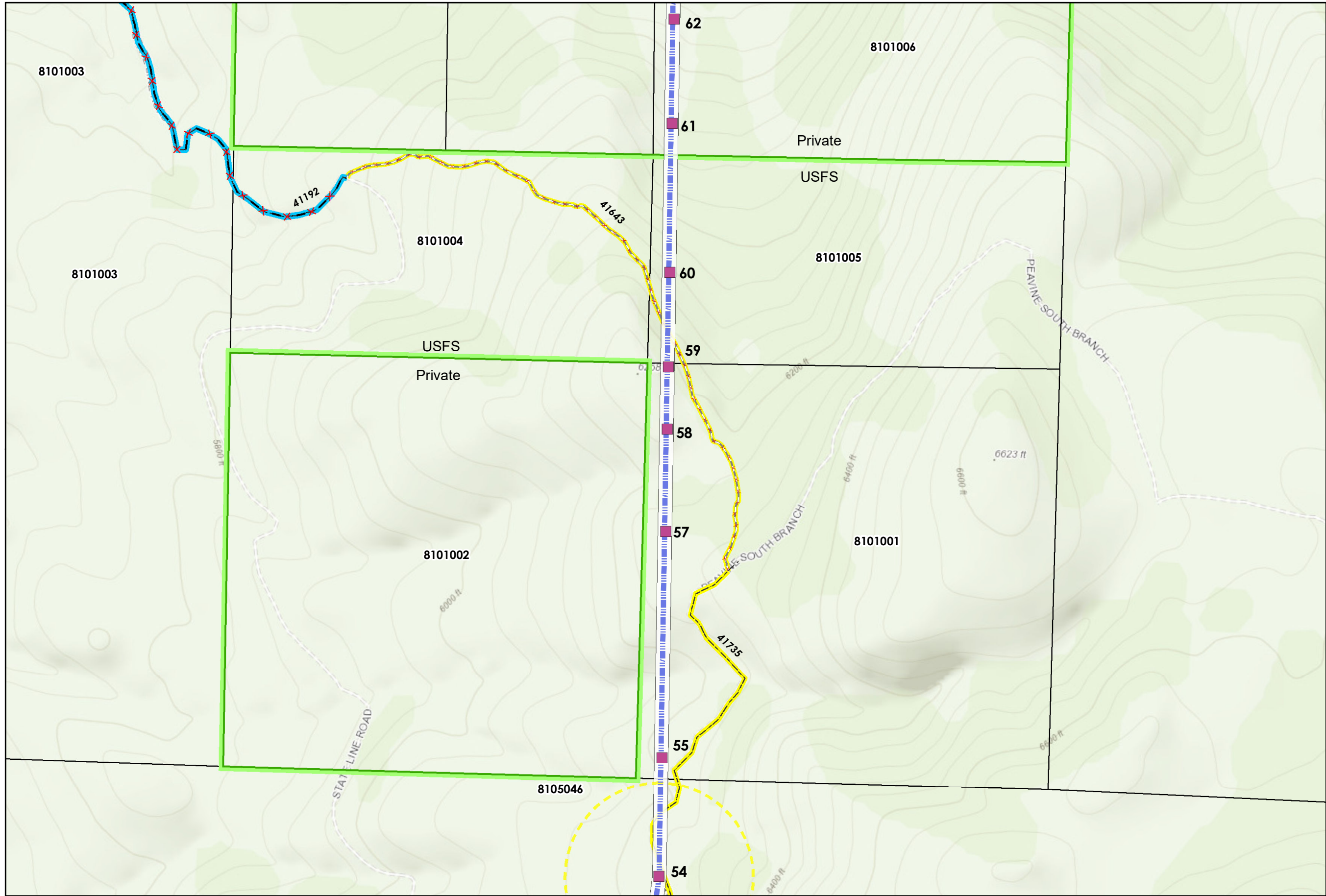

**Bordertown to California 120 kV
Transmission Line Project
Construction and Access Mapbook**

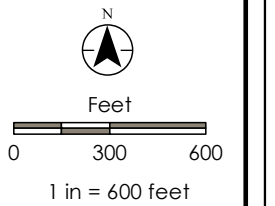

Sierra County, CA &
Washoe County, NV
NAD 1983 UTM Zone 11N

PROJECT NO: 203703160
DRAWN BY: CJ
1ST REVIEW: JT
2ND REVIEW: KC
DATE: 1/22/2020

4
OF 11 SHEETS

V:\2037\Active\203703160\03_data\gls_cad\gls\mxd\Map_Books\Construction_and_Access_Mapbook\Construction_Access_Mapbook_Topo_11x17L.mxd Revised: 2020-01-22 By: chiphinson

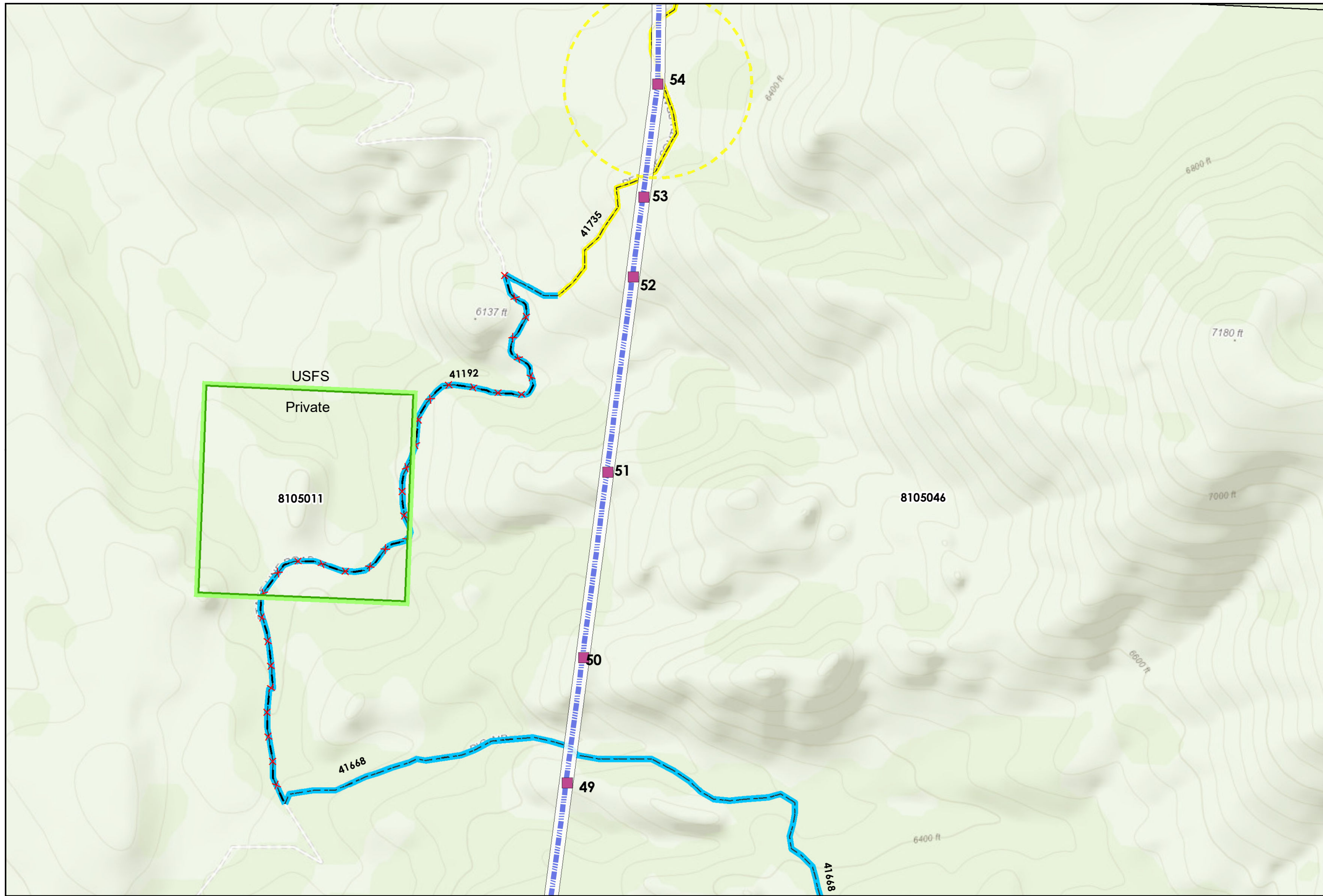

**Bordertown to California 120 kV
Transmission Line Project
Construction and Access Mapbook**

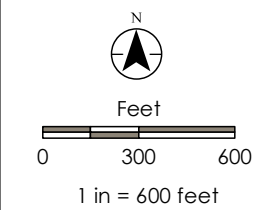

Sierra County, CA &
Washoe County, NV
NAD 1983 UTM Zone 11N

PROJECT NO: 203703160
DRAWN BY: CJ
1ST REVIEW: JT
2ND REVIEW: KC
DATE: 1/22/2020

5
OF 11 SHEETS

V:\2037\Active\203703160\03_data\gls_cad\gls\mxd\Map_Books\Construction_and_Access_Mapbook\Construction_Access_Mapbook_Topo_11x17L.mxd Revised: 2020-01-22 By: chphinson

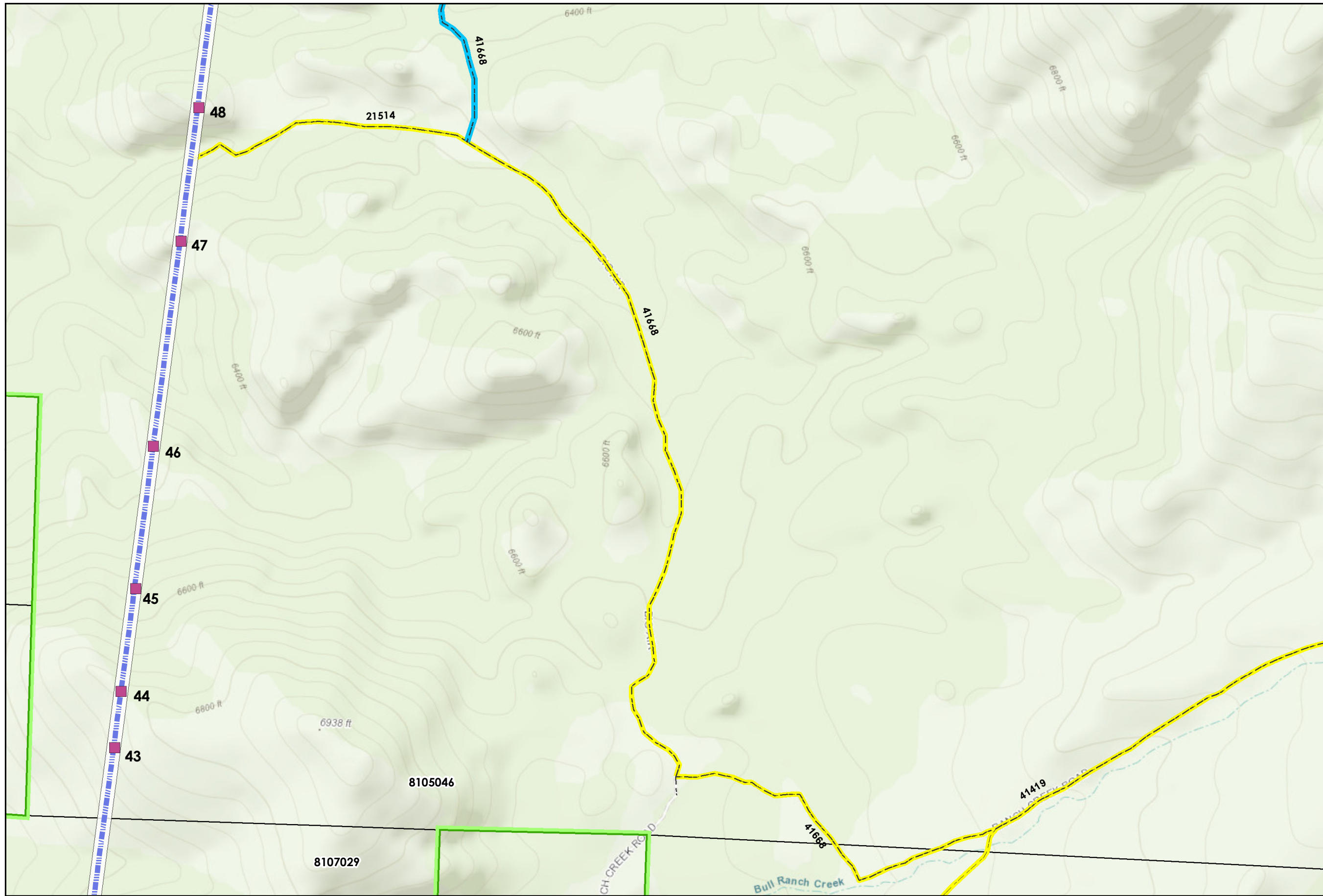

**Bordertown to California 120 kV
Transmission Line Project
Construction and Access Mapbook**

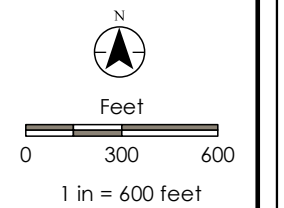

Sierra County, CA &
Washoe County, NV
NAD 1983 UTM Zone 11N

PROJECT NO: 203703160
DRAWN BY: CJ
1ST REVIEW: JT
2ND REVIEW: KC
DATE: 1/22/2020

6
OF 11 SHEETS

V:\2037\Active\203703160\03_data\gls_cad\gis\mxd\Map_Books\Construction_and_Access_Mapbook\Construction_Access_Mapbook_Topo_11x17L.mxd Revised: 2020-01-22 By: chiphinson

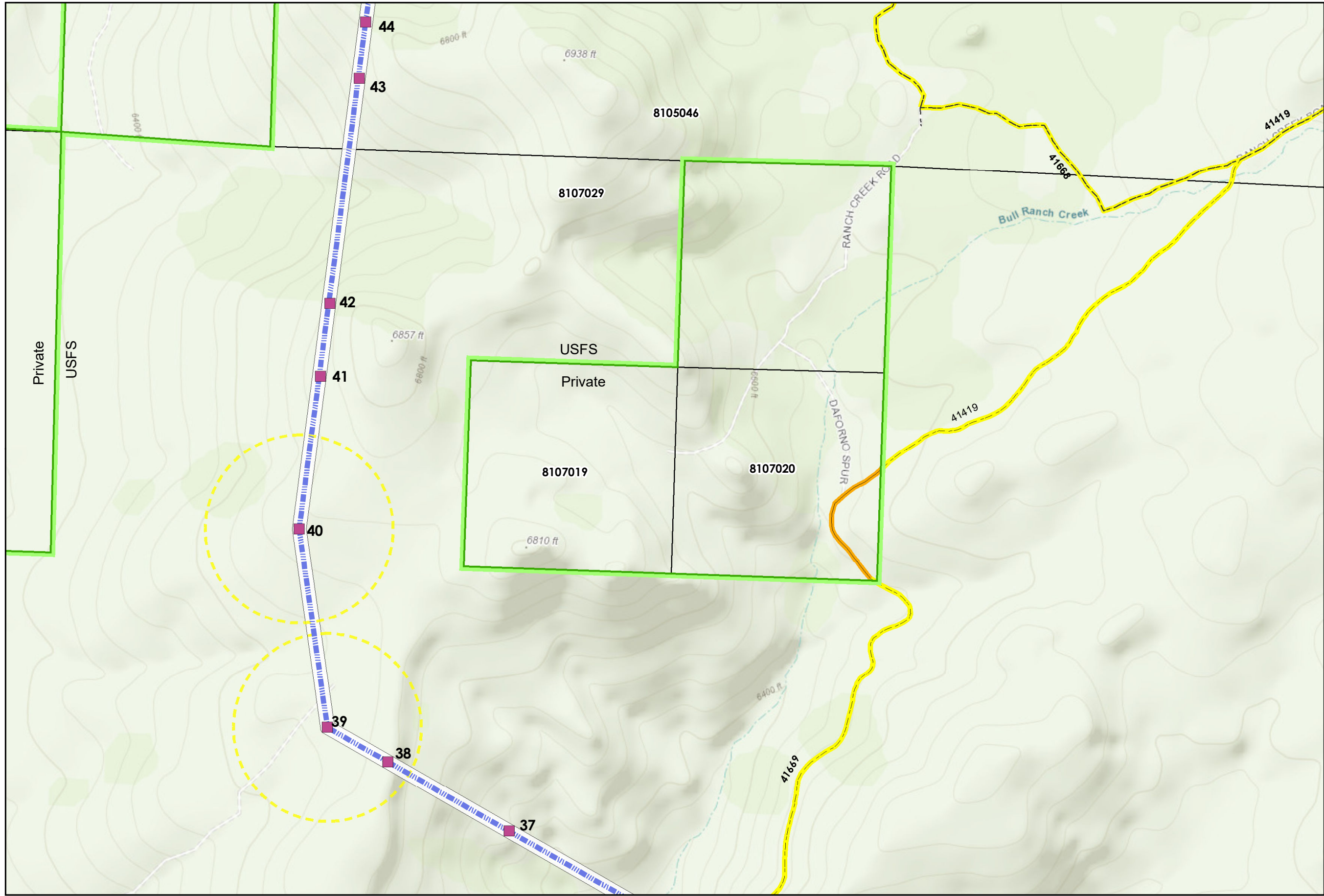

**Bordertown to California 120 kV
Transmission Line Project
Construction and Access Mapbook**

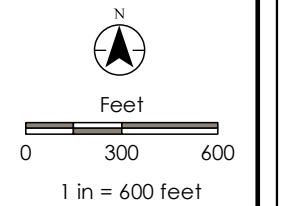

Sierra County, CA &
Washoe County, NV
NAD 1983 UTM Zone 11N

PROJECT NO: 203703160
DRAWN BY: CJ
1ST REVIEW: JT
2ND REVIEW: KC
DATE: 1/22/2020

7
OF 11 SHEETS

V:\2023\Active\203703160\03_dtda\gls_cad\gls\mxd\Map_Books\Construction_and_Access_Mapbook\Construction_Access_Mapbook_Topo_11x17L.mxd Revised: 2020-01-22 By: chiphinson

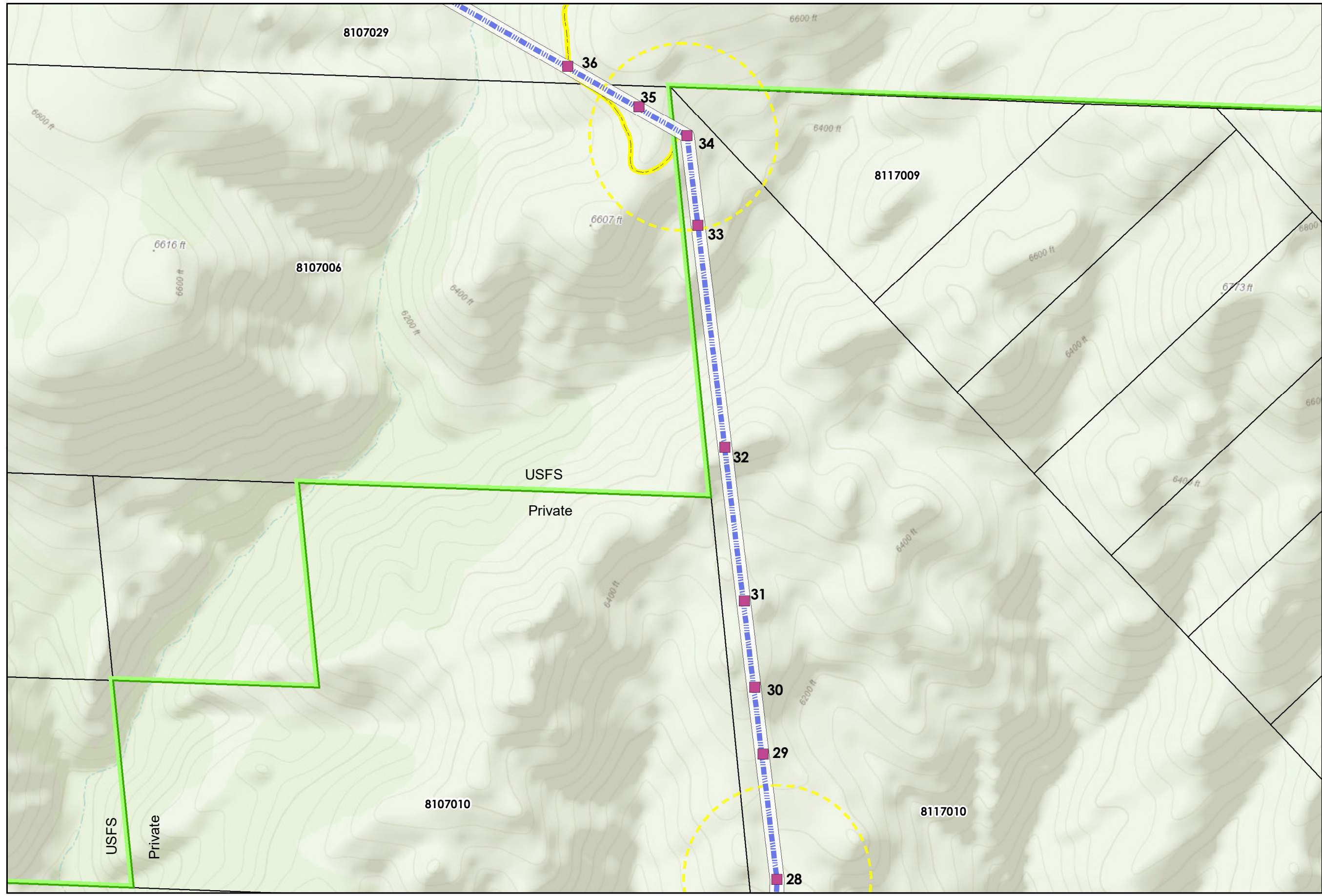

Bordertown to California 120 kV Transmission Line Project Construction and Access Mapbook

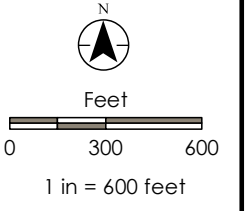

Sierra County, CA &
Washoe County, NV
NAD 1983 UTM Zone 11N

PROJECT NO: 203703160
DRAWN BY: CJ
1ST REVIEW: JT
2ND REVIEW: KC
DATE: 1/22/2020

Disclaimer: Stantec assumes no responsibility for data supplied in electronic format. The recipient accepts full responsibility for verifying the accuracy and completeness of the data. The recipient releases Stantec, its officers, employees, consultants and agents, from any and all claims arising in any way from the content or provision of the data.

Service Layer Credits: Sources: Esri, HERE, Garmin, Intermap, increment P Corp., GBBCO, USGS, FAO, NPS, NRCAN, Geobase, IGN, Kadaster NL, Ordnance Survey, Esri Japan, METI, Esri China (Hong Kong), Swisstopo, Mapbox Contributors, and the GIS User Community

V:\2023\Active\203703160\03_data\gls_cad\gis\mxd\Map_Books\Construction_and_Access_Mapbook\Construction_Access_Mapbook_Topo_11x17L.mxd Revised: 2020-01-22 By: chphinson

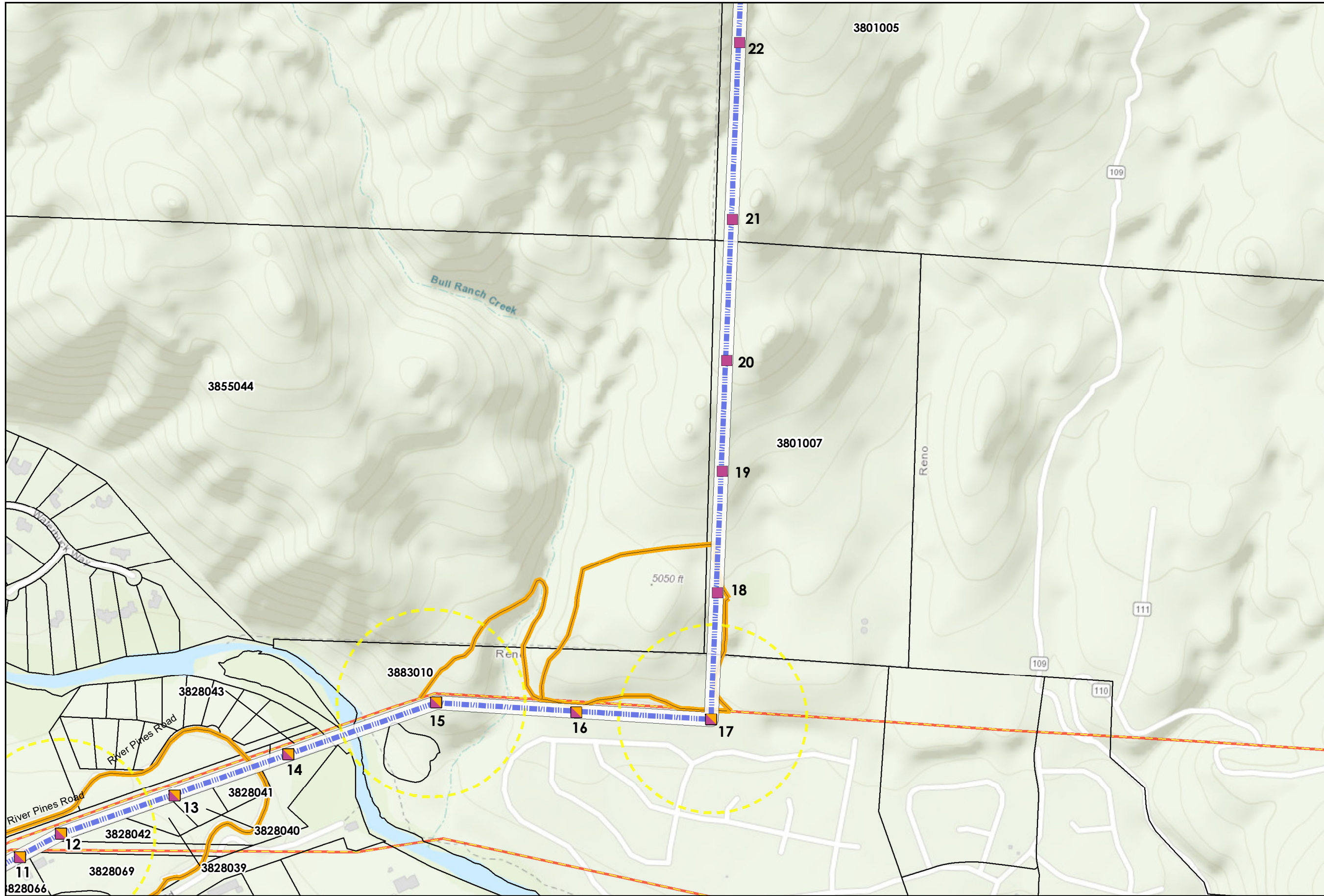

Bordertown to California 120 kV Transmission Line Project Construction and Access Mapbook

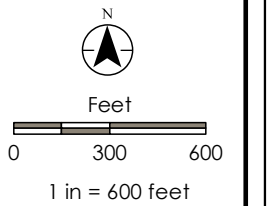

Sierra County, CA &
Washoe County, NV
NAD 1983 UTM Zone 11N

PROJECT NO: 203703160
DRAWN BY: CJ
1ST REVIEW: JT
2ND REVIEW: KC
DATE: 1/22/2020

10
OF 11 SHEETS

V:\2023\Active\203703160\03_data\gls_cad\gis\mxd\Map_Books\Construction_and_Access_Mapbook\Construction_Access_Mapbook_Topo_11x17.mxd Revised: 2020-01-22 By: chiphinson

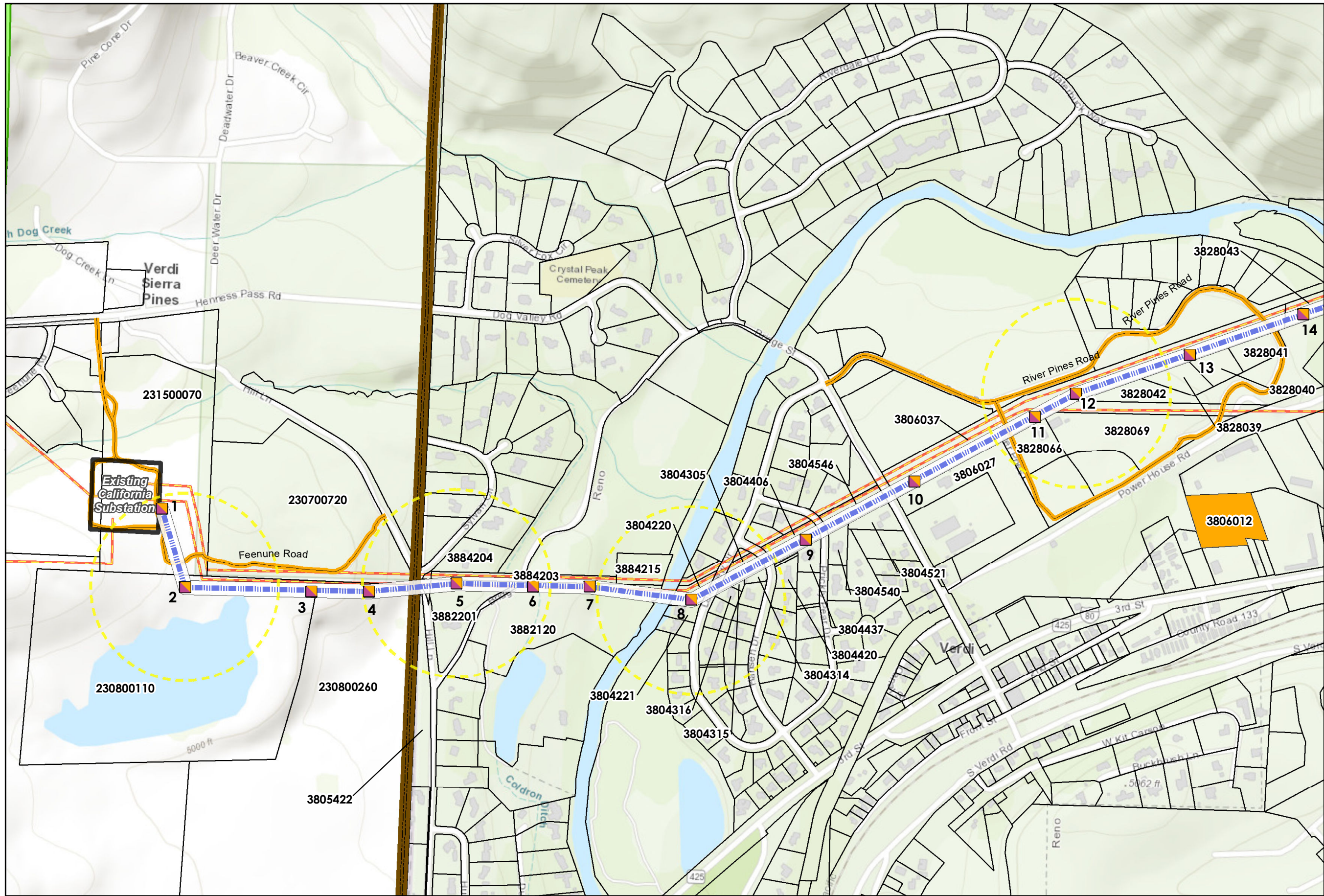

Bordertown to California 120 kV Transmission Line Project Construction and Access Mapbook

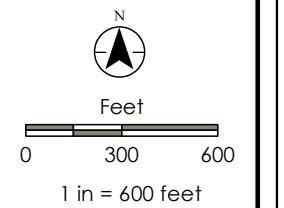

Sierra County, CA &
Washoe County, NV
NAD 1983 UTM Zone 11N

PROJECT NO: 203703160
DRAWN BY: CJ
1ST REVIEW: JT
2ND REVIEW: KC
DATE: 1/22/2020

11
OF 11 SHEETS

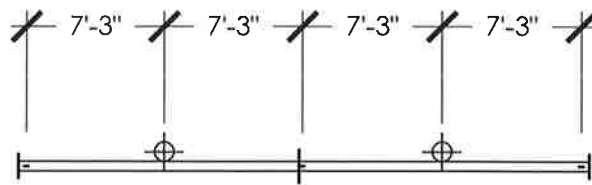

TOP VIEW

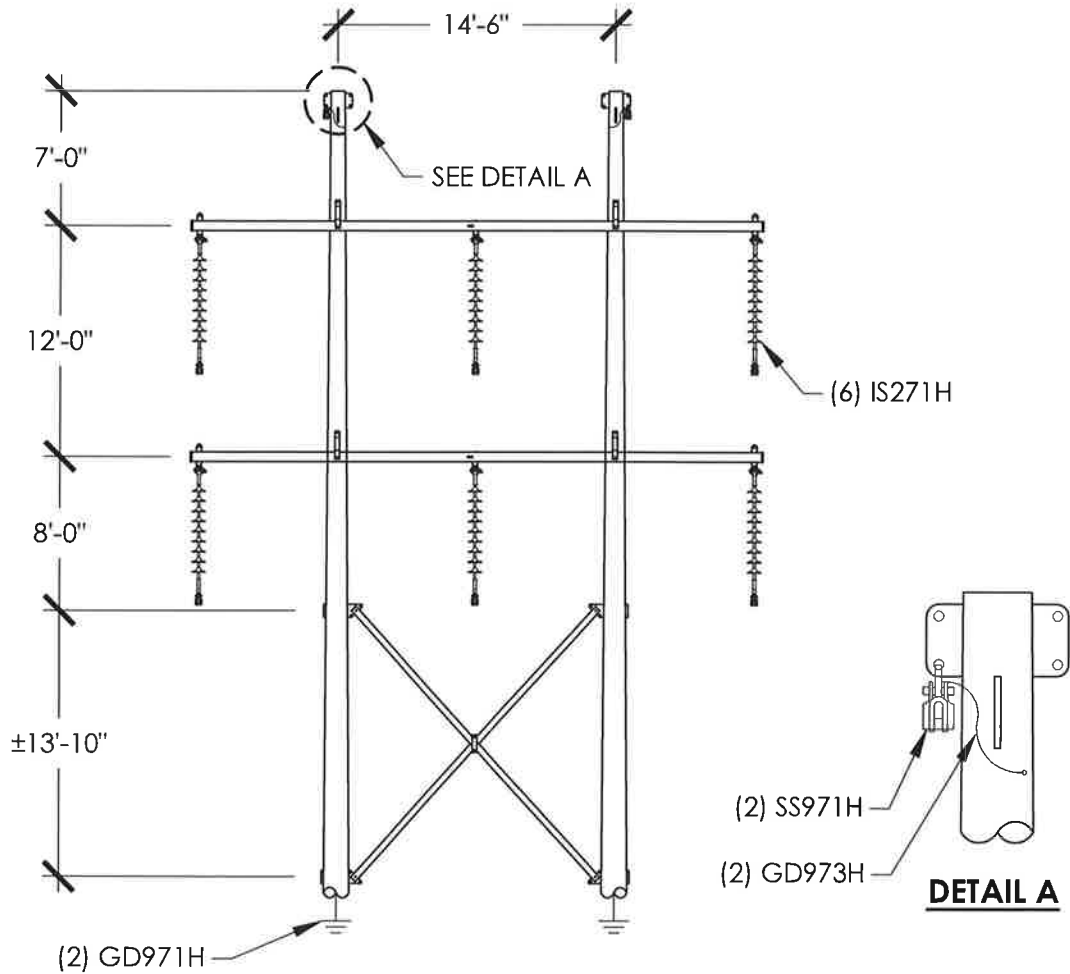

FRONT ELEVATION

NOTES

1. REFERENCE MANUFACTURER DRAWINGS FOR STRUCTURE DETAILS

STRUCTURE LIST

6, 8, 9, 10



1104 LINE: CALIFORNIA TO BORDERTOWN
**DOUBLE-CIRCUIT H-FRAME TANGENT
 w/ STATIC WIRE, 14'-6" POLE SPACING
 STEEL POLE, POLYMER**

PID: TL446V7BCS

DT276H

DRAWN:	ENG:	APPR:	DATE:
CBT	CBT	---	04/2023

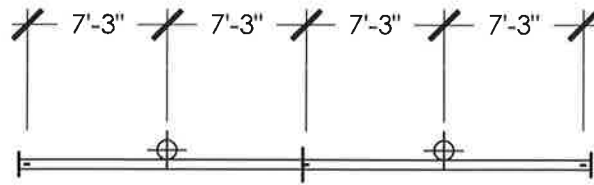

TOP VIEW

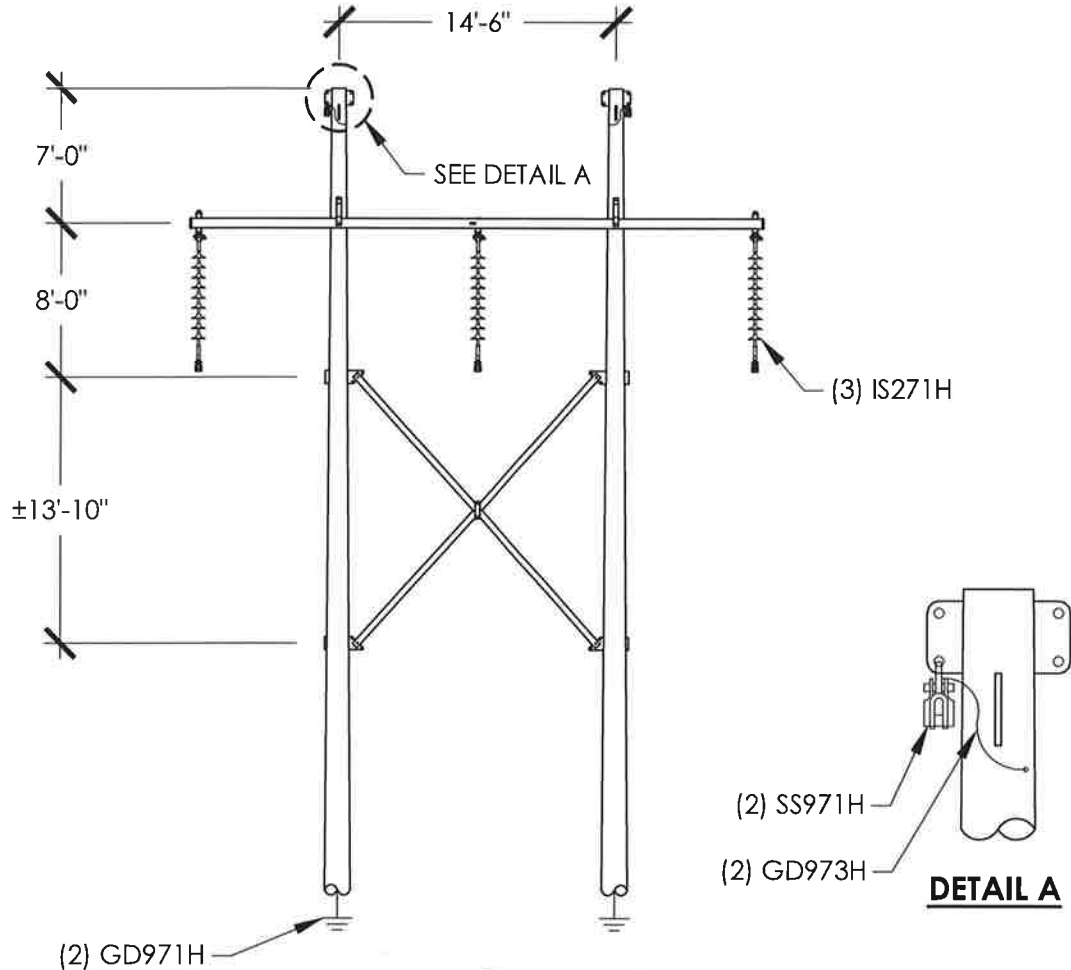

FRONT ELEVATION

NOTES

- 1. REFERENCE MANUFACTURER DRAWINGS FOR STRUCTURE DETAILS

STRUCTURE LIST

3, 12, 15, 17-19,
21, 22, 26-29,
35-37, 40-43,
47-49, 51



1104 LINE: CALIFORNIA TO BORDERTOWN

PID: TL446V7BCS

**H-FRAME TANGENT
w/ STATIC WIRE, 14'-6" POLE SPACING
STEEL POLE, POLYMER**

DT274H

DRAWN:	ENG:	APPR:	DATE:
CBT	CBT	---	04/2023

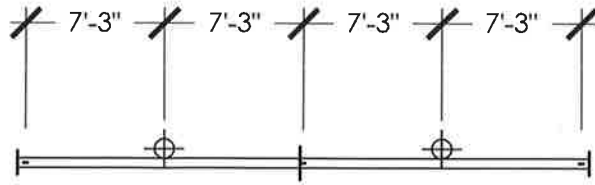

TOP VIEW

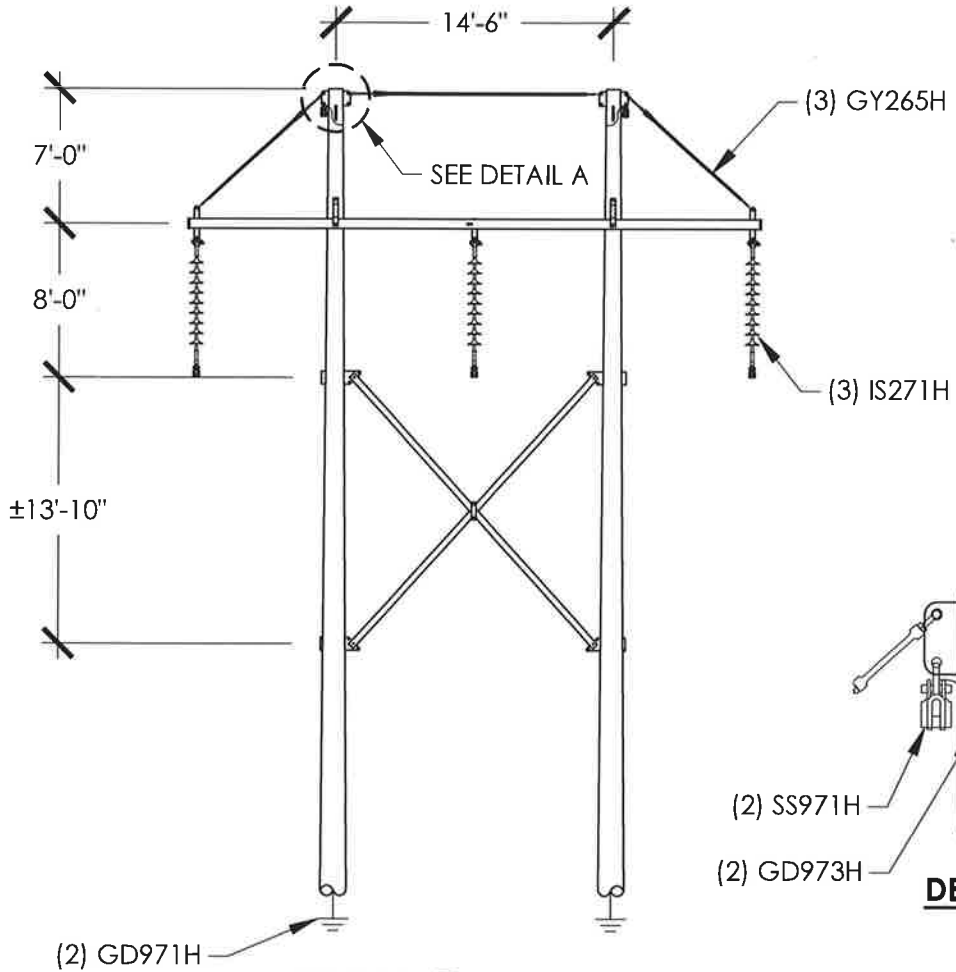

FRONT ELEVATION

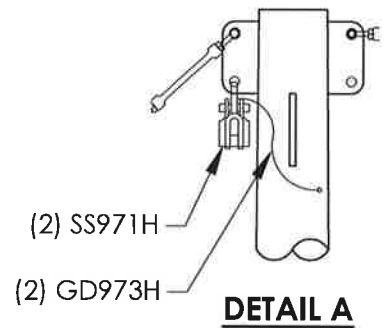

DETAIL A

NOTES

- 1. REFERENCE MANUFACTURER DRAWINGS FOR STRUCTURE DETAILS

STRUCTURE LIST

20, 23, 24, 38, 44, 45, 50



1104 LINE: CALIFORNIA TO BORDERTOWN

PID: TL446V7BCS

**HEAVY LOADING H-FRAME TANGENT
w/ STATIC WIRE, 14'-6" POLE SPACING
STEEL POLE, POLYMER**

**DT274H
HEAVY**

DRAWN:	ENG:	APPR:	DATE:
CBT	CBT	--	04/2023

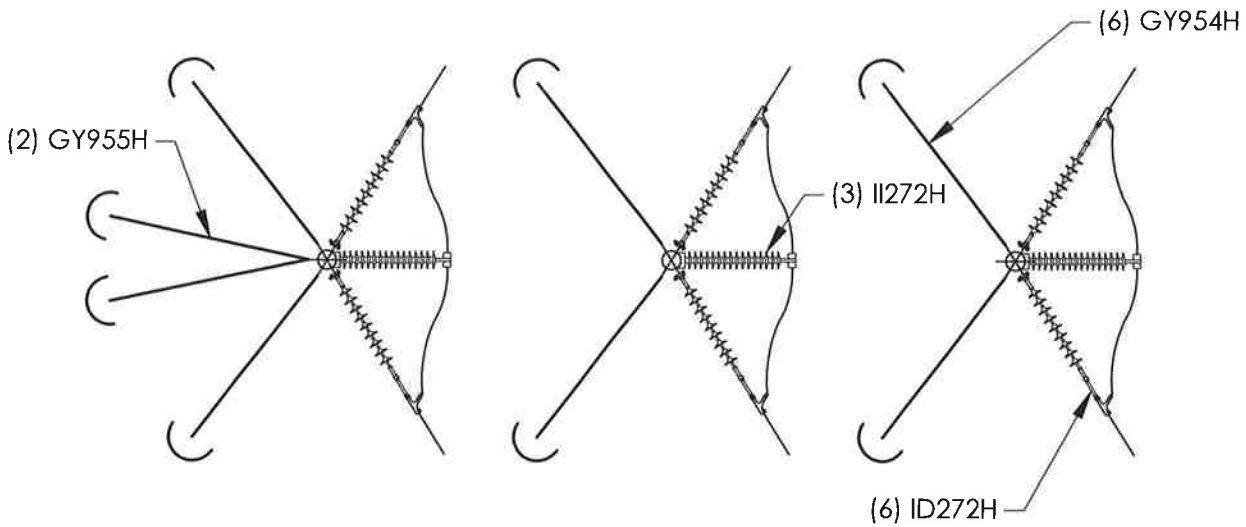

TOP VIEW

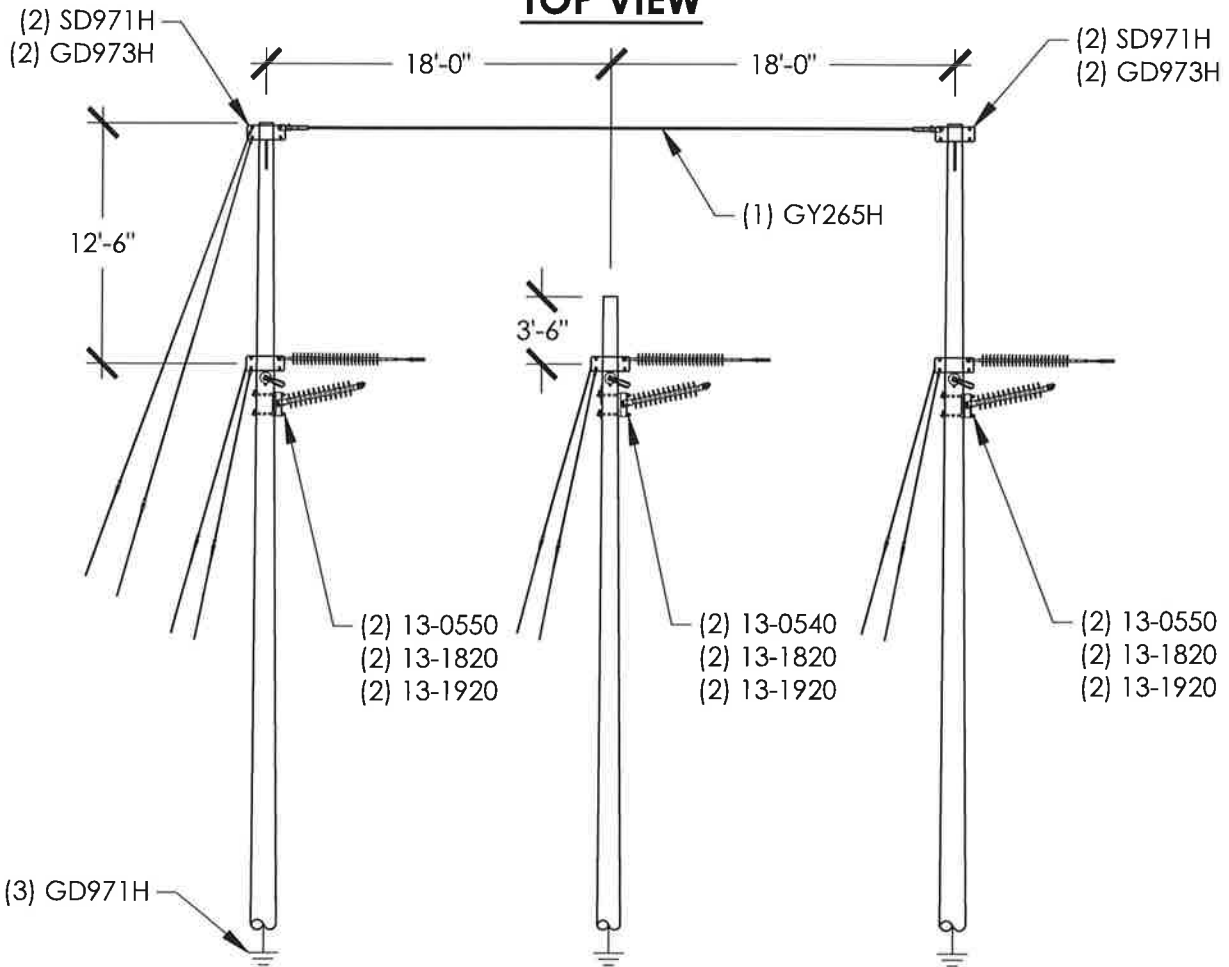

FRONT ELEVATION

NOTES

1. REFERENCE MANUFACTURER DRAWINGS FOR STRUCTURE DETAILS

STRUCTURE LIST

4, 14, 25, 33, 34, 46



1104 LINE: CALIFORNIA TO BORDERTOWN

PID: TL446V7BCS

**3 POLE DEADEND ANGLE
w/ STATIC WIRE DEADEND
STEEL POLE, POLYMER**

HA274H

DRAWN:	ENG:	APPR:	DATE:
CBT	CBT	---	04/2023

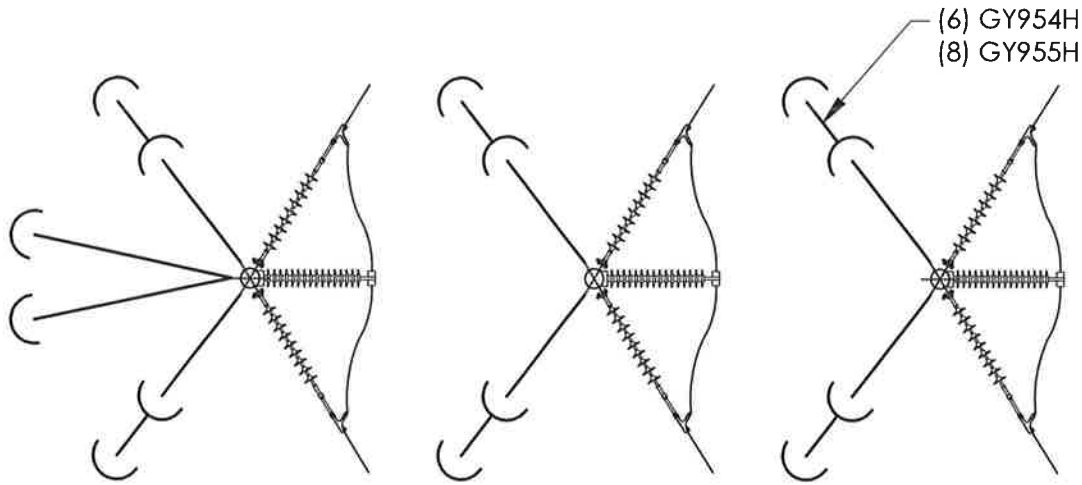

TOP VIEW

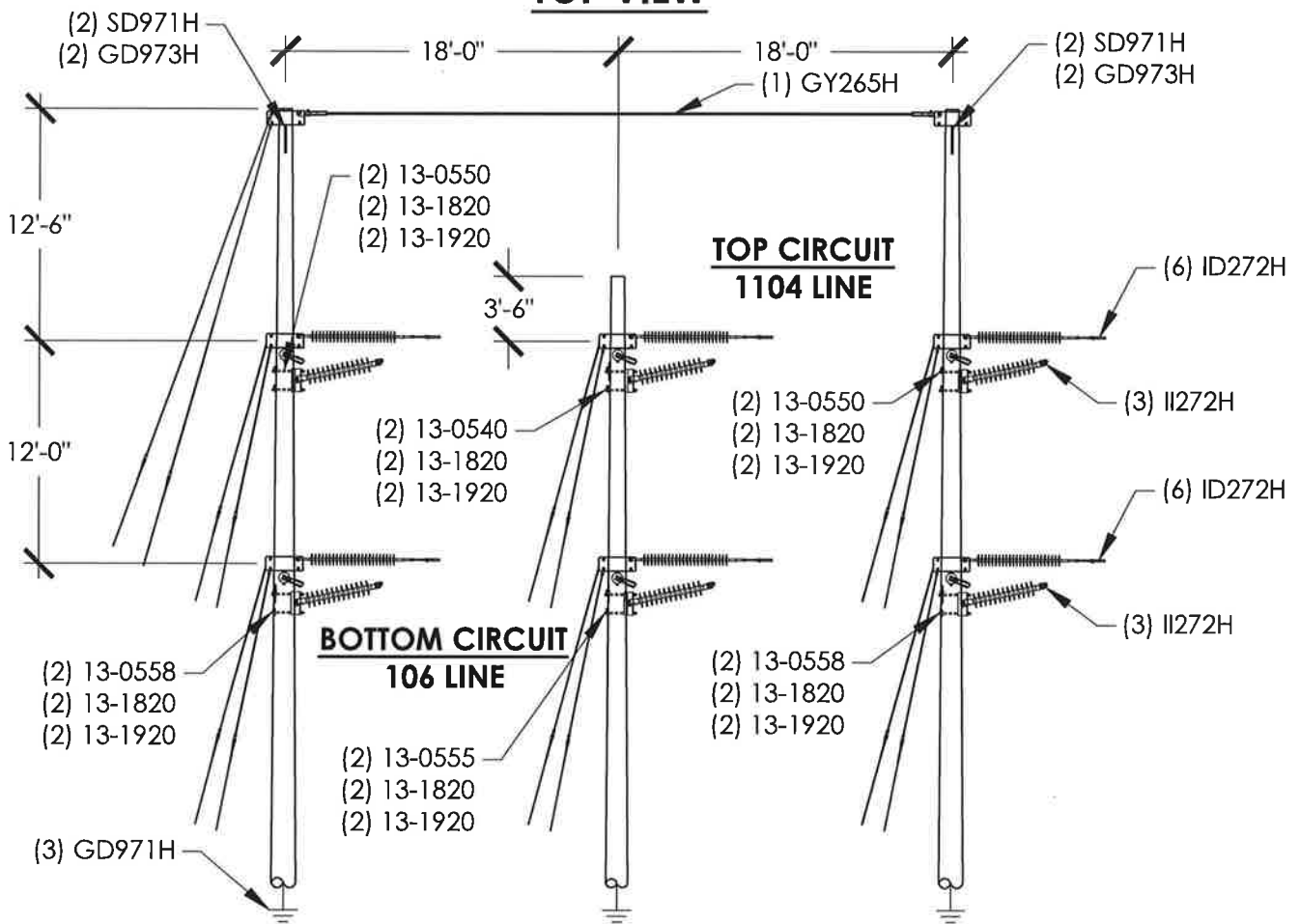

NOTES

1. REFERENCE MANUFACTURER DRAWINGS FOR STRUCTURE DETAILS

FRONT ELEVATION

STRUCTURE LIST

8, 11



**1104 LINE: CALIFORNIA TO BORDERTOWN
DOUBLE CIRCUIT 3-POLE ANGLE
w/ STATIC WIRE DEADEND
STEEL POLE, POLYMER**

PID: TL446V7BCS

HA276H

DRAWN:	ENG:	APPR:	DATE:
CBT	CBT	---	04/2023

TAB C



**Bordertown to California
120 kV Transmission Line Project
Construction, Operation, and Maintenance (COM) Plan**

Prepared for:

NV Energy
6100 Neil Road
Reno, Nevada 89511

Prepared by:

Stantec Consulting Services Inc.
6995 Sierra Center Parkway
Reno, Nevada 89511

August 2020

Table of Contents

KEY CONTACTS LIST	VI
1.0 INTRODUCTION.....	1
1.1 COM Plan Purpose and Need.....	1
1.2 COM Plan Components	1
2.0 MANAGEMENT	3
2.1 Roles and Responsibilities	3
2.1.1 NV Energy.....	3
2.1.2 United States Forest Service (USFS)	3
2.1.3 Bureau of Land Management (BLM).....	3
2.1.4 Construction Contractors.....	3
2.2 Permits and Approvals.....	3
2.3 Communications and Notification Protocol	5
3.0 PROJECT OVERVIEW AND FACILITIES	5
3.1 Project Facilities.....	5
3.1.1 Transmission Line	5
3.1.2 Substation Facilities	6
3.1.3 Roads.....	6
3.2 Project Design Features.....	7
3.2.1 General Practices (GP)	7
3.2.2 Noxious Weeds (NW).....	8
3.2.3 Vegetation (VG).....	9
3.2.4 Herbicide Use (HE)	10
3.2.5 Forest Health (FH) - Insects and Disease.....	11
3.2.6 Water Resources and Soil (WA).....	12
3.2.7 Plants and Sensitive Plant Communities (SV)	13
3.2.8 Wildlife and Sensitive Wildlife Species (WL).....	14
3.2.9 Cultural Resources (CU)	16
3.2.10 Hazardous Materials and Waste (HM).....	17
3.2.11 Recreation/Roads/Transportation (RT).....	17
3.2.12 Visual Resources (VI).....	18
3.2.13 Fire Prevention and Response (FP)	18
3.2.14 Air Quality (AQ).....	18
4.0 CONSTRUCTION ACTIVITIES	19
4.1 Construction Schedule.....	19
4.2 Land and Environmental Surveying	19
4.2.1 Pre-Construction Surveys and Staking	19
4.3 Substation Construction.....	20
4.3.1 Site Preparation.....	20
4.3.2 Structural and Electrical Construction	20
4.4 Transmission Line Construction	21
4.4.1 Existing Access Roads	21
4.4.2 New Access Roads	21
4.4.3 Stream Crossings.....	22
4.4.4 ROW/Easement Preparation	22



4.4.5	Power Pole Structures.....	22
4.4.6	ROW/Easement Restoration and Reclamation.....	25
4.5	Fences and Gates.....	25
4.6	Staging Areas.....	25
4.7	Health and Safety.....	25
4.8	Accident Reporting.....	26
4.9	Environmental Compliance Program.....	26
4.9.1	Roles and Responsibilities.....	26
4.9.2	Compliance Levels and Reporting.....	27
4.9.3	Project Changes.....	31
4.9.4	Communications.....	33
4.9.5	Environmental Training Program.....	33
4.10	Construction Workforce and Equipment.....	33
4.11	Waste Disposal.....	34
4.12	Cleanup and Restoration.....	34
4.12.1	ROW Cleanup.....	34
4.12.2	Access Road and Centerline Travel Route Reclamation.....	34
5.0	OPERATION AND MAINTENANCE ACTIVITIES.....	35
5.1	Standard Operating Procedures.....	35
5.2	New or Reconstruction Activities and Standards.....	35
5.3	Maintenance Activities and Standards.....	35
5.4	Right-of-Way Operations.....	36
5.5	Emergency Procedures.....	36
6.0	TERMINATIONS AND ABANDONMENT OF RIGHT-OF-WAY.....	37
7.0	REFERENCES.....	38

List of Figures

Figure 1	General Location
Figure 2	Project Alignment-Overview
Figure 3	Bordertown Substation Modification
Figure 4	California Substation Modification
Figure 5	Tree-Trimming and Clearance Distances
Figure 6	Single Pole Structure
Figure 7	H-Frame Structure
Figure 8	3-Pole Dead-end/Angle Structure

List of Tables

Table 2-1	Applicable Permits/Approvals that Might be Needed.....	4
Table 3-1	Permanent ROW/Easement Requirements.....	6
Table 3-2	Road Widening.....	7
Table 3-3	Minimum Buffers (ft) for Herbicide Application Near Aquatic Features.....	11
Table 4-1	Pre-Construction Surveys Status.....	19
Table 4-2	NV Energy Environmental Compliance Team.....	26
Table 4-3	Notification Form.....	28
Table 4-4	Non-Compliance Report.....	29



Table 4-5	Non-Compliance Resolution Report.....	30
Table 4-6	Examples of Major and/or Minor Changes	31
Table 4-7	Change Evaluation Form	32

List of Appendices

A. Health and Safety

- A1 Fire Prevention and Suppression Plan
- A2 Hazardous Materials Management and Spill Prevention Plan
- A3 Emergency Preparedness and Response Plan
- A4 Blasting Plan

B. Logistics

- B1 Transportation Management Plan
- B2 Flagging and Fencing Plan

C. Environmental Resources

- C1 Noxious Species Abatement Plan
- C2 Streams, Wetlands, Wells, and Springs Protection Plan
- C3 Reclamation and Habitat Restoration Plan
- C4 Wildlife Protection Plan
- C5 Storm Water Pollution Prevention Plans *(to be completed when Construction Contractor is onboard)*

D. Historic Resources

- D1 Inadvertent Discovery Plan

E. Permits (to be added when obtained)



Maps (Bound Separately)

Volume I Centerline Construction and Access Maps

Volume II Environmental Field Maps

LIST OF ABBREVIATIONS

AQ	Air Quality
ATV	All-Terrain Vehicle
BLM	Bureau of Land Management
BMPs	Best Management Practices
CE	Change Evaluation
CFR	Code of Federal Regulations
COM	Construction, Operation, And Maintenance
CPUC	California Public Utilities Commission
CU	Cultural Resources
dbh	Diameter at Breast Height
EIS	Environmental Impact Statement
FH	Forest Health
FP	Fire Prevention and Response
GP	General Practices
HE	Herbicide Use
HM	Hazardous Materials and Waste
kV	Kilovolt
MOA	Memorandum of Agreement
NAC	Nevada Administrative Code
NCR	Non-Compliance Report
NCRR	Non-Compliance Resolution Report
NDOW	Nevada Department of Wildlife
NEPA	National Environmental Policy Act
NESC	National Electric Safety Code
NFS	National Forest System
NPDES	National Pollutant Discharge Elimination System
NRS	Nevada Revised Statutes
NW	Noxious Weeds
PAC	Protected Activity Center
Project	Bordertown to California 120 Kilovolt Transmission Line Project
ROD	Record of Decision
ROW	Right-of-Way
RT	Recreation/Roads/Transportation
SHPO	State Historic Preservation Office
SIP	Single Inspection Program
SPCC	Spill Prevention, Control, And Countermeasure Plan



SUP	Special Use Permit
SV	Plants and Sensitive Plant Communities
SWPPP	Storm Water Pollution Prevention Plan
U.S.	United States
USFS	United States Forest Service
VG	Vegetation
VI	Visual Resources
WA	Water Resources and Soil
WL	Wildlife and Sensitive Wildlife Species



KEY CONTACTS LIST

(This list will be updated by NV Energy and the Construction Contractor as needed during construction, operation and maintenance).

NV Energy

P.O. Box 10100, 6100 Neil Road, Reno, Nevada 89520-0024

Laura Clifford, PMP
Associate Project Manager
Phone: (775) 834-4361
Fax: (775) 834-4659
lclifford@nvenergy.com

Lee Simpkins
Environmental Supervisor
Phone: (775) 834-3528
Fax: (775) 834-3158
lsimpkins@nvenergy.com

Terry Saunders
Construction Manager
Phone: (775) 834-4616
Fax: (775) 834-3996
tsaunders@nvenergy.com

Cory Tague
Senior Engineer
Phone: (775) 834-3913
Fax: (775) 834-4659
ctague@NVEnergy.com

Nate Hastings
Right-of-Way Agent
Phone: (775) 834-4510
Fax: (775) 834-4189
nhastings@nvenergy.com

Doug Larson
Surveying & Mapping
Phone: (775) 834-4650
Fax: (775) 834-4189
dlarson@nvenergy.com

NV Energy – Prime Construction Contractor

TBD

NV Energy – Single Inspection Program (SIP) Team

Stantec- Ben Veach (main contact)
Phone: (775) 398-1257
Cell: (775) 750-3583
ben.veach@stantec.com

NV Energy – Quality Assurance Team

TBD

Emergency Contacts

Call 911 for emergency assistance.

County Sheriffs

Washoe County Sheriff's Office
(775) 328-3001

Sierra County Sheriff's Office
(530) 289-3700

Fire - Call 911 First.

Sierra Front Interagency Dispatch

(775) 883-3535 for Emergencies
(775) 883-5995 for Administration

USFS Humboldt-Toiyabe National Forest Carson Ranger District

(775) 882-2766
Supervisor's Office
(775) 331-6444

BLM

Eagle Lake Field Office
(530) 257-0456

Poison Control

(800) 222-1222



Hospitals

Saint Mary's Regional Medical Center
235 West 6th Street
Reno, Nevada 89503
(775) 770-3000

Renown Regional Medical Center
1155 Mill Street
Reno, Nevada 89502
(775) 982-4100

Hazardous Spill Response and Notification

Directly after 911 notification, the following mandatory notifications will be made by NV Energy's Environmental Manager or Field Supervisor. Select and notify the appropriate government agency(ies) based on the geographic location of the spill site. See Appendix A2 - Hazardous Materials Management and Spill Prevention Plan.

Call 911 First.

If after hours and the spill is located in Nevada, call the Nevada Highway Patrol Dispatch at:
(775) 687-5300.

National Response Center:
(800) 424-8802

Nevada Division of Environmental Protection:
(775) 687-9485

Sierra County, California Office of Emergency Services:
(530) 289-2850

If after hours and the spill is located in California, call the California Highway Patrol Dispatch at:
1-800-835-5247

Nevada Office of Emergency Management:
(775) 687-0400

California Governor's Office of Emergency Services State Warning Center:
(800) 852-7550

Washoe County, Nevada Risk Management Division:
(775) 328-2665

Environment Consultant (for EIS and COM Plan)

Greg Brown

Project Manager
Stantec Consulting Services Inc.
3995 South 700 East, Suite 300
Salt Lake City, UT 84107
Phone: (801) 438-2256
Greg.brown2@stantec.com

Steve Morton

Deputy Project Manager
Stantec Consulting Services Inc.
6995 Sierra Center Parkway
Reno, NV 89511
Phone: (775) 398-1244
Steve.morton@stantec.com

Wildlife, Wetlands, and Plant Resource Specialists

Steve Morton

Wetland Resource Specialist
Stantec Consulting Services Inc.
6995 Sierra Center Parkway
Reno, NV 89511
Phone: (775) 398-1244
Steve.morton@stantec.com

Western Botanical Services
Plant Resource Specialist
5859 Mt. Rose Highway
Reno, NV 89511
Phone: (775) 849-3223

Josh Vittori

Wildlife and Plant Resource Specialist
Stantec Consulting Services Inc.
6995 Sierra Center Parkway
Reno, NV 89511
Phone: (775) 398-1259
Josh.vittori@stantec.com

Erica Freese

Wildlife and Plant Resource Specialist
Stantec Consulting Services Inc.
6995 Sierra Center Parkway
Reno, NV 89511
Phone: (775) 398-1232
Erica.freese@stantec.com



Cultural Resource Specialists

Vickie Clay – Principal Investigator
vickie@farwestern.com
Far Western Anthropological Research Group, Inc.
3656 Research Way, Suite 32
Carson City, NV 89706
Phone: (775) 847-0223

Albert Garner – Senior Archaeologist
albert@farwestern.com
Far Western Anthropological Research Group, Inc.
3656 Research Way, Suite 32
Carson City, NV 89706
Phone: (775) 847-0223

Geotechnical Consultant

TBD

Surveying & Mapping Consultant

TBD

Agencies

United States Forest Service - Humboldt-Toiyabe National Forest

Marnie Bonesteel
Special Use Administrator/ COM Plan
Project Manager
1200 Franklin Way
Sparks, NV 89431
Office Phone: (775) 352-1240
Cell: 775-221-9225
marniebonesteel@usda.gov

Kalie Crews
District Archaeologist
1536 S. Carson Street
Carson City, NV 89701
Phone: (775) 884-8108
kalie.crews@usda.gov

Bureau of Land Management – Eagle Lake Field Office

Dan Ryan
Realty Specialist
2550 Riverside Drive
Susanville, CA 96130
Phone: (530) 252-5321
Fax: (530) 257-5312
dryan@blm.gov

State Historic Preservation Office

Rebecca Palmer
State Historic Preservation Officer
100 N. Stewart Street Capitol Complex
Carson City, Nevada 89701
Phone: (775) 684-3448
Fax: (775) 684-3442
rlpalmer@shpo.nv.gov



Nevada Department of Wildlife

Mark Freese
Western Region Habitat Supervisor
1100 Valley Road
Reno, Nevada 89512
Phone: (775) 688-1506
Fax: (775) 688-1595
markfreese@ndow.org

Other

TBD



1.0 INTRODUCTION

NV Energy has prepared this plan to guide the construction, operation, and maintenance of the Bordertown to California 120 Kilovolt (kV) Transmission Line Project (Project). The 11.9-mile line will provide a connection between the Bordertown Substation north of Reno, Nevada to the California Substation located near Verdi, Nevada (**Figure 1**). The purpose of the Project is to provide a backup power line that will continue to serve the west side of Reno in the event that the existing power lines currently serving the area have an outage or other system interruption. Installing a power line between the Bordertown and California substations will allow NV Energy to provide the power needed to meet reliability requirements of their electrical system.

Approximately 10.8 miles of the transmission line will be constructed in Nevada and 1.1 miles in California. Approximately 4.3 miles of the transmission line will cross National Forest System (NFS) land, 0.4 mile will cross Bureau of Land Management (BLM) land, and 7.2 miles will cross private land (**Figure 2**). The Bordertown Substation will be expanded by approximately 3.7 acres on BLM land. The California Substation will not be expanded, as all needed modifications will be within the existing fenced area of the substation located on private land.

As the Project will cross NFS lands, an Environmental Impact Statement (EIS) was prepared to analyze the Project's environmental effects and identify appropriate mitigation measures, pursuant to the National Environmental Policy Act (NEPA). The United States (U.S.) Forest Service (USFS) served as the lead agency, in cooperation with the BLM Eagle Lake Field Office, Nevada Department of Wildlife (NDOW), Truckee Meadows Regional Planning Agency, Washoe County, Sierra County and the City of Reno. As lead agency, the USFS maintains the primary oversight responsibility to ensure that the EIS mitigation measures are carried out (USFS 2018 and 2019).

1.1 COM PLAN PURPOSE AND NEED

The purpose of this Construction, Operation, and Maintenance (COM) Plan is to present a clear set of guidelines and maps that describes to the transmission line contractor(s) how to successfully plan and build the Project. The COM Plan informs NV Energy and the construction contractor(s) personnel on the environmental requirements for constructing, operating, and maintaining the Project, in compliance with the Final Record of Decision (ROD), the USFS Special Use Permit (SUP), and other applicable permits (USFS 2019). It focuses on appropriate implementation of required environmental compliance measures and other related actions.

1.2 COM PLAN COMPONENTS

COM Plan

The COM Plan contains a general Project overview, followed by a discussion of the roles and responsibilities of NV Energy and the USFS, including communications, environmental monitoring, and reporting procedures. It also describes construction activities such as surveying and staking, transmission tower installation, line stringing, access roads, and substation expansion activities. Health and safety, emergency preparedness, training programs and workforce information are also discussed in the main body of the document. The following plans provide more detailed information on specific topics and are included as appendices to this volume:



Appendices

A. Health and Safety

- A1 Fire Prevention and Suppression Plan
- A2 Hazardous Materials Management and Spill Prevention Plan
- A3 Emergency Preparedness and Response Plan
- A4 Blasting Plan

B. Logistics

- B1 Transportation Management Plan
- B2 Flagging and Fencing Plan

C. Environmental Resources

- C1 Noxious Weed Species Plan
- C2 Streams, Wetlands, Wells, and Springs Protection Plan
- C3 Reclamation and Habitat Restoration Plan
- C4 Wildlife Protection Plan
- C5 Storm Water Pollution Prevention Plans

D. Historic Resources

- D1 Inadvertent Discovery Plan

The following volumes are bound separately but are essential parts of the COM Plan. They contain detailed maps and information that outline the location of the transmission line and associated Project components, protection of sensitive resources, and reclamation activities. The maps show locations of sensitive resources and identify design features, best management practices (BMPs) and construction details that correspond to the protection of those resources. The volumes are designed to be used together in the field by NV Energy, its construction contractor(s), and the environmental compliance team.

Volume I – Centerline Construction and Access Road Maps

These maps will be used to identify Project facilities along the Project centerline, including structure locations, pulling and staging areas, and private parcel information, including land status. These maps also show details for approved roads used to access the construction right-of-way (ROW). NV Energy, its contractor(s), and USFS will use these maps in conjunction with the Environmental Field Maps contained in Volume II, as tools to support the implementation of the design features and environmental commitments contained in this COM Plan.

Volume II – Environmental Field Maps

The environmental field maps will support the Centerline Construction and Access Road Maps by providing additional and more detailed information on resources in the areas, sensitive areas, seasonal restrictions, limited works areas, etc. based upon the design features approved for the Project.



2.0 MANAGEMENT

2.1 ROLES AND RESPONSIBILITIES

This section covers the roles and responsibilities of specific management and field staff personnel during construction, operation, and maintenance phases of the Project.

2.1.1 NV Energy

As the applicant and owner of the transmission line, NV Energy has the responsibility to construct, operate, and maintain the Project in compliance with all federal, state, and local regulations, and in accordance with NEPA, the EIS, the ROD, the USFS SUP, the BLM ROW Grant, and other applicable permits. NV Energy is responsible to oversee and manage the construction contractor(s) to make sure they comply with conditions contained within this COM Plan.

2.1.2 United States Forest Service (USFS)

In their role as Lead Agency, USFS has the oversight responsibility to ensure that this COM Plan includes the commitments required of NV Energy and their contractor(s) in accordance with NEPA, the EIS and ROD, and USFS SUP. The USFS a SUP for the use of a transmission line ROW. Temporary roads and construction access located outside of the transmission line ROW are authorized by a temporary SUP. The COM Plan includes USFS' and responsible parties' contact information, as well as a written process whereby the USFS will work and communicate with NV Energy compliance inspectors.

2.1.3 Bureau of Land Management (BLM)

The BLM has oversight responsibility on lands they manage, which is the land around the Bordertown Substation. The expansion of the Bordertown Substation is authorized by an amendment to NV Energy's existing ROW Grant.

2.1.4 Construction Contractors

One or more construction contractors may be contracted by NV Energy to construct the transmission line and the modifications to the existing substations. All of these contractors will need to be familiar with the conditions of the COM Plan. Contractor(s) will be legally bound to the requirements of the COM Plan through conditions included in bid documents. Specific information about contractor(s), their management, and staff will be incorporated in the COM Plan before the start of construction. The contractor(s) must comply with all permit requirements regarding the environment and compliance with environmental regulations will be a condition of the contract with NV Energy.

2.2 PERMITS AND APPROVALS

In addition to the USFS SUP, NV Energy has other federal, state, and local permits and approvals necessary for construction. The additional approvals contain specific conditions and requirements that are incorporated into the COM Plan. Applicable permits are listed in Table 2-1.



Table 2-1 Applicable Permits/Approvals that Might be Needed

Action	Permit/ Approval (if applicable)	Approving Agency
<p><i>Dredge or fill activities in Waters of the U.S. (i.e., construction of a road crossing for channels that drain to the Truckee River)</i></p> <p><i>Note: At this time, a 404 Permit is not anticipated to be needed.</i></p>	<p><i>Clean Water Act, Section 404 Permit, Nationwide Permit 12</i></p>	<p><i>U.S. Army Corps of Engineers</i></p>
<p><i>Facilities construction</i></p>	<p><i>Construction Permit</i></p>	<p><i>Nevada Division of Environmental Protection, Bureau of Air Pollution Control</i></p>
<p><i>Facilities construction</i></p>	<p><i>Clean Water Act, Section 402 National Pollutant Discharge Elimination System (NPDES) Notification for Stormwater Management during Construction</i></p>	<p><i>Nevada Division of Environmental Protection, Bureau of Water Pollution Control</i></p>
<p><i>Facilities construction</i></p>	<p><i>Clean Water Act, Section 402 NPDES Notification for General Permit for Discharges of Storm Water Associated with Construction Activity</i></p>	<p><i>Lahontan Regional Water Quality Control Board</i></p>
<p><i>Construction or operation of facilities (i.e., road crossings) resulting in discharge into Waters of the U.S.</i></p>	<p><i>Clean Water Act, Section 401 Water Quality Certification</i></p>	<p><i>Nevada Division of Environmental Protection, Bureau of Water Quality Planning</i></p>
<p><i>Tree removal and vegetation management activities</i></p>	<p><i>R6T-2009-0029 Timber Waiver</i></p>	<p><i>Lahontan Regional Water Quality Control Board</i></p>
<p><i>Tree removal in California</i></p>	<p><i>Public Agency, Public and Private Utility Right of Way Exemption (waives requirement to prepare a Timber Harvest Plan)</i></p>	<p><i>California Department of Forestry and Fire Protection</i></p>
<p><i>Surface disturbing activities in Nevada</i></p>	<p><i>Surface Area Disturbance Permit and Dust Control Permit; Waste Discharge Permit; Working in Waterways Permit</i></p>	<p><i>Nevada Division of Environmental Protection, Bureau of Air Pollution Control and Bureau of Water Pollution Control</i></p>
<p><i>Aerial crossing over the Truckee River</i></p>	<p><i>Easement</i></p>	<p><i>Nevada Division of State Lands</i></p>
<p><i>ROW/Land Use/Facilities Construction in California</i></p>	<p><i>Encroachment Permit/SUP</i></p>	<p><i>Sierra County Planning Commission</i></p>

Action	Permit/ Approval (if applicable)	Approving Agency
<i>ROW/Easement in Washoe County outside of City of Reno</i>	<i>SUP</i>	<i>Washoe County Board of Adjustment or Planning Commission</i>
<i>ROW/Easement in Washoe County</i>	<i>Plan Amendment</i>	<i>Truckee Meadows Regional Planning Agency</i>
<i>Facilities Construction, Grading, and/or Hillside Development</i>	<i>SUP(s)</i>	<i>City of Reno Planning Commission</i>
<i>ROW/Easement within City of Reno</i>	<i>SUP</i>	<i>City of Reno Planning Commission</i>

Source: USFS 2018

2.3 COMMUNICATIONS AND NOTIFICATION PROTOCOL

A communication and notification process is intended to keep NV Energy, their contractor(s), the USFS, BLM, and the public well informed of activities during construction. NV Energy will have primary responsibility for communicating with agency personnel regarding compliance with Project conditions and periodic agency compliance inspections. NV Energy will also have the primary responsibility for notifying property owners of upcoming construction activities and ensuring that construction contractor(s) are trained on how to interact with property owners and other members of the public during construction.

Additional details regarding emergency notification of agencies (e.g., in case of wildfire, spills, discovery of a burial site, or other unforeseen circumstances) are presented in various resource-specific plans attached as appendices to the COM Plan. The Key Contacts List is included as part of this COM Plan and will be updated by NV Energy as needed throughout the Project.

3.0 PROJECT OVERVIEW AND FACILITIES

The primary components of the Project include:

- Construction, operation, and maintenance of a 120-kV overhead transmission line;
- Expansion of the Bordertown Substation facility;
- Improvements within the California Substation facility;
- Widening existing roads for access;
- Construction of new temporary access roads; and
- Restoration of construction-related disturbance.

3.1 PROJECT FACILITIES

3.1.1 Transmission Line

The 120-kV transmission line will consist of three aluminum composite core conductors, one fiber optic shield wire cable, and one steel shield wire cable supported on single circuit pole structures. A combination of single-pole structures, two-pole H-frame structures, and three-pole dead end/angle structures will be used. Single-pole structures will be used less frequently where confined space prevents the use of two-pole H-frame or three-pole dead end/angle structures, which are



wider than the single-pole structures. The ROW/easement width will be reduced from 90 feet to 40 feet in constrained areas where single pole structures are used. The span distance between the poles will average 800 feet but could range from 200 feet to 2,000 feet depending on terrain or obstructions.

The transmission line is approximately 11.9 miles long. From the Bordertown Substation, it heads southwest, paralleling the west side of the Alturas 345-kV transmission line (**Figure 2**). It then generally parallels the California and Nevada state line, staying on the Nevada side by approximately 0.6 to 0.9 miles east of the state line for approximately 6 miles. The line then jogs another approximately 0.7 miles to the east, approximately 1.5 miles from the state line which it parallels for another 3 miles before turning due west.

The last approximately 2 miles will replace the existing H-frame pole structures of the inactive 60 kV #632 distribution line in its existing location, and parallel to the existing #114 and #106 lines through Verdi to the California Substation. A total of approximately 4.4 miles of transmission line route will be located within an existing power line corridor. **Table 3-1** summarizes the land status and length of ROW/easement in California and Nevada.

Table 3-1 Permanent ROW/Easement Requirements

Land Ownership	Miles in California	Miles in Nevada	Total Miles	Percent of Total	Acres of ROW/Easement ¹
<i>USFS</i>	<i>0</i>	<i>4.3</i>	<i>4.3</i>	<i>36.4</i>	<i>46.9</i>
<i>BLM</i>	<i>0.4</i>	<i>0.0</i>	<i>0.4</i>	<i>3.3</i>	<i>8.1</i>
<i>Private Land</i>	<i>0.7</i>	<i>6.5</i>	<i>7.2</i>	<i>60.2</i>	<i>78.5</i>
<i>Total</i>	<i>1.1</i>	<i>10.8</i>	<i>11.9</i>	<i>100</i>	<i>133.5</i>

¹ Includes proposed expansion area associated with the Bordertown Substation. In addition, requests from private landowners could result in revisions on private land.

3.1.2 Substation Facilities

The Bordertown Substation will be partially rebuilt and modified with the addition of new components in order to accommodate connection of the new transmission line. The Bordertown Substation will be expanded by 3.7 acres on BLM-administered public land. Proposed modifications to the Bordertown Substation will include vegetation clearing and grading; and expansion of the existing chain-link fence for security and to restrict unauthorized persons and wildlife from entering. The site will be graded to near level and surfaced with gravel. Noxious weeds will be treated and monitored to prevent spreading onto adjacent land.

The California Substation is located on private land owned by NV Energy. All needed modifications to accommodate connection of the new transmission line will be constructed within the existing fenced area of the substation. The footprint of the existing substation will not be expanded.

3.1.3 Roads

3.1.3.1 Existing Roads

Existing roads will be used for construction and maintenance access as much as possible; however, some existing roads will be widened up to 30 feet, including cut and fill slopes to accommodate construction equipment. Approximately 15.4 miles of existing roads will need to be widened for



construction access. The acres of surface disturbance associated with widening are presented in **Table 3-2**.

Table 3-2 Road Widening

Road/Route Type	Widening Required (Miles)	Surface Disturbance (Acres) ¹
<i>Designated NFS Roads on NFS Land</i>	4.4	10.7
Non-Designated Routes on NFS Land	0.7	1.7
<i>Existing Roads Across Private Land</i>	10.3	24.9
<i>Total (Roads/Routes on All Land)</i>	15.4	37.3

¹ Does not include existing road disturbance, which is assumed to be 9 feet wide.

3.1.3.2 New Temporary Access Roads

New temporary access roads (i.e., centerline travel road and spur roads) will be constructed to pole sites, transmission wire setup sites, and staging areas when there are no existing roads available. Access roads will be up to 30 feet wide and located within the 300- to 600-foot-wide corridor (variable-width corridor). The variable-width corridor will be centered on the transmission line and will measure 300 feet wide where slopes are 10 percent or less, and 600 feet wide where slopes are greater than 10 percent. Approximately 7.8 miles of new temporary centerline travel roads will be used for overland travel.

3.2 PROJECT DESIGN FEATURES

NV Energy has committed to the following Project Design Features to be implemented during construction, operation, and maintenance of the Project as part of the EIS ROD for the Project. The following Project Design Features are applicable to the selected alternative and the approved Project.

3.2.1 General Practices (GP)

- GP 1. All environmentally sensitive areas (i.e., culturally sensitive areas, meadows, and special status plant populations) will be temporarily fenced during construction for avoidance.
- GP 2. Prior to construction, all construction personnel will be instructed on the protection of sensitive biological and cultural resources that have the potential to occur on-site by qualified personnel.
- GP 3. Construction activities may require temporary access through existing fences and gates on public and private land. Fencing will be replaced when construction activities are completed. Replacement fencing will be built to agency or landowner specifications, consistent with the fencing that was removed. During construction, fences with open gates will remain open and fences with closed gates will remain closed. Fences crossed during construction will be braced and secured prior to cutting the fence to prevent slackening of the wire.
- GP 4. If blasting is required within proximity to the Kinder Morgan buried gas pipeline located next to Dog Valley/Henness Pass Road between Verdi and “Summit One”, NV Energy will coordinate with Kinder Morgan and use a qualified licensed blaster.



- GP 5. Concrete wash out stations will be pre-approved and the water will be captured and disposed off of NFS lands and at an approved facility.
- GP 6. Long-term equipment staging and storage areas will not be located on NFS land.
- GP 7. Near sensitive receptors (i.e., occupied residences), noise-generating activities (e.g., blasting) will be limited to Monday through Friday from 7:00 a.m. to 7:00 p.m. Otherwise, work may occur 12 hours per day any day of the week.
- GP 8. Annual inspection will be made via helicopter or from the ground by walking to pole structures from existing roads.
- GP 9. Signs, flagging, or other readily visible markings will be used to indicate the presence of guy wires to reduce the potential for people and wildlife to run into the wires.

3.2.2 Noxious Weeds (NW)

- NW 1. Noxious weeds occurring on either the Nevada or California State list will be mapped and the full extent of the population will be treated prior to and following construction. Inventory and treatment areas will extend 100 feet from the ROW/easement and all ground disturbed by Project activities. Project disturbances include roads proposed for widening, construction access roads, equipment and material staging areas, and vegetation removal, including skid trails and landings.
- NW 2. Monitoring and continued treatment in areas that were treated prior to construction will commence the first full growing season after Project implementation. Weed treatment will continue until disturbed areas are successfully restored (see restoration criteria). Weed treatment will continue during maintenance activities and within the ROW/easement.
- NW 3. All equipment utilized off of existing roads and motorized trails will be cleaned with a high-pressure power washer of all mud, dirt, and plant parts. Following cleaning, equipment will be inspected for plant parts (e.g., leaves, stems, seeds). Equipment will be cleaned and inspected again prior to re-entry if it leaves the Project site. Equipment will be inspected and cleaned again before moving from an area within the Project area with known noxious weed species. Inspections will be completed and documented by qualified personnel such as a USFS noxious weed specialist or USFS botanist.
- NW 4. When cut and fill is required to create log landings, topsoil will be stockpiled and covered to prevent weeds from establishing in the soil. This topsoil will be re-spread during restoration of the landings.
- NW 5. Staging areas and fly yards will not be located in weed infested areas. Staging areas will be inspected by qualified personnel for pre-approved use to reduce the risk of introducing noxious weeds into the Project area.
- NW 6. Construction of access roads will not occur in areas heavily infested with noxious or invasive weeds.
- NW 7. Restoration seed mixes will be certified as weed-free.
- NW 8. All gravel and/or fill material will be certified as weed-free.

- NW 9. NV Energy will coordinate with other county, state and federal agencies to address and treat landscape level infestations of invasive plant species.
- NW 10. For invasive plants that can be effectively controlled through grubbing or manual removal, methods that prevent seed spread or re-sprouting will be used. If flowers or seeds are present, the weed will be pulled carefully to prevent seeds from falling and will be placed in an appropriate container for disposal. If flowers and seedheads are not present or are removed and disposed of as described above, the invasive plant may be pulled and placed on the ground to dry out.
- NW 11. The appropriate method of control specific to the type of noxious weed will be used. Specific methods will be identified in a specific Noxious Weed Species Plan (Appendix C1).

3.2.3 Vegetation (VG)

- VG 1. Placement of the ROW/easement will avoid wherever possible, isolated groups of trees and/or groups of trees with an average diameter of dominant and co-dominant trees greater than 24 inches at breast height (dbh) as directed/approved by the USFS Forester or Silviculturist.
- VG 2. All trees measuring 8 inches or greater in dbh that need to be removed shall be identified and marked for removal by a USFS Forester or Silviculturist prior to felling on NFS land.
- VG 3. For trees measuring 8 inches or greater in dbh, stump height shall not exceed 12 inches above ground level on the uphill side or 12 inches above natural obstacles. Trees less than 8 inches in dbh, stump heights shall not exceed 6 inches above ground level on the uphill side or 6 inches above natural obstacles.
- VG 4. Trees identified for removal will be whole tree yarded to log landings for disposal. Permits and/or contracts shall be issued prior to felling any trees greater than 8 inches dbh. All logs and slash will be removed from NFS land within 6 weeks to reduce insect and disease infestations. Woodchips not needed for restoration will also be removed from NFS land within 6 weeks.
- VG 5. Where removal of vegetation other than trees is unavoidable, the vegetation will be cut at ground level to preserve the root structure and allow for potential sprouting.
- VG 6. All areas of temporary ground disturbance that result from the construction or maintenance of the Project will be restored as required by the land management agency and per any applicable permits. Restoration will include restoring contours to their approximate pre-construction condition, stabilizing the area through seeding, mulching, placement of erosion control fabric, and installing erosion control features. Erosion control includes installing cross drains and placing water bars in the road, as needed.
- VG 7. Successfully restored areas will be defined as:

Reference sites will be pre-established and approved by the USFS. Reference sites will include plant communities that are representative of the ecological site and must include plant communities that are in a late-seral and ecologically

functioning condition. Appropriate reference sites will be determined by collecting baseline cover data to indicate plant succession and community structure.

- VG 8. Project implementation will comply with conditions in Lahontan Water Quality Control Board timber harvest waiver.

3.2.4 Herbicide Use (HE)

- HE 1. Herbicides will be used in accordance with label instructions, except where Project design features describe more restrictive measures. As applicable, an herbicide use plan will be developed and included as part of the Noxious Weed Species Plan (Appendix C1).
- HE 2. Prior to the start of application, all spray equipment will be calibrated to ensure accuracy of the delivered amounts of herbicide. Equipment used during herbicide application will be regularly inspected to ensure it is in proper working order.
- HE 3. Herbicide spray applications will not occur when wind velocity is 5 miles per hour or greater to further minimize the potential for drift.
- HE 4. Herbicide applications will not be conducted during rain or immediately following rain when soil is saturated or runoff or standing water is present. Application will occur only under favorable weather conditions, defined as:
- a) 30% or less chance of precipitation on the day of application based upon National Weather Service weather forecasting for the Reno area;
 - b) If rain, showers or light rains are predicted within 48 hours, the amount of rain predicted shall be no more than ¼ inch of rain; and
 - c) Rain does not appear likely at the time of application.
- HE 5. Preparation of herbicides for application, including mixing, filling of wands and rinsing of spray equipment, will take place outside of wetlands, meadows, riparian zones, wells and springs, and other sensitive sites, and more than 300 feet from surface water. Herbicide preparation will occur only on level, disturbed sites such as the interior of landings.
- HE 6. A spill cleanup kit will be readily available whenever herbicides are transported or stored. A spill kit will be carried by the applicator at all times when using the wicking application method.
- HE 7. Low nozzle pressure (<25 pounds per square inch), and a coarse spray (producing a median droplet diameter of >500 microns) will be used in order to minimize drift during herbicide applications.
- HE 8. Prior to treatments in areas of concentrated public use, the public will be notified about upcoming herbicide treatments via posting signs.
- HE 9. The herbicide spray nozzle will be kept as close to target plants as possible (within 20 inches) while achieving uniform coverage in order to limit overspray and drift to non-target vegetation.
- HE 10. Where riparian vegetation communities occur, herbicide application will be limited to directed foliar spray or wiping methods and spray will be directed away from native vegetation.

- HE 11. Herbicide treatments will not occur within 500 feet of sensitive plant occurrences.
- HE 12. Herbicide application within wet meadows will be limited to treating invasive plant infestations that occupy less than 100 square feet. Herbicide applications will be limited to wiping techniques with aminopyralid, chlorsulfuron, and glyphosate and treatment of the following high priority species: Canada thistle (*Cirsium arvense*), yellow star thistle (*Centaurea solstitialis*), Russian knapweed (*Acroptilon repens*) or tall whitetop (*Lepidium latifolium*) which are difficult to eradicate with non-chemical means. Meadows will be surveyed for special status plant species prior to any chemical treatments and will be monitored post-treatment to determine effects to non-targeted vegetation.
- HE 13. Herbicide application will not occur within the established buffers for aquatic features shown in **Table 3-3**.

Table 3-3 Minimum Buffers (ft) for Herbicide Application Near Aquatic Features

Herbicide	Application Method	Dry Aquatic Features	Streams ¹ or Ditches with Water ²	Wetland or Meadow
Aminopyralid	Spot & directed foliar spray	25	25	100
	Wiping	15	150	15
Chlorsulfuron	Directed foliar spray	25	100	100
	Wiping	15	15	15
Glyphosate	Directed foliar spray or drizzle	0	25	25
	Cut stump or wiping	0	15	15
Imazapic	Directed foliar spray	25	75	75
Triclopyr (TEA)	Directed foliar spray	25	75	75
	Wiping or cut stump	15	15	15
Clopyralid	Spot & directed foliar spray	25	50	50
	Wiping	15	15	15

¹As measured from the edge of the stream channel. If a defined channel is not present (draws do not have defined channels), measurement is from the bottom of the feature.

²As measured from the edge of the wet area or the meadow vegetation, whichever is greater. Limited conditions allowing for herbicide application within meadows are described in HE 17.

- HE 14. Herbicide application is limited to targeted treatments directed at the plant (spot treatments of the immediate area surrounding the plant are allowed with aminopyralid and clopyralid, only) using a backpack sprayer; broadcast spray methods that dispense chemical over a non-localized area will not be used.
- HE 15. Avoid application of Aminopyralid and Clopyralid sprayed mulch materials on revegetation sites.

3.2.5 Forest Health (FH) - Insects and Disease

- FH 1. To reduce the build-up or residual tree mortality by pine engraver beetles (*Ips pini*), and reduce fuel loading the following measures shall occur:



- a) Trees greater than 3 inches diameter at breast height (dbh) (whether in accessible or inaccessible areas) shall be removed (after proper permitting) to established log landings. Slash shall be chipped and hauled off of NFS land for disposal. All logs and slash shall be removed from NFS lands within 6 weeks of cutting. Any incidental breakage during whole-tree yarding that is 3 inches in diameter or greater shall be lopped and scattered to within 18 inches of the ground in open areas.
- b) Timing: In areas where material 3 inches or greater in diameter is left on site, cutting shall only occur from August 1 through December 31. Material must be lopped and scattered to within 18 inches of the ground in open areas. There are no timing restrictions for dead trees or species other than pine.

3.2.6 Water Resources and Soil (WA)

- WA 1. As a part of this COM Plan, a Storm Water Pollution Prevention Plan (SWPPP) will be prepared to minimize erosion from the Project construction worksites and to contain sediment (Appendix C5). The SWPPP will be prepared in accordance with the NPDES General Construction Stormwater Permit. At a minimum, it will identify the existing drainage patterns of the construction work sites and ROW/easement, nearby drainages and washes, potential pollutant sources other than sediment, and erosion and sediment control measures and BMPs that will be implemented to protect stormwater runoff. The SWPPP will include maps with locations for erosion and sediment control measures, and BMPs. The SWPPP will be kept on site throughout the duration of construction.
- WA 2. Erosion and stormwater controls will be inspected on the ground at least once every seven days and within 24 hours of a storm event of 0.5 inch or greater. Weather forecasts and data available from the National Weather Service in Reno will be used to determine total precipitation associated with a storm event. Qualified personnel of NV Energy or its contractors with specific training in erosion and sediment control will perform the inspections.
- WA 3. Construction equipment staging areas, and storage of equipment fuels will not be located within 300 feet of perennial streams or within 150 feet of intermittent and ephemeral streams. Staging areas and fuel storage will also not be located within 150 feet of wetlands or other water feature.
- WA 4. Pole sites and staging areas will not be constructed within the 100-year floodplain of any stream or within wetlands.
- WA 5. Construction equipment will not be operated on unstable soils or on soils too wet to adequately support equipment in order to prevent rutting, puddles on soil surface, or runoff of sediments directly into water bodies.
- WA 6. Topsoil removed from foundation holes will be separated and stockpiled at the edge of active work areas to salvage the seed bank.
- WA 7. Water drafting (i.e. water withdrawal) from streams will not be permitted. Water shall be provided by truck for dust abatement and other Project needs.

3.2.6.1 Temporary Stream Crossings

- WA 8. Improvements to any existing road crossing will be designed to minimize surface disturbance.
- WA 9. Crossings will be located where the stream channel is narrow, straight, and uniform, and has stable soils and relatively flat terrain. Stream crossings will be oriented perpendicular to the stream channel. All stream crossings will be designed and installed such that sufficient load-bearing strength for the expected equipment is provided.
- WA 10. Stream crossings will be designed for a normal range of flows for the site, and crossings that must remain in place during high runoff seasons will be stabilized. However, all crossings will be temporary and will be removed at the end of the construction season. The water body profile and substrate will be restored when the crossing is removed.
- WA 11. Stream crossings will be regularly monitored to evaluate the condition. Any repairs or improvements to the crossings identified during monitoring will be promptly addressed.
- WA 12. Surface drainage and roadway stabilization measures will be used to disconnect the access road from the stream in order to avoid or minimize water and sediment from being channeled into surface waters and to dissipate concentrated flows.
- WA 13. On perennial streams, existing crossings will be utilized and no new crossings will be constructed.
- WA 14. If it is determined that a stream crossing is needed and a Section 404 permit is needed an application for a permit will be completed at that time.
- WA 15. Perennial streams may have environmental resource designs which may include ramp crossings outside of ordinary high water mark.

3.2.7 Plants and Sensitive Plant Communities (SV)

- SV 1. If any USFS or BLM sensitive plant or federal- or state-listed species are identified during construction activities, the USFS will be contacted within 24 hours. Depending on the plant species appropriate protective measures will be implemented.
- SV 2. Prior to construction, once access roads and pole locations are known, the following tasks will be completed for areas where surface disturbance is planned:
 - a. Pre-construction surveys for jaw-leaf lupine, andesite popcorn flower, altered andesite buckwheat, and moonwort ferns;
 - b. Mapping and flagging of sensitive plant species, wetland areas, and noxious weeds; and
 - c. Noxious weed infestations will be treated according to design features NW1 and NW 2.
- SV 3. There will be no new access roads or widening of existing roads for construction access through meadows. This measure will also protect potential habitat for

special status plant populations that are found in wetland and meadow habitats, such as Dog Valley ivesia.

- SV 4. Poles, staging areas, and line clearance areas, and any Project-related ground disturbance will avoid all special status plant populations.
- SV 5. Where existing roads are used for travel to the Project site (but not widened), any road maintenance within 100 feet from special status plant populations will focus on avoiding impacts. A permanent physical barrier, such as lining the roads with rock or fencing the road corridor, will be constructed to prohibit vehicle access to sensitive plant populations and contain travel within the existing road corridor.

3.2.7.1 Webber Ivesia and Dog Valley Ivesia

- SV 6. Construction of new access roads (i.e., spur roads and centerline travel roads) and widening of existing roads and motorized trails will not occur within 500 meters (1,640 feet) of populations of Dog Valley ivesia (*Ivesia aperta* var. *canina*) and Webber ivesia (*Ivesia webberi*) occurring on NFS land. Allowable maintenance of roads within these habitat areas that do not require widening include blading and installation of erosion control measures. Construction of new temporary access roads and widening of existing roads and motorized trails will not occur within 200 feet of other special status plant populations that occur on NFS land. Within these buffer distances, travel and road maintenance on existing roads and motorized trails may be permitted but road improvements including widening of the existing travelled way are prohibited.
- SV 7. The transmission line will be excluded from the occupied habitat unit for Webber ivesia populations occurring on NFS land. (Occupied habitat includes the low sage habitat where the plants are present and a 500-meter buffer from the edge of the occurrence. The 500-meter buffer will include low sage and adjacent shrub steppe habitats to accommodate pollinators associated with the rare plant community).
- SV 8. Techniques to span over Webber ivesia potential habitat (i.e., unoccupied suitable habitat) will be evaluated with a USFS botanist. Unavoidable pole placement within habitat will require use of a helicopter. Access roads will not be constructed within potential habitat. Potential habitat includes low sage plant communities with specific habitat attributes: presence of a rocky pavement surface, presence of an argillic soil horizon, plant community composition and presence of associated plants, topographic position of the site, and, known elevation range. Areas defined as potential habitat will require the 500-meter buffer.
- SV 9. Placement of pole structures within the 500-meter buffer for Dog Valley ivesia may be unavoidable. The pole placement will be contained to the edge of the buffer to reduce potential impacts to the plant.

3.2.8 Wildlife and Sensitive Wildlife Species (WL)

- WL 1. If any USFS or BLM sensitive wildlife or plant species are identified during pre-construction surveys or during construction activities, work in the general area of the identified species will be halted until a USFS biologist or other qualified biologist is consulted to determine an appropriate buffer and other protective measures. The USFS will be notified within 24 hours of the discovery of the species. Buffer distance will be established in consultation with the USFS on a



case by case basis depending on species and type and magnitude of construction activity. If avoidance is infeasible, consultation with the USFS, and at its discretion, any cooperating agencies will be contacted prior to continuing work in the immediate area of the species. The same process will be implemented in the event that any federal- or state-listed species are discovered on public land, with the discovery being reported to the USFS or BLM, depending on the respective land administration.

- WL 2. If appropriate, additional surveys for northern goshawk and flammulated owl or other USFS sensitive species will be conducted prior to construction by a qualified biologist approved by the USFS. Coordination with the USFS will be conducted prior to commencing surveys to determine appropriate survey methodology, timing, and survey area. If nesting is detected the USFS will be contacted within 24 hours and Forest Plan standard and guidelines (USFS 2004) will be implemented. A designated Protected Activity Center (PAC) will be delineated around the nest site. Within the PAC no construction activities may occur during the "Limited Operating Period" April 15th - September 30th. Pole construction will need to be designed to span the PAC.
- WL 3. To reduce potential disturbance to migratory birds, construction will occur outside the typical avian breeding season (April 1 to July 31). If construction activities cannot be avoided during this time period, surveys will be conducted immediately prior to construction to locate active nesting areas.
- WL 4. If active avian nests are located on NFS land or BLM-administered public land, they will be flagged and avoided until after the breeding period. NV Energy will coordinate with the USFS or BLM biologist to determine appropriate time frames for resuming construction.
- WL 5. Excavations deep enough to potentially entrap wildlife species will be covered and fenced at night or when unattended to prevent livestock or wildlife from falling in. All covers will be secured in place and strong enough to prevent breakage by wildlife.
- WL 6. To avoid impacts to wintering mule deer, construction will not occur from November 25 through May 25 within areas mapped as crucial winter or winter-spring high deer use, including the Mitchell Canyon Deer Management Area. Non-ground disturbing activities, such as surveying, staking, or resource driven activities (e.g., cultural surveys, biological surveys), may occur within this time frame.

Please note: This Design Feature does not apply to work within fenced and cleared areas associated with the existing California and Bordertown substations, including the Bordertown substation expansion area that needs to be cleared and fenced prior to November 25.
- WL 7. To aid in providing browse for wintering mule deer, post construction revegetation in areas mapped as crucial winter and winter spring high use habitat will include seed mix of brush species preferred by mule deer (i.e., bitterbrush, mountain big sagebrush, mountain mahogany, serviceberry, snowberry, and Wyoming big sage) as well as appropriate forbs and grasses.
- WL 8. To ensure that impacts to wildlife habitat, particularly mule deer are no more than minor, vegetation that will be permanently lost or temporarily disturbed from the

Project, will require creation of or improvement of on or offsite wildlife habitat. To achieve this, NV Energy will fund a habitat restoration account that includes the cost of restoring three acres to every one acre of habitat that is permanently or temporarily disturbed. The account will be administered by NDOW or a Sierra Front Wildlife Working Group that will include NDOW, Washoe County, USFS, BLM, City of Reno and other interested participants.

- WL 9. To protect raptors such as hawks and eagles from electrocution, transmission line and pole structures will be constructed in conformance with the guidelines contained in Suggested Practices for Avian Protection on Power Lines: the State of the Art in 2006, prepared by the Avian Power Line Interaction Committee (2006).
- WL 10. To limit the potential for impacts to aquatic resources, particularly to Lahontan cutthroat trout, pole sites or roads will not be placed within the 100-year floodplain in Dog Creek, Bull Ranch Creek, and the Truckee River. During construction, no soil disturbing activities will occur within the 100-year floodplain of these streams.

3.2.9 Cultural Resources (CU)

- CU 1. Per Section 106 of the National Historic Preservation Act (36 CFR [Code of Federal Regulations] Part 800), cultural resources surveys will be necessary prior to any surface disturbance on lands not included in the baseline cultural resources analysis.
- CU 2. Cultural resources identified as eligible for the National Register of Historic Places (National Register) are considered Historic Properties. Adverse effects to Historic Properties are mitigated through approved treatment presented in the Project Historic Properties Treatment Plan, an appendix to the Memorandum of Agreement (MOA). Depending on approved treatment, some cultural resources will require the installation of avoidance fencing in addition to archaeological and Tribal monitoring during ground disturbing construction activity.
- CU 3. Cultural resources monitors (Archaeological and Tribal) will assess avoidance measures and monitor disturbance activities in culturally sensitive areas.
- CU 4. If previously unidentified cultural resources are discovered during mitigation, construction, monitoring, or reclamation, all work will cease immediately within a minimum distance of 100 feet from the discovery. All artifacts and materials will be left in place and measures to protect the discovery from further damage, theft, or removal will be implemented. The designated Project supervisor will notify the Forest Heritage Program Lead following “*Discovery of Cultural Resources*” outlined in the Inadvertent Discovery Plan, part of the MOA between identified parties and as provided in Appendix D1. The Forest Heritage Program Lead will ensure the proper Tribal representatives are notified.
- CU 5. If human remains or remains thought to be human, are discovered during construction activities, all work will cease and the area will be cordoned off with fencing or whatever means are available. No photos will be taken, and the USFS Heritage Program Lead will be notified immediately. The resulting work will follow “*Discovery of Human Remains*” outlined in the Inadvertent Discovery Plan as part of the MOA between identified parties and as provided in Appendix D1.



The USFS will fulfill the requirements of federal and state law by consulting with affiliated the State Historic Preservation Office (SHPO), Tribes, and other parties to determine whether the human remains are of recent age or criminal concern.

- CU 6. The USFS will ensure that employees or construction contractor(s) comply with federal and state laws. If the discovery is located on federal land, then the federal agency will take the lead on complying with the Native American Graves Protection and Repatriation Act (NAGPRA). If the discovery is located within any other jurisdiction, then state laws will be followed and the respective SHPO will take the lead. State laws include California Health and Safety Code 7050.5, California Public Resources Code 5097.98, and Nevada Revised Statutes 383.150 to 383.190 as amended by Senate Bill 244 in 2017.
- CU 7. Work in the immediate vicinity of the human remains may not resume until after the disposition of the human remains is determined and a written binding agreement is executed between the necessary parties in accordance with NAGPRA (43 CFR Part 10.4(e)). Resumption of work is USFS's decision. In most cases this will be the USFS District Ranger, but in the case where human remains are involved, it is recommended that the USFS Supervisor make this decision upon the advice of the USFS Heritage Program Lead and law enforcement officers.

3.2.10 Hazardous Materials and Waste (HM)

- HM 1. A Spill Prevention, Control, and Countermeasure Plan (SPCC) will be implemented during construction to prevent any spills. The SPCC will be developed by the construction contractor and submitted based on actual on-site needs. The SPCC, which will include cleanup procedures, will become part of this COM Plan (Appendix A2).

3.2.11 Recreation/Roads/Transportation (RT)

- RT 1. The use of any roads or trails will require compliance with the Carson Ranger District Motor Vehicle Use Map, including any restrictions for seasonal use.
- RT 2. All new temporary access roads and all improvements to existing roads will comply with: 1) The Forest Service National Supplements to the FP-03 (USFS, 2010); 2) the USFS Road Construction Handbooks (FSH 7709.56 and FSH 7709.57); and, 3) the Forest Plan.
- RT 3. All new access roads (i.e., spur roads and centerline travel roads) specifically constructed for this Project will be re-contoured and reclaimed and will have a physical closure installed to prevent motorized access immediately following the completion of construction and restoration. The types of closure and design specification used will be approved by the USFS prior to installation. Design specifications will be provided by the USFS.
- RT 4. Physical barriers such as boulders or natural features designed to harmonize with the natural environment of the surrounding area will be installed to prevent unauthorized vehicle use from occurring on restored roads. The use of gates or

other such structures for this purpose will be avoided unless determined necessary by the USFS. Design specifications will be provided by the USFS.

- RT 5. Maintenance activities which cause a road to be opened to unauthorized vehicles or damage to restoration improvements will need to be assessed and barriers reinstalled as needed at the expense of NV Energy.
- RT 6. Restored roads will require a signage and monitoring plan implemented by NV Energy for compliance with the closure which will include inspecting the barricade areas to determine the effectiveness of the blockades at preventing unauthorized motorized vehicle use of the restored access roads. Signs will notify the public that construction access roads are closed and are being restored. Signs will be replaced by NV Energy if vandalism occurs to the signs. Design specifications will be provided by the USFS.
- RT 7. If unauthorized vehicle use occurs on restored roads, barricades and reclamation will be monitored for effectiveness and remedial measures taken. Monitoring will continue until disturbed areas are successfully restored.
- RT 8. Public access will be maintained with minimal delays during the construction and maintenance of the Project. If there are traffic delays, NV Energy will post delay information at National Forest portals.
- RT 9. All construction vehicle movement will be restricted to the transmission line ROW/easement, pre-designated access roads, public roads, and private roads. All existing roads will be left in a condition equal to their preconstruction condition, according to the appropriate maintenance level including installation of water bars, and drainage features. The expectation is to return roads to preconstruction standards. High clearance roads will be returned to a state consistent with preconstruction conditions so as to not convey a false expectation to users.

3.2.12 Visual Resources (VI)

- VI 1. Non-specular conductors will be installed to reduce visual impacts.
- VI 2. The number of new poles will be minimized by increasing the pole span length on NFS land where the area is designated as Partial Retention for Visual Quality Objectives as terrain allows.

3.2.13 Fire Prevention and Response (FP)

- FP 1. Fire Prevention Plan will be implemented during construction activities to prevent and suppress fire. The Fire Prevention Plan will be included in this COM Plan (Appendix A1).

3.2.14 Air Quality (AQ)

- AQ 1. Vehicle and equipment speeds will be limited to 20 miles per hour on unpaved roads and on the ROW/easement.
- AQ 2. All areas subject to ground disturbance will be watered as needed to control dust.
- AQ 3. Paved roads will be swept if visible soil material is tracked onto them by construction vehicles.



- AQ 4. Excavation and grading activities will be suspended when winds (instantaneous gusts) exceed 50 miles per hour and visible dust persists that creates a health hazard to neighboring property owners and/or visibility impacts to vehicular traffic.
- AQ 5. In order to reduce construction equipment emissions, engines on construction-related vehicles will:
- Be tuned to the engine manufacturer's specification in accordance with an appropriate time frame;
 - Not be idle for more than five minutes (unless it is necessary for the operating scope of the equipment and operation);
 - Not be tampered with in order to increase engine horsepower;
 - Include particulate traps, oxidation catalysts and other suitable control devices on all construction equipment used at the Project site; and
 - Use diesel fuel having a sulfur content of 15 parts per million or less, or other suitable alternative diesel fuel, unless such fuel cannot be reasonably procured in the market area.

4.0 CONSTRUCTION ACTIVITIES

This section contains an overview of construction activities associated with the transmission line and substation facilities. **Figure 2** provides an overview of the transmission line route. Maps in **Volume I** provide details of the route, including structure locations, the ROW, construction staging areas, access roads, parcel numbers, and land ownership.

4.1 CONSTRUCTION SCHEDULE

Construction of the Project will take 18 to 24 months. A detailed schedule will be determined after construction contracts are awarded. Work may occur 12 hours per day any day of the week, except near sensitive receptors (i.e., occupied residences), where noise-generating activities (e.g., blasting) will be limited to Monday through Friday from 7:00 a.m. to 7:00 p.m.

4.2 LAND AND ENVIRONMENTAL SURVEYING

4.2.1 Pre-Construction Surveys and Staking

Prior to construction and as applicable, detailed surveys of all areas that could be affected by Project activities will be completed for vegetation, wetland resources, water resources, and special status species (plants and wildlife). The status of the surveys for the Project are detailed in **Table 4-1**.

Table 4-1 Pre-Construction Surveys Status

Pre-Construction Surveys	Status (As of July 2020)
Special Status Wildlife Species Survey	Spring/Early Summer 2021
Special Status Plant Species Survey	Pending - To be completed prior to construction. 2020/2021, as applicable
Vegetation Community Survey (transects established)	Completed by Western Botanical in 2017



Pre-Construction Surveys	Status (As of July 2020)
Noxious Weeds Survey	Scheduled for summer 2020
Water Resources and Wetland Survey	Completed – Results in Appendix C2
Geotechnical Report	Initial study completed in 2019 on private land. Additional geotechnical studies could be conducted once a construction contractor is hired for the Project.

All identified environmentally sensitive areas (i.e., culturally sensitive areas, meadows, and special status plant populations) will be temporarily fenced during construction for avoidance.

An engineering survey and subsequent staking of Project facilities will also occur prior to construction. Staking of facilities will include marking pole locations, anchor sites, staging of materials yards, access roads, and wire pull sites. Specific details can be found in the Flagging and Fencing Plan (Appendix B2).

4.3 SUBSTATION CONSTRUCTION

4.3.1 Site Preparation

The Bordertown Substation will be partially rebuilt and modified with the addition of new components in order to accommodate connection of the new transmission line. Expansion of the Bordertown Substation will begin with clearing vegetation and organic material from the construction areas. The site will then be graded to subgrade elevation. The existing chain link fence will be extended to include the new substation perimeter for security and to restrict unauthorized persons and wildlife from entering the substation. The site will be finish graded and gravel surfaced. Noxious weeds will also be treated and monitored to prevent spreading onto adjacent land. **Figure 3** illustrates the changes that will occur at the Bordertown Substation.

Parts of the California Substation will be rebuilt, and new components will be added to accommodate connection of the new transmission line. A new section 120-kV bus-work will be constructed at the substation and a new 120-kV transmission line terminal, including all associated switches, telecommunications and protections will be installed. All needed modifications will be accommodated within the existing fenced area of the substation, and the footprint of the existing substation will not be expanded (**Figure 4**).

4.3.2 Structural and Electrical Construction

Steel structures will be erected on concrete footings to support switches, electrical bus-work, instrument transformers, lightning arrestors, and other equipment, as well as termination structures for incoming and outgoing transmission lines. Structures will be fabricated from tubular steel and galvanized or painted and will likely match the color of the existing structures. Structures will be grounded by thermally welding one or more ground wires to each structure.

Major equipment will be set by crane and either bolted or welded to the foundations to resist seismic forces. Oil spill containment basins will be installed around major oil-filled transformers and other equipment. Smaller equipment, including air switches, current and voltage instrument transformers, insulators, electrical bus-work, and conductors will be mounted on the steel structures.



Control cables will be pulled from panels to be installed in control enclosures, through the underground conduits and concrete trench system, to the appropriate equipment. After the cables are connected, the controls will be connected to a telecommunications network, set to the proper settings, and all equipment will be tested before the new 120-kV transmission line is energized.

4.4 TRANSMISSION LINE CONSTRUCTION

4.4.1 Existing Access Roads

Existing roads will be used for construction and maintenance access as much as possible; however, some existing roads will be widened up to 30 feet, including cut and fill slopes to accommodate construction equipment. Roads that will be widened include designated NFS roads and non-system roads. Road improvements will comply with: 1) The Forest Service National Supplements to the FP-03 (USFS 2010); 2) the USFS Road Construction Handbooks (FSH 7709.56 and FSH 7709.57); and, 3) the Toiyabe Forest Plan (USFS 1986). Several designated NFS roads have seasonal use restrictions from April 1 to November 18 that will be followed during construction (RT 1). All designated NFS roads widened for construction or maintenance access will be restored to the original roadbed. NV Energy will comply with the design features, specified in Section 3.2, for all existing roads.

4.4.2 New Access Roads

New temporary access roads (i.e., centerline travel road and spur roads) will be constructed to pole sites, transmission wire setup sites, and staging areas when there are no existing roads available. Access roads will be up to 30 feet wide and located within the 300- to 600-foot-wide corridor (variable-width corridor). The variable-width corridor will be centered on the transmission line and will measure 300 feet wide where slopes are 10 percent or less, and 600 feet wide where slopes are greater than 10 percent. Temporary roads will be constructed primarily by mowing or masticating vegetation in a manner that leaves root systems intact to encourage regrowth and minimize soil erosion.

Whole tree removal will be required where new access roads cross forested areas. NV Energy will comply with design features for tree removal as described in VG 1 through VG 4 (Section 3.2.3). Rocks or other obstructions will be bladed. If rocks cannot be removed with heavy equipment, explosives may be used. While new access roads wider than 30 feet will not be expected, occasional widening beyond 30 feet may be necessary in areas where extensive blading and side cuts are required. Erosion and sediment controls will be installed as identified in the Project SWPPP (Appendix C5).

Following construction, all temporary access roads will be recontoured and stabilized by seeding, mulching, placement of erosion control fabric, and installing erosion control features such as water bars. Where deemed appropriate by the USFS, roads near sensitive resources may not be recontoured in order to avoid inadvertent disturbance to resources. Barriers will be installed on all restored access roads located on NFS land to prevent unauthorized vehicle use.

Vehicle access for transmission line maintenance is expected to be rare as the poles will be made of fire resistant metal, and there will be minimal other hardware or other attachments to the poles. Access will be necessary approximately every 10 years for close visual inspections and tree removal within the line clearance area. There are no permanent roads proposed to be kept for maintenance access.



4.4.3 Stream Crossings

Road construction across perennial streams will be avoided. Where improvements are needed to cross ephemeral and intermittent streams, the side slopes of drainages will be reduced to a slope that will allow safe vehicle travel, and the slopes and drainage bottom will be rock armored. Once construction is complete, all drainage modifications will be recontoured and seeded based on existing site conditions. Temporary stream crossing design features are described in detail in Section 3.2.6.

4.4.4 ROW/Easement Preparation

Prior to construction, noxious weeds will be inventoried, mapped, and treated within the ROW/Easement and areas within 100 feet of Project ground disturbance. Treatment methods will include manual and mechanical methods and the use of herbicides. A five-gallon backpack sprayer will be the primary method of herbicide application, but large infestations may require a truck-mounted sprayer. NV Energy will comply with design features NW 1 through NW 11 (Section 3.2.2).

During construction, vegetation will be removed as needed at pole sites, staging areas, transmission wire setup sites, and access roads. Removal of vegetation will generally consist of mowing or masticating shrub and grass vegetation in a manner that leaves root systems intact to encourage growth and minimize soil erosion.

In forested areas and as needed, trees will be identified and cruised according to USFS standards. Once identified, applicable trees will be removed prior to construction activities using heavy equipment where terrain and slope stability permits and skidded to log landings for disposal. In areas that are not accessible with equipment or with excessive slopes and highly erodible soils, trees will be removed by helicopter. All slash will be chipped and removed from NFS land within six weeks to reduce insect and disease infestations.

Trees within the transmission line ROW/easement will be removed as necessary for compliance with National Electric Safety Code (NESC), North American Electric Reliability Corporation standards, California Public Utilities Commission (CPUC) regulations, Nevada Administrative Code (NAC), California Public Resources Code, California Code of Regulations, and Department of Forestry Fire Prevention standards. The NESC standards and the California and Nevada codes require that obstructions be no closer than 21 feet to an overhead transmission line. **Figure 5** shows the typical tree clearance distances that will be required for compliance with the aforementioned codes and regulations.

4.4.5 Power Pole Structures

Single pole structures will be approximately 65 to 90 feet tall, dependent on terrain and obstructions (**Figure 6**). The two-pole H-frame structures will consist of two poles connected by an "X-brace". A horizontal cross-arm member will be mounted above the "X-brace" and will support the electrical transmission conductors (**Figure 7**). The three-pole dead end/angle structures will consist of three inline poles. The electrical transmission conductors will connect to insulators attached directly to the pole structure and the conductor jumper around the poles on a horizontal cross-arm member mounted to the three poles (**Figure 8**). The two-pole H-frame structures and the three-pole dead end/angle structures will be approximately 50 to 90 feet tall, depending on terrain or obstructions. Support structures taller than 90 feet may be required at isolated locations to accommodate road crossings, unique geographical features, or other existing overhead utilities. Weathered steel,



characterized by a stable, rust- like finish that closely resembles the color of wood poles, will be used for all pole structures.

The pole structures will support three aluminum composite core conductors that are approximately 1.5 inches (1949 thousand circular mils) in diameter. All conductor wires will be at least 22 feet above the ground surface. A single fiber optic shield wire approximately 0.375 to 0.75 inch in diameter will be placed along the top of each pole to protect the transmission line from lightning. Two-pole H-frame and three-pole dead end/angle structures will also have second steel shield wire approximately 0.375 inch in diameter along the top of the second pole to protect the transmission line from lightning. Copper or copper alloy ground wires will be affixed to each pole and connected to ground rods that will be buried in the excavation for each pole. The ground wires and rods will enable all of the poles to be electrically grounded. The transmission line will be designed and constructed to meet or exceed the requirements of the NESC; NAC 704.450: Regulation of Public Utilities, which adopts NESC by reference; and CPUC General Order Number 95: Rules for Overhead Electric Line Construction (State of California, 1998).

4.4.5.1 Pole Sites

A pole site is the area needed for the construction and installation of the pole structure and could be 0.5 to 1 acre in size depending on the type of pole structure. Clearing of vegetation at pole sites will be limited to the area excavated for the installation of the pole structures and what is needed for safe operation of construction equipment. Pole sites in steeper terrain (greater than 10 percent to 12 percent slopes) will be graded level for safe operation of equipment. Equipment pads will not be recontoured, but reseeded so that the pad will be available for future maintenance of the pole, if needed.

4.4.5.2 Excavation and Pole Foundations

Excavation for poles set directly into the ground with no foundation will be approximately three feet in diameter and approximately 10 to 13 feet deep. Single and three-pole dead-end/angle poles will be secured (guyed) by anchors installed in the ground approximately 60 feet from the pole base. The anchors will require excavating a hole approximately three feet in width and 10 feet deep. A truck-mounted power auger is the preferred method of excavation. However, backhoe excavation and blasting may be used as alternative excavation methods as geological and site conditions require. Poles that will be set in the ground without a foundation will be backfilled with native or imported fill material. Final pole foundation requirements will be determined after design and permitting requirements are completed.

In places where guying single and three-pole dead-end/angle poles will not be feasible, self-supporting steel angle poles on foundations will be installed. Concrete foundations, where needed, will be cast-in-place and dimensions will vary from 12 to 40 feet below ground surface and three to 12 feet in diameter. Should rocky areas be encountered, foundation holes may be excavated using rock drills and blasting. Topsoil removed from foundation holes will be separated and stockpiled at the edge of active work areas to salvage the seed bank. All excavations will be covered and temporarily fenced during weekends, holidays, night hours, or to protect the public and wildlife from injury.



4.4.5.3 Power Pole Assembly

Materials, including the transmission poles, insulators, guy wire anchors, and all other associated hardware, will be delivered from staging areas to each of the pole sites. Assembly crews will build the structure and then attach insulators, travelers, and hardware to assemble a complete structural unit. Erection crews will follow and place the completed poles into the excavated holes using a large mobile crane or helicopter. Equipment pads will be established at the pole sites, where necessary, to support the equipment for the crew to erect the pole. Native soils previously excavated, imported backfill, and/or concrete will be placed around each pole and properly compacted. Guy wires to support the angle poles will be used to plumb the structure. Signs, flagging, or other readily visible marking will be used to indicate the presence of guy wires to reduce the potential for people and wildlife to run into the wires. Where self-supporting steel angle poles are required, anchor bolts will be used to secure the pole structure to the poured concrete foundation.

4.4.5.4 Transmission Wire Setup Sites

Conductor and shield wire installation will be performed from transmission wire setup sites. Transmission wire setup sites will be up to 600 feet in radius. Up to 14 wire setup sites have been initially identified as been needed. The number of sites is a function of wire reel span lengths and engineering requirements for conductor sagging.

4.4.5.5 Conductor and Shield Wire Installation

The installation of conductors and shield wires is a four-step process:

1. Install guard structures (where necessary);
2. Install sock line (wire pull ropes);
3. Pull conductors and shield wires; and
4. Sag conductors and shield wires to appropriate tension and connect to the insulators with clamps.

The temporary guard structures will be removed following the completion of conductor stringing operations and the holes will be backfilled with excavated soil. As an alternative to guard structures, flaggers may be used to temporarily hold traffic for brief periods of time while the overhead line is installed at road crossings.

Travelers or stringing blocks will be attached to the insulators prior to pole setting. The travelers allow the conductors to be pulled between poles until the entire line is ready to be clipped in and pulled up to the final tension position. Conductor stringing operations begin by pulling a sock line (a small cable or rope used to pull the conductor) onto the travelers from pole-to-pole using aerial manlifts, helicopter, or a construction vehicle traveling along access roads or the centerline travel route. Once the sock line is installed, it will be attached to reels of conductor or shield wire at the wire setup sites and pulled through in the reverse direction back through the travelers. During the pulling process, enough tension will be maintained to keep the wires above the ground, avoiding any damage to the conductors due to dragging. After the conductors and shield wires are strung, they will be sagged to the proper tension and clipped into the insulators.



4.4.6 ROW/Easement Restoration and Reclamation

All construction access roads constructed on NFS land will be recontoured and reclaimed. All existing authorized NFS roads and motorized trails that are widened for construction access will be reclaimed and returned to the original roadbed. Non-designated roads on NFS land that will be widened and used for construction access will be reclaimed and reseeded. Restoration will include recontouring roads, installing erosion control features such as drain dips, ripping, chipping, and seeding. Logs, branches, pine needles, brush, and rocks may be used to disguise the road for restoration purposes or other techniques approved by the USFS. Restoration success will be monitored until restoration is deemed successful by the USFS. Refer to the Reclamation and Habitat Restoration Plan (Appendix C3) for greater details on Project reclamation.

4.5 FENCES AND GATES

Construction activities may require temporary access through existing fences and gates on public and private land. Fencing will be replaced when construction activities are completed. Replacement fencing will be built to agency or landowner specifications, consistent with the fencing that was removed. During construction, fences with open gates will remain open and fences with closed gates will remain closed. Fences crossed during construction will be braced and secured prior to cutting the fence to prevent slackening of the wire.

4.6 STAGING AREAS

One staging area has been established to support construction activities for the Project. The location is shown on figures in Volumes I and II. The staging area will be needed to store construction materials, equipment, tools, fuel, service trucks, spare parts, and vehicles as well as house portable, self-contained toilets and possibly portable offices or serve as equipment maintenance areas. A staging area that was originally identified adjacent to the Bordertown Substation was eliminated from consideration following a noxious weeds survey that identified an abundance of noxious weeds in the area. A new staging area in the northern Project Area will be identified by NV Energy and surveyed for noxious weeds prior to construction, and if needed, appropriate noxious weed treatment would be implemented. The staging areas will measure approximately 500 feet in length by 500 feet in width and will use previously disturbed ground or areas immediately adjacent to existing disturbance. Any hazardous materials such as fuel, lubricants, and solvents, will be handled and stored in accordance with applicable regulations, including 40 CFR 262. Handling, storage, and clean-up of hazardous materials at the staging areas will be described in the Hazardous Materials Management and Spill Prevention Plan (Appendix A2). The staging areas will include secondary containment to capture and contain any potential spills or leaks.

4.7 HEALTH AND SAFETY

NV Energy has provided health and safety information for NV Energy employees and construction contractor crews, within the appendices to this COM Plan. Specifically, the Fire Protection and Suppression Plan (Appendix A1) contains fire safety information; the Hazardous Materials Management and Spill Prevention Plan (Appendix A2) contains information for spill prevention; the Emergency Preparedness and Response Plan (Appendix A3) details measures to deal with emergency situations including COVID-19; and the Blasting Plan (Appendix A4) contains safety information with regard to blasting procedures.



4.8 ACCIDENT REPORTING

The USFS will be notified by NV Energy of any accidents occurring on public lands during construction of the Project. Notification procedures for emergencies are described in the Emergency Preparedness and Response Plan (Appendix A3).

4.9 ENVIRONMENTAL COMPLIANCE PROGRAM

NV Energy has developed an Environmental Compliance Program that will be implemented throughout the duration of the Project to provide guidance and standardized procedures for Project compliance. NV Energy will use a designated Environmental Compliance Team to monitor construction activities and track compliance with the EIS design features, the USFS SUP, the BLM ROW Grant, and other applicable permits.

4.9.1 Roles and Responsibilities

4.9.1.1 NV Energy

NV Energy is responsible for establishing and implementing the Environmental Compliance Program to oversee construction by its contractor(s) from an environmental compliance viewpoint. NV Energy's Environmental Compliance Team is presented in **Table 4-2** below:

Table 4-2 NV Energy Environmental Compliance Team

Position	Responsibility
NV Energy Management Team	
Project Manager – Laura Clifford	Compliance Reporting
Environmental Compliance Manager - Lee Simpkins	Permits and Agency Coordination
ROW Agent - Nate Hastings	Property Owner Notification
Construction Manager - Terry Saunders	Oversees Construction Contractor(s) and Coordinates with Environmental Field Supervisor
Senior Construction Administrator - TBD	Administers Material and Construction Activities
COM Plan Liaison – Greg Brown (Stantec)	Provides input on design features and COM Plan
Resource Specialists (As Needed)	Provides guidance on implementing design features and identifying sensitive resources in the field
Single Inspection Program (SIP) Team	
Environmental Field Supervisor – Ben Veach	Directs team of Environmental Field Inspectors and coordinates with NV Energy Construction Manager, and Prime Construction Contractor
Environmental Field Coordinator – Mike Derby	Office support for SIP Team and coordinates all environmental compliance documentation
Environmental Field Inspectors – Mike Derby/Nancy Lightfoot and others as needed	Monitors construction activities in the field for environmental compliance. The number of positions will vary with construction requirements.



Position	Responsibility
Cultural Resources Team	
Senior Archaeologist – Albert Garner	Directs team of Cultural Resource Inspectors and coordinates with NV Energy Construction Manager, and Prime Construction Contractor
Principal Investigator – Vickie Clay	Senior oversight for cultural resources.

Key to the success of this compliance effort will be the use of an objective SIP team of consultants. The SIP team has been contracted by NV Energy and has experience conducting environmental field monitoring of large-scale construction Projects. The SIP team consists of an Environmental Field Supervisor, Environmental Field Coordinator, and Field Inspectors.

The SIP team leadership (Environmental Field Supervisor and Field Coordinator, at a minimum) and the NV Energy Project Manager, Environmental Compliance Manager, and Construction Manager will hold meetings, as appropriate, with the USFS before construction starts. The purpose of these pre-construction meetings is to establish the communication and reporting protocols that will be used during the construction phase, and eventually, during the operation and maintenance phase.

4.9.1.2 USFS

The USFS is the federal lead agency for the Project and has the primary authority for monitoring the performance and effectiveness of the environmental compliance program on federal lands as mandated under NEPA. The BLM will also be responsible for compliance with the BLM ROW Grant requirements.

4.9.2 Compliance Levels and Reporting

NV Energy will maintain a compliance documentation system describing the compliance levels and will use it as a tool to help explain, record, and enforce the compliance requirements. The following levels of compliance measurement will be used for the Project:

- Compliance - Used to identify an action in accordance with all project requirements;
- Notification - Used to identify an action approaching non-compliance. This is a "fix-it" notice;
- Non-Compliance - This term identifies an action that does not comply with a Project requirement. A Non-Compliance Report will be issued. A repeat Non-Compliance will be noted on a Non-Compliance Report as a second occurrence. A Non-Compliance Resolution Report must be approved by the USFS for each Non-Compliance Report to demonstrate compliance; and
- Stop Task Order – A third repeated Non-Compliance Report will result in a Stop Task Order. A Stop Task Order would require NV Energy to meet with the USFS to determine actions to correct or resolve the issue and resume activity in the problem area.

Compliance forms for Notification, Non-Compliance Reports, and Non-Compliance Resolution Reports are provided in **Tables 4-3, 4-4, and 4-5**, respectively.



Table 4-3 Notification Form

NOTIFICATION FORM	NV ENERGY
BORDERTOWN TO CALIFORNIA 120 KV TRANSMISSION LINE PROJECT	
Notification Number: <input style="width: 150px; height: 20px;" type="text"/>	Date: _____ Issued to: _____
Inspector: _____	Time: _____
Structure Number: _____	
Sheet Map Number: _____	
BE AWARE THAT THE FOLLOWING PROJECT CONDITIONS ARE NOT BEING MET:	
TO FIX OR CORRECT THE CONDITION YOU MUST:	
<p>If this condition is not resolved satisfactorily by _____, a non-compliance report will be issued.</p> <p>Your prompt attention to this matter is appreciated.</p>	
<p>Notification Resolved: _____</p> <p style="text-align: center; font-size: small;">(SIGNATURE)</p>	<p>_____</p> <p style="text-align: center; font-size: small;">(NAME—PLEASE PRINT)</p>
	<p>_____</p> <p style="text-align: center; font-size: small;">(DATE)</p>

The final format and content of this form is dependent upon the selection of the consultant for the SIP Team and is subject to approval by the USFS prior to the start of construction.

Table 4-4 Non-Compliance Report

NON-COMPLIANCE REPORT (NCR)	NV ENERGY
BORDERTOWN TO CALIFORNIA 120 KV TRANSMISSION LINE PROJECT	
NCR Number: <input style="width: 150px;" type="text"/>	Date: _____ Other Parties at Site: _____
Inspector: _____	Time: _____
Structure Number: _____	
Sheet Map Number: _____	
Non-Compliance Level: <input type="checkbox"/> Non-Compliance <input type="checkbox"/> Stop Task Order	
Land Ownership: <input type="checkbox"/> Private <input type="checkbox"/> Federal	
In Non-Compliance With: <input type="checkbox"/> FEIS <input type="checkbox"/> COM Plan <input type="checkbox"/> State Permit <input type="checkbox"/> Federal Permit	
Mitigation Measure Number/Permit and Condition Number: _____	
Describe Resource Impact: _____	
Describe Activity That Resulted in Non-Compliance: _____	
Documentation: <input type="checkbox"/> Photo <input type="checkbox"/> Video <input type="checkbox"/> Drawing <input type="checkbox"/> Lab Sample <input type="checkbox"/> Other _____	
Communication: <input type="checkbox"/> USFS _____ <input type="checkbox"/> NV Energy _____ <input type="checkbox"/> BLM _____	
<input type="checkbox"/> Contractor _____ <input type="checkbox"/> Other _____	
Requirements for Resolution: _____	
Resolved by: _____ (SIGNATURE) _____ (NAME—PLEASE PRINT) _____ (DATE)	

The final format and content of this form is dependent upon the selection of the consultant for the SIP Team and is subject to approval by the USFS prior to the start of construction.



4.9.3 Project Changes

A certain amount of change during the course of any project is inevitable. Once Project construction begins, changing conditions or unforeseen situations may arise. These changes could be such that they were not specifically addressed in the EIS document and may require further environmental analysis and agency approval. To examine change to a Project design feature, construction activity or location, the SIP Environmental Field Inspector(s) will propose a Change Evaluation (CE).

The focus of a CE is a deviation from the Project described and evaluated in the USFS EIS. The CE process described below is designed to assure the USFS that any given change will avoid significant environmental impacts. It will be the responsibility of the Environmental Field Supervisor and the NV Energy Construction Manager to facilitate approval of Project changes.

Changes can fall into one of two categories: major or minor. A major change will require a CE Form to document responsible evaluation of the Project change and must be approved by the USFS. A minor change can be approved by a SIP Environmental Field Inspector, but it also must be documented with a CE Form that will be reported to the USFS weekly. **Table 4-6** provides examples of the types of Project activities that would constitute a major or a minor change.

Table 4-6 Examples of Major and/or Minor Changes

Activity	Major Change	Minor Change
Any change involving a cultural resource site.	X	
Any change involving a federally listed plant or animal species.	X	
Any Project activities outside of the 300-foot (600-foot wide corridor in areas of steep terrain) or expanded study corridor (except for "previously studied" access roads and material yards).	X	
Any design feature modification to an EIS design feature that is necessary due to infeasibility.	X	
Adding new helicopter fly-yard within an existing study corridor.		X
Cut a tree or trees not marked for removal.		X
Move a wire stringing area to another area without sensitive resources.		X
Change construction procedures. This could fall in the major or minor category, depending if the change is substantially different than discussed in the EIS.	X	X
Temporary use of a road in a buffer zone to access work zone.		X
Temporary encroachment in a buffer zone.		X
Perform improvements on access road previously described as requiring no improvement.		X
Refuel within 100 feet of water course with proper containment devices.		X
Waiver of design feature (because of error in resource identification or resource no longer in existence).		X
Work after designated/restricted construction hours.		X

A sample CE Form is provided in **Table 4-7**.

Table 4-7 Change Evaluation Form

CHANGE EVALUATION (CE) FORM		NV ENERGY
BORDERTOWN TO CALIFORNIA 120 KV TRANSMISSION LINE PROJECT		
Evaluation Number:	<input style="width: 150px; height: 20px;" type="text"/>	Date: _____ Phone: _____
Inspector:	_____	Time: _____
Structure Number:	_____	
Map Number:	_____	
Evaluation Type:	<input type="checkbox"/> Minor Change	<input type="checkbox"/> Major Change (Requires USFS or BLM Approval)
Land Ownership:	<input type="checkbox"/> Private	<input type="checkbox"/> Federal
Describe Change/Purpose:	_____	
Type of Resources:	_____	
Summary of Impacts:	_____	
Proposed Mitigation Measures:	_____	
Change From:		
<input type="checkbox"/> FEIS Mitigation or Design Feature	_____	
<input type="checkbox"/> COM Plan	_____	
<input type="checkbox"/> Project Description	_____	
<input type="checkbox"/> Permit Conditions (list permit number and condition/requires permitting agency approval):	_____	
Reviewed by:	_____	_____
	<small>(SIGNATURE)</small>	<small>(NAME—PLEASE PRINT)</small>
		<small>(DATE)</small>

The final format and content of this form is dependent upon the selection of the consultant for the SIP Team and is subject to approval by the USFS prior to the start of construction.



4.9.4 Communications

NV Energy will have the primary responsibility for communication with the USFS personnel regarding compliance with Project conditions and design features and regarding periodic compliance inspections. NV Energy will also have the primary responsibility for notifying property owners of upcoming construction activities and ensuring that construction contractor(s) are trained on how to interact with property owners and other members of the public during construction.

Additional details regarding emergency notification of agencies (e.g., in case of wildfire, spills, discovery of a burial site, or other unforeseen circumstances) are presented in the COM Plan appendices. The Key Contacts List at the beginning of this COM Plan will also be updated by NV Energy as needed to provide a convenient reference during such situations.

4.9.5 Environmental Training Program

NV Energy and the construction contractor(s) will conduct an environmental training program to educate managers and field crews on compliance with the COM Plan. The training will include but not be limited to:

- Role of the environmental compliance team;
- Individual responsibilities;
- Compliance monitoring and reporting process;
- Approval of Project changes;
- Discussion of pertinent requirements.

NV Energy will conduct a multi-hour training program for positions that are foremen level and higher and may conduct a less than one-hour training for construction crew workers. The training will be conducted before construction personnel begin work on the Project. Due to the high turnover rate associated with construction crews and foremen will be required to keep track of and require training of all construction personnel under their supervision. Additional training will be conducted as needed to inform new personnel brought on the job during the construction period. All training will be done by qualified personnel.

4.10 CONSTRUCTION WORKFORCE AND EQUIPMENT

The workforce will consist of approximately 50 to 100 workers for construction of the transmission line. The number of workers will vary depending upon the construction phase, and will include surveyors, construction inspectors, linemen, laborers, operators, supervisors and biological monitors, as required. The anticipated workforce for construction at the substations will consist of 10 to 20 people per substation, including surveyors, construction inspectors, journeyman substation electricians, relay technicians, telecommunication technicians, laborers, operators, and supervisors and biological monitors, as required.



4.11 WASTE DISPOSAL

For the purposes of this COM Plan, waste refers to all discarded matter, such as trash, sanitary waste, scraps, salvage materials, hazardous materials, and petroleum products, etc. Waste materials at construction sites will be disposed of appropriately and promptly, as described in the Hazardous Materials Management and Spill Prevention Plan (Appendix A2). All construction sites throughout the Project area will be maintained in a sanitary condition at all times, and waste will be disposed of frequently so as not to attract animals or create health or safety issues. Construction sites will be monitored daily to avoid the potential for air-blown refuse being scattered.

4.12 CLEANUP AND RESTORATION

This section summarizes cleanup and reclamation activities that NV Energy and its construction contractor(s) will implement during and upon completion of construction activities. Reclamation and reseeding activities are described in more detail in the Reclamation and Habitat Restoration Plan (Appendix C3).

4.12.1 ROW Cleanup

At structure sites in steep terrain, an approximate 0.25-acre level pad will be retained for equipment access to structures for 10-year inspection and repairs; the rest of the structure site disturbance will be recontoured. All structure site disturbance (including the equipment pads retained for future inspections) will be de-compacted, stabilized and reseeded with Agency-approved weed-free seed mixes. Different seed mixes and seeding rates will be required for various portions of the Project depending upon the vegetation community, substrate, and elevation.

4.12.2 Access Road and Centerline Travel Route Reclamation

NV Energy is not proposing a permanent access road along the entire length of the transmission line. Using as many existing access roads as possible, the minimum necessary number of new roads and spur roads will be constructed as needed. Existing access roads that have been widened to transport construction and equipment and materials will be returned to their preconstruction widths. Centerline travel routes and other areas within the ROW/easement disturbed by construction activities will be recontoured, de-compacted, and seeded. NV Energy will attempt to close or restrict vehicle access to areas that have been seeded until the reclamation success criteria have been met and issued the appropriate certificate of Project completion.

5.0 OPERATION AND MAINTENANCE ACTIVITIES

After construction is complete, NV Energy will implement the following operation and maintenance procedures.

5.1 STANDARD OPERATING PROCEDURES

The transmission line will be remotely operated from NV Energy's Electrical Control Center in Reno, Nevada. The Electrical Control Center will monitor voltage and power flow along the transmission line in accordance with NV Energy's standard operating procedures. If operations must be temporarily ceased and the transmission line de-energized to protect human life and property, NV Energy's headquarters in Reno must be contacted at (775) 834-3541 or (775) 834-4100 and informed of the specific situation and location of the problem. The transmission line can be remotely de-energized from NV Energy's Reno headquarters.

5.2 NEW OR RECONSTRUCTION ACTIVITIES AND STANDARDS

If during transmission line maintenance and monitoring, it is determined that new or reconstruction activities should be implemented, NV Energy will notify the USFS, BLM, property owners, and/or other regulatory agencies, and obtain proper approvals, as necessary.

5.3 MAINTENANCE ACTIVITIES AND STANDARDS

Once the transmission line is operational, NV Energy will conduct annual inspections of the line to check for maintenance needs. One close visual structure-climbing inspection is anticipated every ten years. NV Energy will also patrol the ROW/easement after unexplained outages or significant natural incidents (such as fires, earthquakes, floods, torrential rains, or extreme electrical storms) to observe the facility conditions and surrounding environment and to begin repairing any damages. The inspections will be conducted by one or more NV Energy workers by pickup trucks or all-terrain vehicles (ATVs) generally following the centerline travel route used for Project construction. In areas where the centerline travel route has been reclaimed or for other reasons there is limited or difficult access, or there is insufficient time to inspect the line by truck or ATV, one or more NV Energy workers in a helicopter will conduct inspections.

Trees that could interfere with the safe operation of the transmission line will be pruned or removed as needed over the life of the Project. It is anticipated that selective tree removal or pruning beneath the transmission line will be required every ten years. As previously described, hazard trees which may fall on the line or may come into contact with the line from the side will also be removed. Hazard trees include dead trees, old decadent or rotten trees, and trees weakened by disease. Removal of hazard trees and trimming or removal of trees to provide safe clearance distance between conductors and vegetation is required to meet national industry safety standards and federal and state regulations. (NESC requirements for safe clearance for electrical wires; Federal Energy Regulatory Commission-approved North American Electric Reliability Corporation Standard FAC-003-01 Transmission Vegetation Management Program; CPUC General Order No. 95 Rules for Overhead Electric Line Construction; California Public Resources Code 4293: Power Line Clearance; and California Code of Regulations Title 14 Sections 1250-1258: Department of Forestry Fire Prevention Standards for Electric Utilities.) NV Energy will obtain proper approvals, as necessary, to perform required maintenance activities.



5.4 RIGHT-OF-WAY OPERATIONS

The USFS has authorized the SUP for a transmission line ROW across NFS land in perpetuity.

The BLM has authorized a ROW Grant amendment for the substation expansion and section of transmission line across BLM-administered lands in perpetuity with the right of renewal.

5.5 EMERGENCY PROCEDURES

Detailed emergency response information is included in the Emergency Preparedness and Response Plan (Appendix A3). Emergency response procedures will be implemented for the following potential events, or other similar events:

- Downed transmission lines or structures;
- Discovery of human remains or cultural resources (Inadvertent Discovery Plan - Appendix D1);
- Fire (Fire Prevention and Suppression Plan-Appendix A1);
- Sudden loss of electrical power;
- Natural disaster; and
- Serious personal injury.

6.0 TERMINATIONS AND ABANDONMENT OF RIGHT-OF-WAY

Prior to the ultimate termination or expiration of the federal SUP, or any portion thereof, NV Energy will contact the USFS and BLM Authorized Officers to arrange for a pre-termination meeting and joint inspection of the ROW.

The meeting and inspection will be held to agree to an acceptable termination and rehabilitation plan. This plan will include, but not be limited to, removal of facilities and surface improvements, reclamation, reseeding, and monitoring. The Authorized Officer must approve the plan in writing prior to commencement of any termination activities. After completion of the termination activities and upon final inspection and approval by the USFS Authorized Officers, NV Energy will relinquish all, or those specified portions, of the SUP.

7.0 REFERENCES

- Avian Power Line Interaction Committee. 2006. Suggested Practices for Avian Protection on Power Lines: The State of the Art 2006. Washington, D.C., and Sacramento, California: Edison Electric Institute, Avian Power Line Interaction Committee, and the California Energy Commission.
- State of California. 1998. Rules for Overhead Electric Line Construction. Prescribed by the Public Utilities Commission of the State of California.
- United States Forest Service (USFS). 1986. Toiyabe National Forest Land and Resource Management Plan. U.S. Department of Agriculture, Forest Service, Toiyabe National Forest.
- USFS. 2004. Sierra Nevada Forest Plan Amendment, Record of Decision (ROD). Vallejo, California: U.S. Department of Agriculture, Forest Service, Pacific Southwest Region and Intermountain Region.
- USFS. 2010. The Forest Service National Supplements to the FP-03. Retrieved on May 22, 2013, from:
<http://www.fs.fed.us/eng/transp/documents/doc/FSSdirections091410.doc>.
- USFS 2018. Final Environmental Impact Statement. Bordertown to California 120 kV Transmission Line Project. Humboldt-Toiyabe National Forest. Washoe County, Nevada. Sierra County, California. June 2018
- USFS. 2019. Final Record of Decision. Bordertown to California 120 kV Transmission Line Project. Humboldt-Toiyabe National Forest. Washoe County, Nevada. Sierra County, California. June 2019.

FIGURES

V:\2037\Active\203703160\03_data\figs_cad\figs\mxd\ Preliminary_Figures\Fig1_General_Location_8x11P.mxd Revised: 2019-03-04 By: Jrook

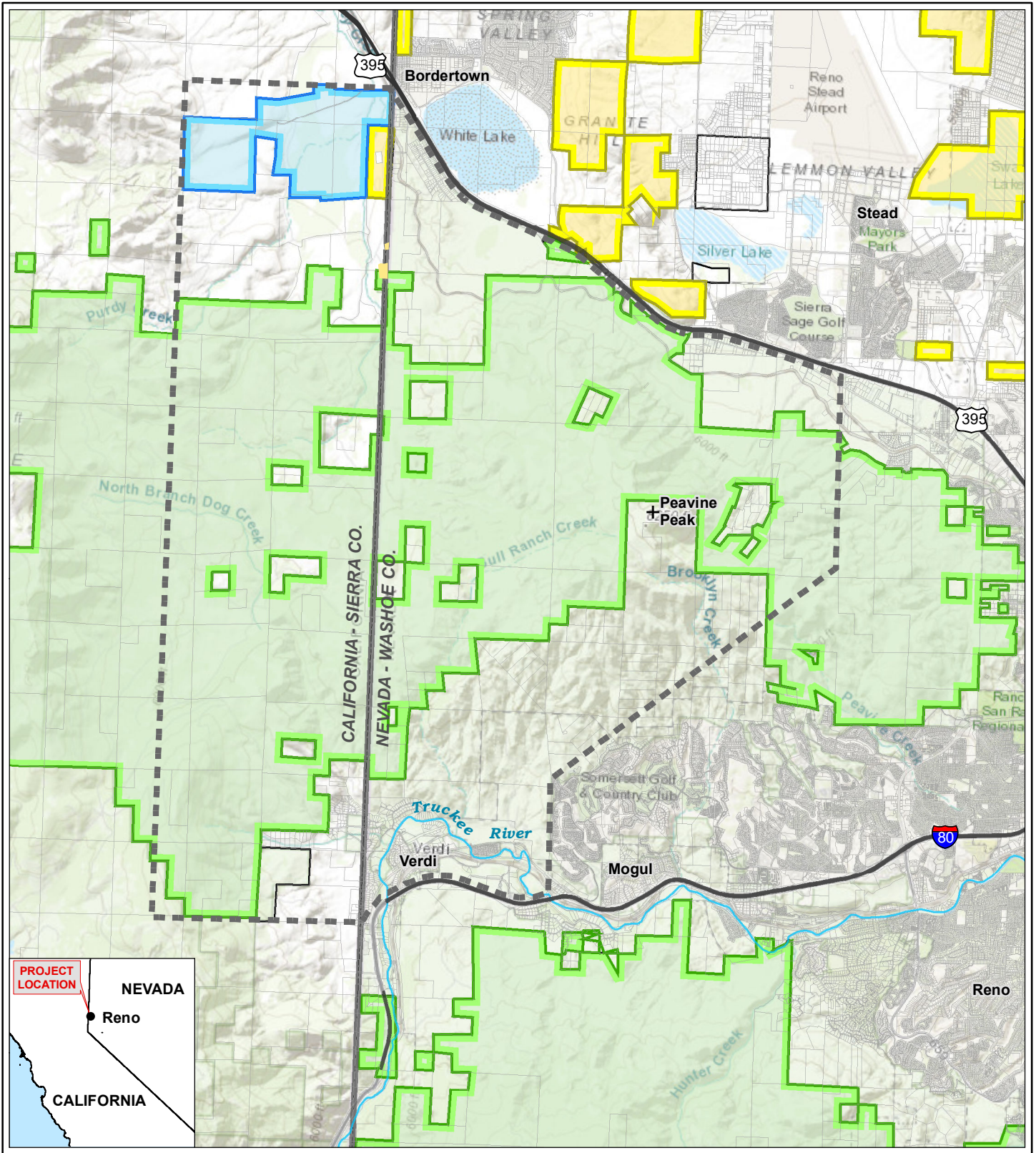

Legend

- Project Area
- Land Ownership**
- U.S. Bureau of Land Management
- U.S. Forest Service
- California Department of Fish & Wildlife



0 5,000 10,000 Feet
1 in = 10,000 feet

Sierra County, CA & Washoe County, NV NAD 1983 UTM Zone 11N		
DRAWN BY: JT	1ST REVIEW: CJ	2ND REVIEW: KC
DATE: 3/4/2019		PROJECT NO: 203703160

NV Energy
Bordertown to California 120 kV
Transmission Line Construction,
Operation, and Maintenance (COM) Plan

**Figure 1
General Location**

Disclaimer: Stantec assumes no responsibility for data supplied in electronic format. The recipient accepts full responsibility for verifying the accuracy and completeness of the data. The recipient releases Stantec, its officers, employees, consultants and agents, from any and all claims arising in any way from the content or provision of the data.

V:\2023\Active\2037031\60\03_data\gls_cad\gis\mxd\Appendix_Figures\Fig2_Project_Alignment_1\1x171.mxd Revised: 2020-01-07 By: chjohnson

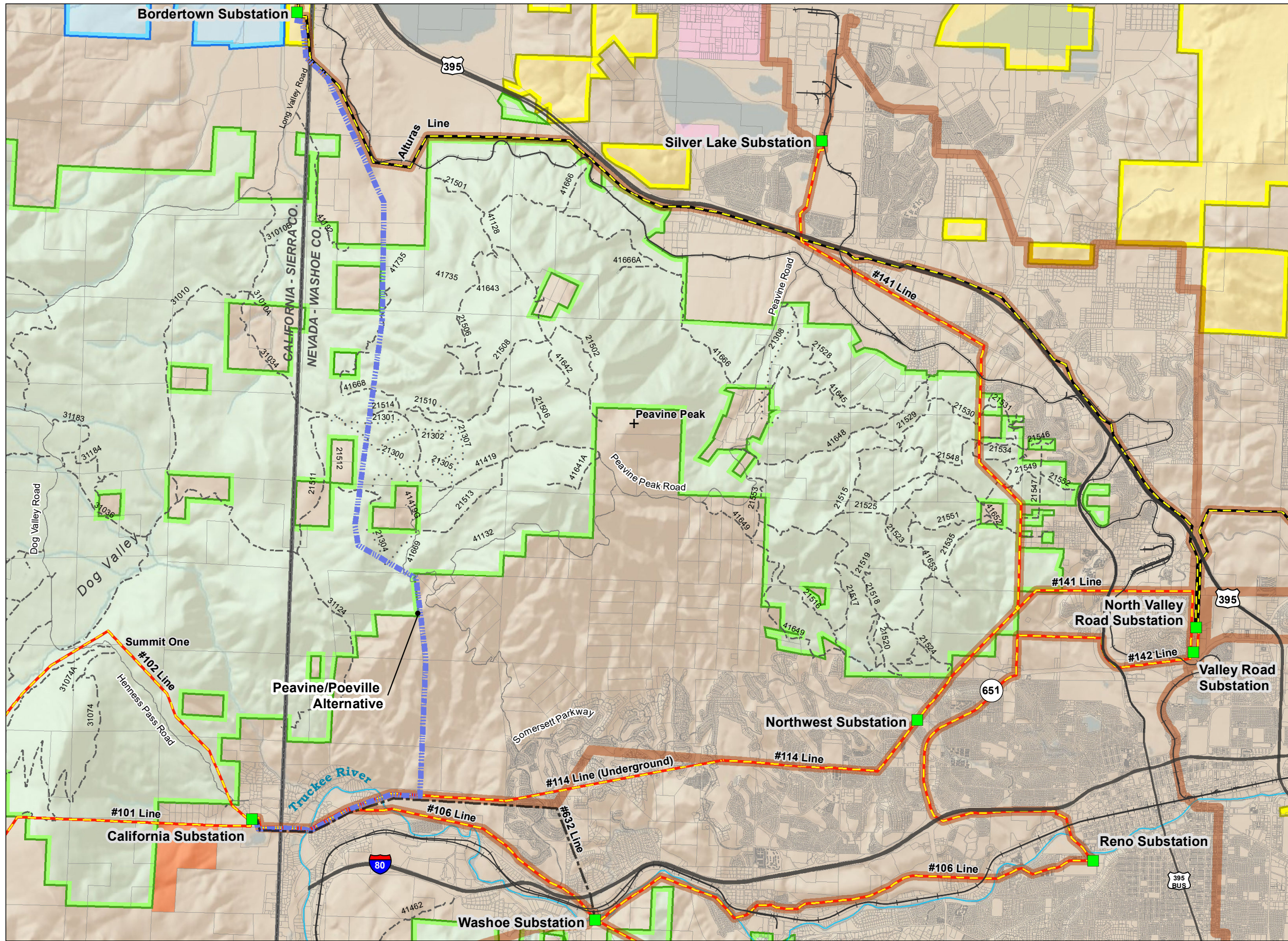

- Legend**
- Bordertown to California 120 kV Transmission Line
 - Existing Features**
 - 120 kV Transmission Line
 - 345 kV Transmission Line
 - 60 kV Transmission Line
 - Existing Transmission Line Corridors (TMRPA, 2012)
 - Substation
 - Railroads
 - NFS Roads**
 - NFS Roads
 - NFS Motorcycles Only
 - Public and Private Road
 - Land Ownership**
 - U.S. Bureau of Land Management
 - U.S. Forest Service
 - California Department of Fish & Wildlife
 - U.S. Bureau of Reclamation

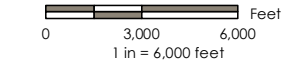

Sierra County, CA & Washoe County, NV
 NAD 1983 UTM Zone 11N

PROJECT NO: 203703160
 DRAWN BY: JT
 1ST REVIEW: CJ
 2ND REVIEW: KC
 DATE: 1/7/2020

NV Energy
 Bordertown to California 120 kV Transmission Line Construction, Operation, and Maintenance (COM) Plan

Figure 2
Project Alignment

Disclaimer: Stantec assumes no responsibility for data supplied in electronic format. The recipient accepts full responsibility for verifying the accuracy and completeness of the data. The recipient releases Stantec, its officers, employees, consultants and agents, from any and all claims arising in any way from the content or provision of the data.

Service Layer Credits: Copyright (c) 2014 Esri

V:\2037\active\203703160\03_data\gis\mxd\Pre\mxd\Bordertown_Substation_Modification_11x17L.mxd Revised: 2019-03-04 By: jhock

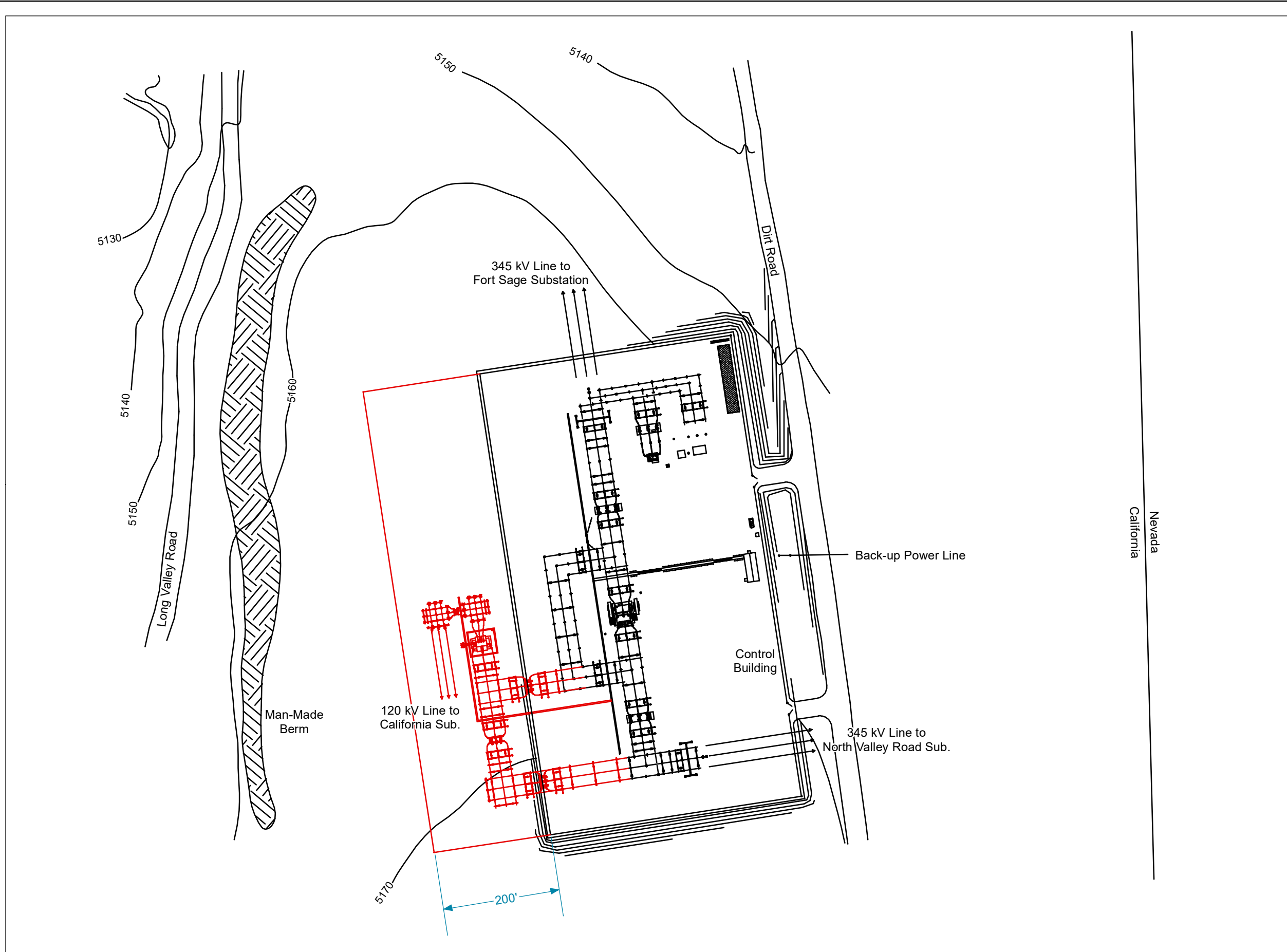

Legend

- Existing
- Proposed

Not to Scale



PROJECT NO: 203703160
 DRAWN BY: CJ
 1ST REVIEW: JT
 2ND REVIEW: KC
 DATE: 3/4/2019

NV Energy
 Bordertown to California 120 kV
 Transmission Line Construction,
 Operation, and Maintenance (COM) Plan

Figure 3
Bordertown Substation
Modification

V:\2037\active\203703160\03_cad\gib\mxd\preliminary\Figures\Figs_California_Substation_Modification_11.kxl.mxd Revised: 2019-03-04 By: jtrook

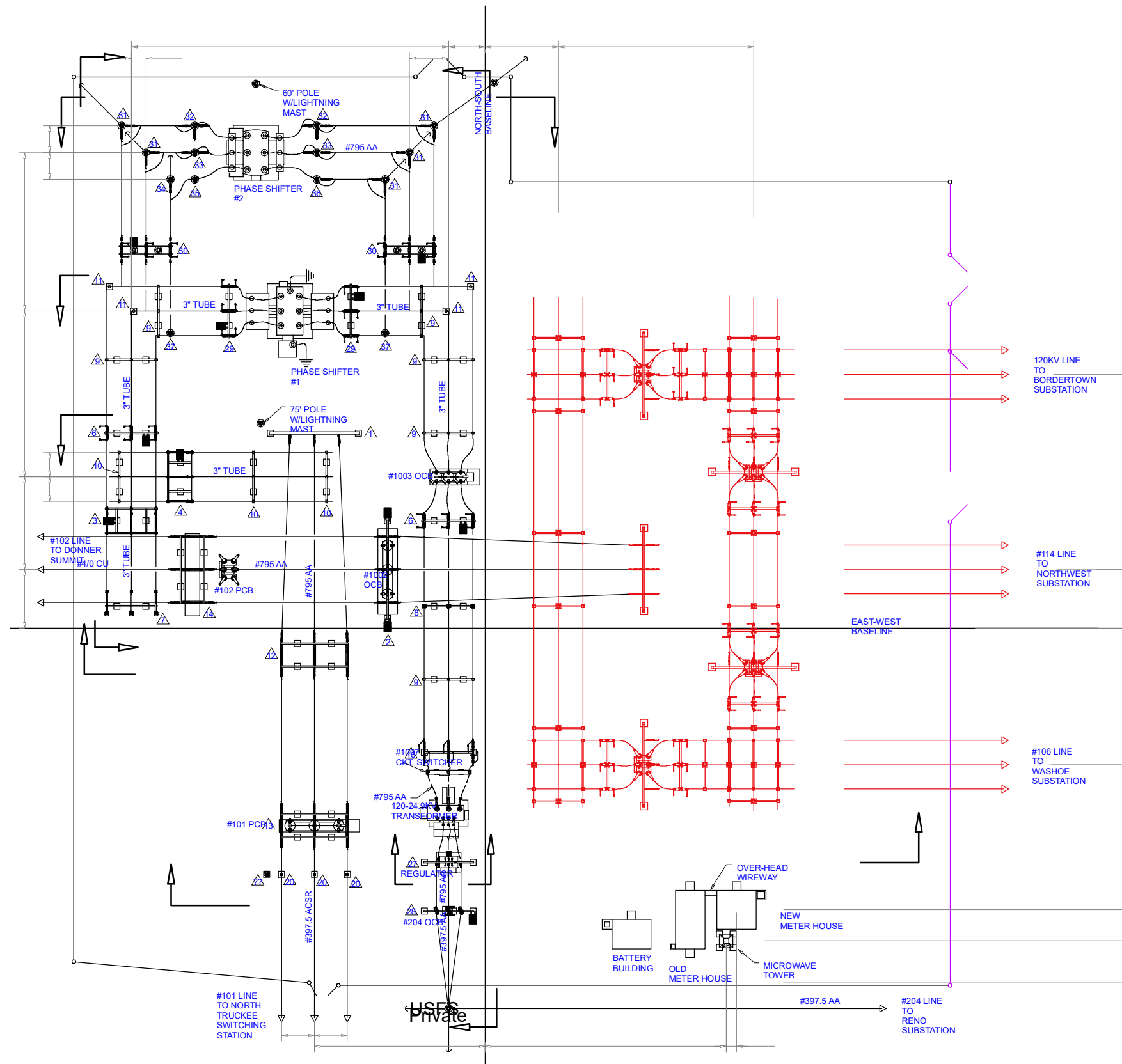

Legend

- Existing
- Addition
- Existing Fence to be Replaced

Not to Scale



PROJECT NO: 203703160
 DRAWN BY: CJ
 1ST REVIEW: JT
 2ND REVIEW: KC
 DATE: 3/4/2019

NV Energy
 Bordertown to California 120 kV
 Transmission Line Construction,
 Operation, and Maintenance (COM) Plan

Figure 4
California Substation
Modification

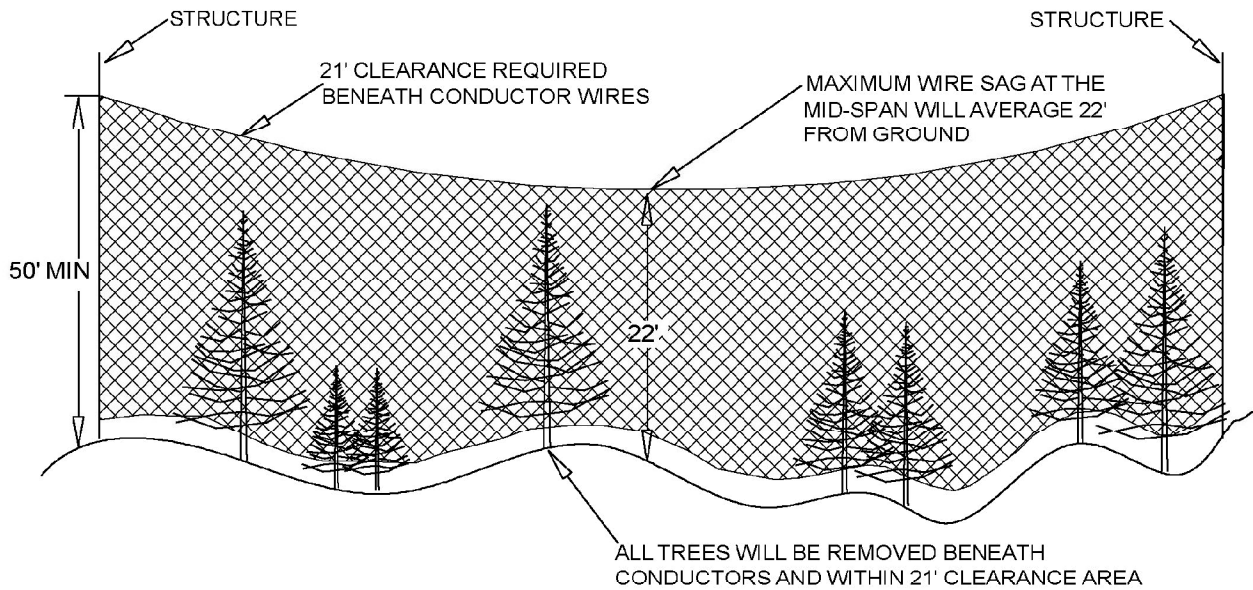

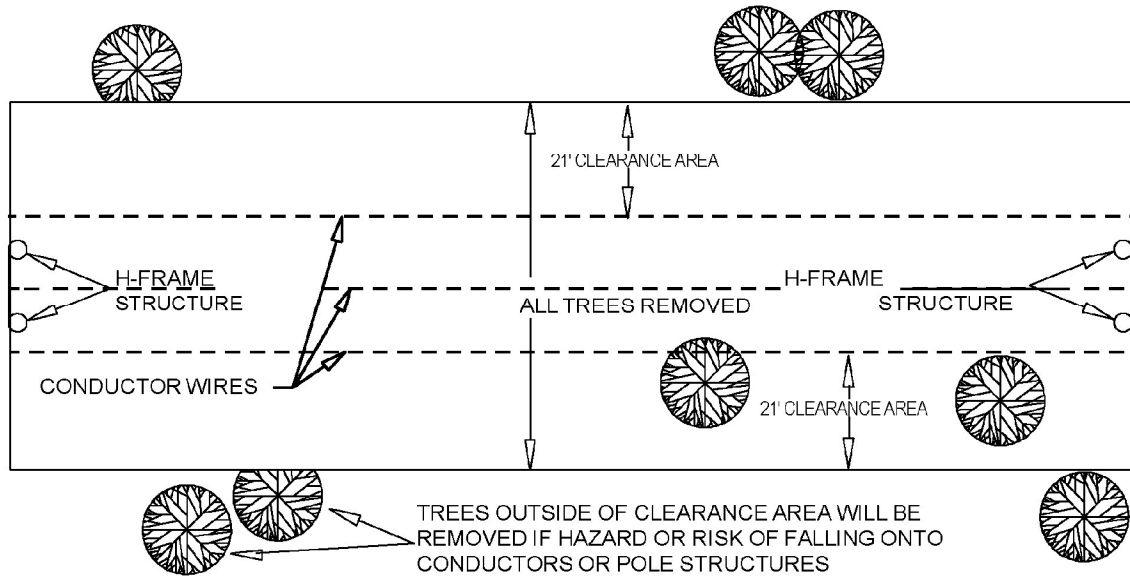

SIDE VIEW



PLAN VIEW

V:\2037\Active\203703160\03_data\gis_cad\gis\mxd\ Preliminary_Figures\Fig6_Tree_Trimming_Clearing_Distances.8x11P.mxd Revised: 2019-03-04 By: jbrook

 		
Not to Scale		
DRAWN BY: JT	1ST REVIEW: CJ	2ND REVIEW: KC
DATE: 3/4/2019		PROJECT NO: 203703160

NV Energy
 Bordertown to California 120 kV
 Transmission Line Construction,
 Operation, and Maintenance (COM) Plan

Figure 5
Tree-Trimming and
Clearance Distances

Disclaimer: Stantec assumes no responsibility for data supplied in electronic format. The recipient accepts full responsibility for verifying the accuracy and completeness of the data. The recipient releases Stantec, its officers, employees, consultants and agents, from any and all claims arising in any way from the content or provision of the data.

V:\2037\Active\203703160\03_data\gis_cad\gis\mxd\Preliminary_Figures\Fig7_Single_Pole_Structure_8x11P.mxd Revised: 2019-03-04 By: Jrook

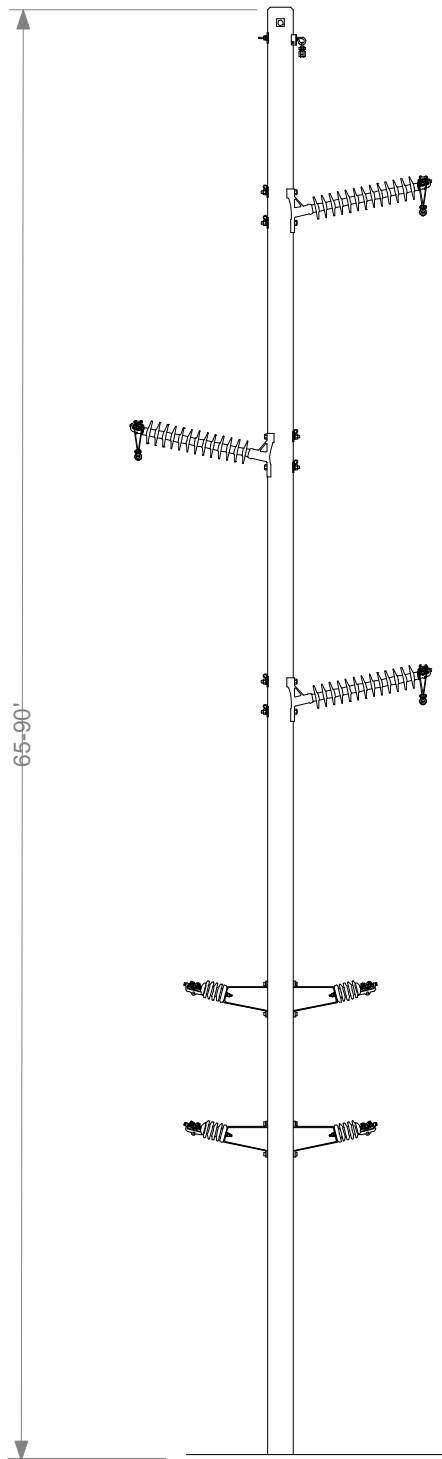

Stantec

NV Energy
Bordertown to California 120 kV
Transmission Line Construction,
Operation, and Maintenance (COM) Plan

Not to Scale

DRAWN BY: JT

1ST REVIEW: CJ

2ND REVIEW: KC

DATE: 3/4/2019

PROJECT NO: 203703160

Figure 6
Single Pole Structure

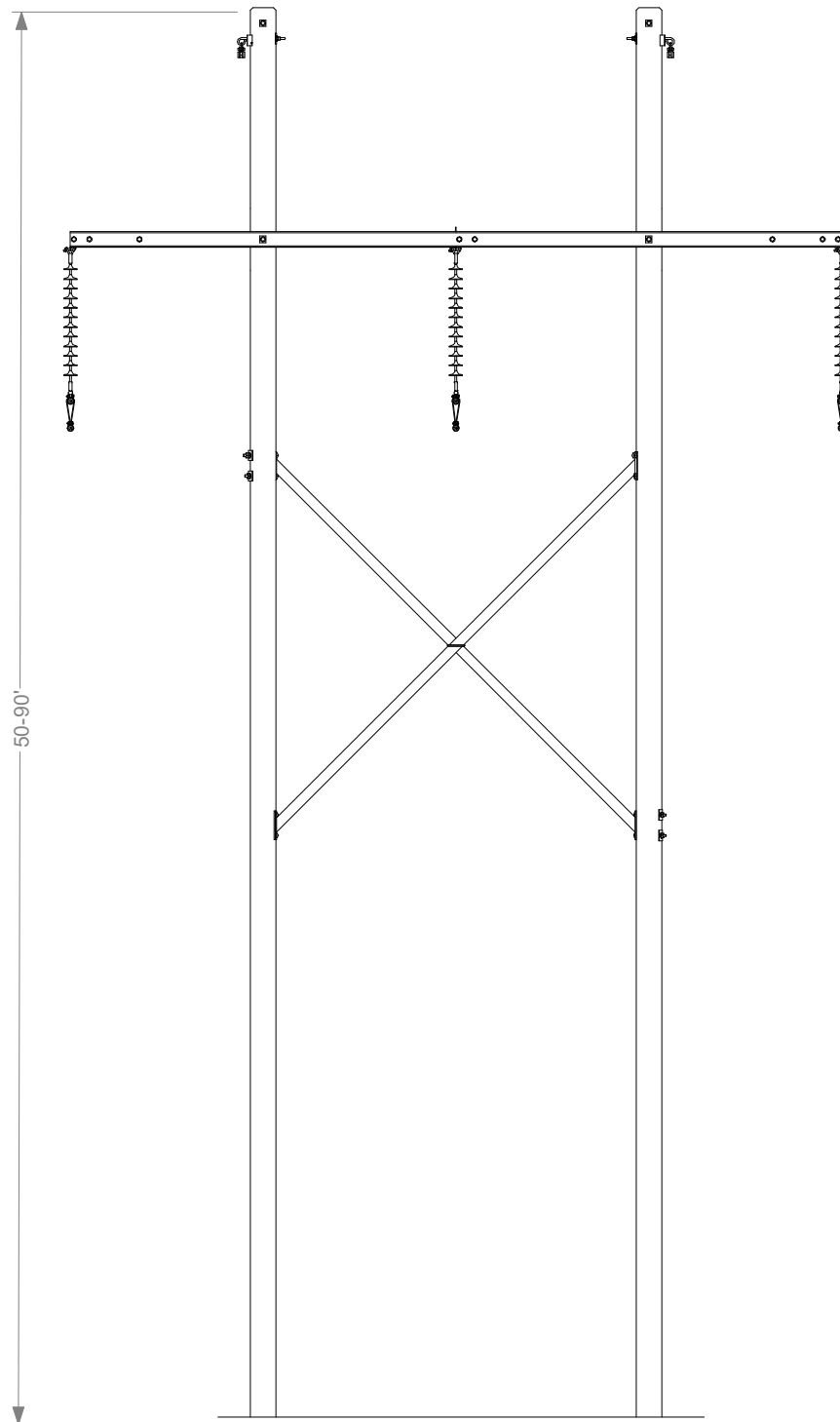

50-90'

ELEVATION

V:\2037\active\203703160\03_data\figs_cad\figs\mxd\ Preliminary_Figures\Fig8_HFrame_Structure_&11P.mxd Revised: 2019-03-04 By: jbrook



NV Energy
 Bordertown to California 120 kV
 Transmission Line Construction,
 Operation, and Maintenance (COM) Plan

Not to Scale

Figure 7
H-Frame Structure

DRAWN BY: JT

1ST REVIEW: CJ



2ND REVIEW: KC

DATE: 3/4/2019

PROJECT NO: 203703160

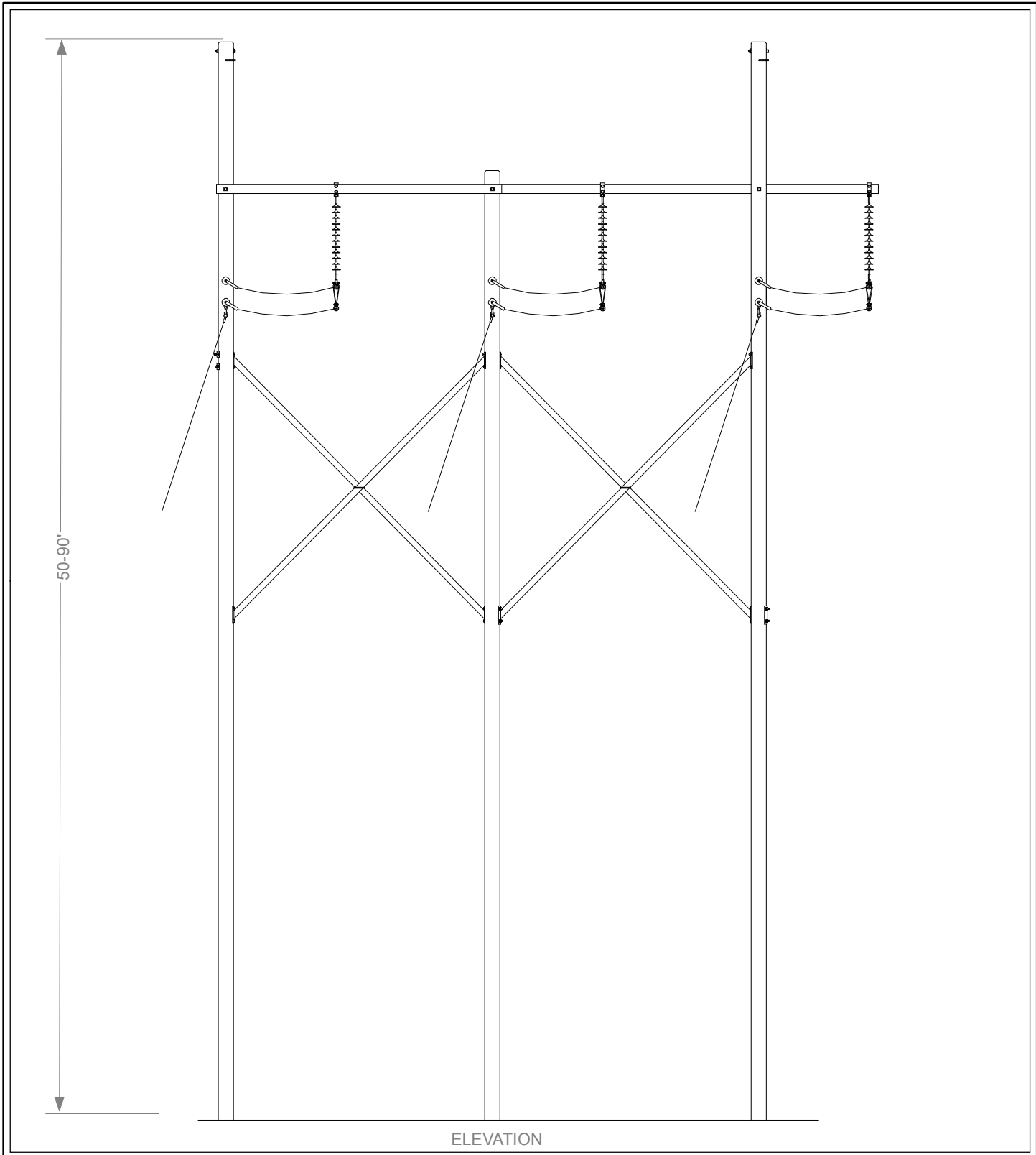
V:\2037\Active\203703160\03_data\gis_cad\gis\mxd\Preliminary_Figures\Fig9_3-pole_Dead_End_Angle_Structure_8x11P.mxd Revised: 2019-09-04 By: jhook



	 		NV Energy Bordertown to California 120 kV Transmission Line Construction, Operation, and Maintenance (COM) Plan	
	Not to Scale			
	DRAWN BY: JT	1ST REVIEW: CJ		2ND REVIEW: KC
	DATE: 3/4/2019			PROJECT NO: 203703160
			Figure 8 3-Pole Dead-end/Angle Structure	

Disclaimer: Stantec assumes no responsibility for data supplied in electronic format. The recipient accepts full responsibility for verifying the accuracy and completeness of the data. The recipient releases Stantec, its officers, employees, consultants and agents, from any and all claims arising in any way from the content or provision of the data.

APPENDIX A1

Fire Prevention and Suppression Plan

**Fire Prevention and Suppression Plan
Bordertown to California 120 kV Transmission Line
Construction, Operation, and Maintenance (COM) Plan**

Prepared for:

NV Energy
6100 Neil Road
Reno, Nevada 89511

Prepared by:

Stantec Consulting Services Inc.
6995 Sierra Center Parkway
Reno, Nevada 89511

August 2020

Table of Contents

1.0	INTRODUCTION	1
1.1	Purpose and Need	1
1.2	Regulatory Overview.....	1
2.0	RESPONSIBILITIES	2
2.1	United States Forest Service	2
2.2	Bureau of Land Management.....	2
2.3	NV Energy	2
2.4	Construction Contractor(s)' Designated Fire Marshal.....	3
2.5	Notification	3
3.0	FIRE PRECAUTION MEASURES	4
3.1	Fire restrictions	6
4.0	IN CASE OF FIRE - INITIAL RESPONSE	10
5.0	POST-FIRE REHABILITATION STRATEGIES	10

List of Tables

Table 1	Emergency Fire Contacts	4
---------	-------------------------------	---

LIST OF ABBREVIATIONS

BLM	Bureau of Land Management
CAL FIRE	California Department of Forestry and Fire Protection
COM	Construction, Operations, and Maintenance
CFR	Code of Federal Regulations
FMO	Fire Management Officer
kV	Kilovolt
Plan	Fire Prevention and Suppression Plan
Project	Bordertown to California 120 Kilovolt Transmission Line Project
ROW	Right-of-Way
U.S.	United States
USFS	United States Forest Service



1.0 INTRODUCTION

NV Energy and its contractors will construct the Bordertown to California 120 Kilovolt (kV) Transmission Line Project (Project) in compliance with all federal, state, and local regulations as well as the National Environmental Policy Act, the Environmental Impact Statement and Final Record of Decision, the United States (U.S.) Forest Service (USFS) Special Use Permit, and all other applicable permits. The Project area is in Washoe County, Nevada, and Sierra County, California, west and northwest of the city of Reno, Nevada. The northern boundary of the Project area is near Bordertown, Nevada, and U.S. Highway 395 and the southern boundary is near Interstate 80 between Verdi, Nevada, and Mogul, Nevada. The western boundary is roughly parallel with the California state line and the eastern boundary extends to the Peavine area generally east of Peavine Peak. The constructed 120 kV overhead transmission line will be approximately 11.9 miles long and will run between the existing Bordertown and California substations in Sierra County, California.

This Fire Prevention and Suppression Plan (Plan) is part of NV Energy's compliance obligation and is appended to the Construction, Operations, and Maintenance (COM) Plan. This Plan will be implemented throughout the Project, beginning with the construction period, and it details the measures to be taken during construction and operation of the Project to: 1) reduce the risk of starting a fire, and 2) suppress a fire in the event one occurs within the construction area. This Plan identifies fire-related risks inherent in this type of project and actions to reduce those risks. It describes the types of firefighting suppression equipment required during construction and the appropriate response if a fire occurs.

1.1 PURPOSE AND NEED

The risk of fire danger during construction of a transmission line is related largely to the use of vehicles and other motorized equipment operating off roadways, and the handling and use of explosive materials and flammable liquids.

The purpose of this plan is to outline responsibilities, notification procedures, fire prevention measures, fire suppression equipment, and post-fire rehabilitation strategies related to the needs of this Project. The Project will cross areas that support vegetation types that are susceptible to wildfire during dry seasons. The need is to minimize the risk of Project-related fires and, in case of fire, provide for immediate suppression within the construction area. Other plans containing information related to fires include: the Hazardous Materials Management and Spill Prevention, Control, and Countermeasure Plan (Appendix A2), the Emergency Preparedness and Response Plan (Appendix A3), and the Blasting Plan (Appendix A4).

1.2 REGULATORY OVERVIEW

This Project will be subject to state, county, and federally enforced laws, ordinances, rules, and regulations that pertain to fire prevention and suppression activities. Key local regulatory agencies include the USFS, Bureau of Land Management (BLM), Nevada Division of Forestry, California Department of Forestry and Fire Protection (CAL FIRE), Truckee Meadows Fire Protection District, and the Reno Fire Department.



2.0 RESPONSIBILITIES

2.1 UNITED STATES FOREST SERVICE

The USFS will oversee all fire control activities on their administrative unit. The designated USFS contact will discuss fire protection stipulations with the BLM and NV Energy's Project or construction manager concerning actions to be taken during fire control activities and will notify NV Energy when fire conditions warrant changes in fire plans. The designated USFS contact will designate an on-site USFS representative.

2.2 BUREAU OF LAND MANAGEMENT

The BLM Fire Management Officer (FMO) will oversee all fire control activities in their administrative unit. The FMO will discuss fire protection stipulations with the USFS and NV Energy's Project or construction manager concerning action to be taken during fire control activities and will notify NV Energy when fire conditions warrant changes in fire plans. The BLM FMO will designate the field monitor as their on-site representative.

2.3 NV ENERGY

NV Energy will be responsible for providing the necessary fire-fighting equipment for their employees and ensuring that all employees and contractors operate under the requirements of this Plan. NV Energy's Project manager will implement the following plan:

- NV Energy will designate a fire marshal from NV Energy to coordinate with the contractor(s)' designated fire marshal and with the USFS and BLM fire management personnel as necessary and who will also fulfill duties described in Section 2.4 for construction areas that are NV Energy's sole responsibility;
- If a fire starts in the Project area, initiate fire suppression activities on the Project until relieved by agency or local firefighting services;
- Comply with federal, state, and local laws, ordinances, rules, and regulations that pertain to prevention and suppression of fire activities;
- Ensure that the contractor(s)' fire marshal is performing regular fire inspections (see below) and takes appropriate protection measures in the event of non-compliance with this Plan;
- Notify the contractor(s) to stop or reduce construction activities that pose a significant fire hazard until appropriate safeguards are taken; and
- Coordinate with the USFS and BLM fire management representative regarding current fire conditions and fire safety warnings and communicate these to the contractor(s)' designated fire marshal (see below).



2.4 CONSTRUCTION CONTRACTOR(S)' DESIGNATED FIRE MARSHAL

NV Energy's prime construction contractor will designate a fire marshal who will be responsible for the following tasks:

- Conducting regular inspections of tools, equipment, and first aid kits for completeness;
- Conducting regular inspections of storage areas and practices for handling flammable fuels to confirm compliance with applicable laws and regulations;
- Posting smoking and fire rules at centrally visible locations on site;
- Coordinating initial response to contractor-caused fires within the easement/right-of-way (ROW);
- Conducting fire inspections along the easement/ROW;
- Ensuring that all construction workers and subcontractors are aware of all fire protection measures;
- Remaining on duty and on site when construction activities are in progress and during any additional periods when fire safety is an issue, or designating another individual to serve in this capacity when absent;
- Reporting all wildfires in accordance with the notification procedures described below;
- Initiating and implementing fire suppression activities until relieved by agency or local firefighting services in the event of a Project-related fire; and
- Coordinating with the NV Energy Construction manager regarding current potential fire conditions and fire safety warnings from the USFS or BLM, whichever is appropriate, and communicating these to the contractor's crews.

2.5 NOTIFICATION

The environmental field supervisor will immediately notify the USFS and/or BLM of a fire started in the Project area during construction, its location, and the corrective action taken. During operation and maintenance activities, NV Energy crews, or contract crews under its direction, will be responsible for the notification of a fire started in the Project area, its location, and the corrective action taken. Following verbal notification, NV Energy will provide written documentation. The construction contractor(s) will double-check the following emergency contact numbers for any changes prior to construction. All fires will be reported first to 911 then the Sierra Front Interagency Dispatch Center and if appropriate to the jurisdictional fire agency, regardless of size and actions taken. Table 1 provides a list of emergency fire contacts for the Project:



Table 1 Emergency Fire Contacts

CALL 911 FIRST	
Sierra Front Interagency Dispatch Center (775) 883-3535 for Emergencies (775) 883-5995 for Administration	
USFS Humboldt-Toiyabe National Forest Carson Ranger District (775) 882-2766	BLM Eagle Lake Field Office (530) 257-0456
Nevada Division of Forestry All Fires: (775) 883-3535 State Forest Fire Warden: (775) 684-2501 Eastlake-Washoe Valley Office: (775) 849-2500	CAL FIRE Headquarters: (916) 653-5123 State Fire Marshall (916) 568-3800 Nevada-Yuba-Placer Unit: (530) 823-4270
Truckee Meadows Fire Protection District Fire Chief: (775) 325-6000	Reno Fire Department Reno Fire Chief: (775) 232-0031 Administrative Offices: (775) 334-2300

3.0 FIRE PRECAUTION MEASURES

NV Energy will perform a preconstruction field review prior to commencing operations. The review will use the provisions set forth below to outline the channels of responsibility for fire prevention and suppression activities and establish an attack procedure for fires within the project area. NV Energy will cooperate with local fire prevention authorities and the USFS in eliminating hazardous fire conditions by implementing the following fire plan under the direction of the environmental field supervisor.

During operations that utilize helicopters or air support, daily communication with the Sierra Front Interagency Dispatch Center Aircraft Desk will occur. Contact information including a phone number will be provided in the event of the need to clear airspace for firefighting operations.

NV Energy and its contractors will immediately report all fires to the nearest fire suppression agency by calling 911. If a fire is unmanageable, field crews will evacuate. All fires will be reported to the Sierra Front Interagency Dispatch Center (775) 883-3535 (emergency line), regardless of size and actions taken.

When reporting a fire, the following information will be provided:

- Your Name
- Call back telephone number
- Project Name
- Location: Legal description (Township, Range, Section or Latitude/Longitude); and Descriptive location (Reference point)
- Fire Information: Including Acres, Rate of Spread and Wind Conditions



Additionally, NV Energy and its contractors will comply with the following requirements:

- a) Notify Sierra Front Interagency Dispatch Center daily by phone (775) 883-5995 (non-emergency line) with the scheduled work activities including hours of operation and request that the Fire Duty Officer is notified with this information. Obtain the daily fire danger rating for the Front Valleys and follow the required mitigation measures according to the adjective ratings in Section 3.1 of this document.
- b) At least one radio, cellular telephone, and/or satellite phone will be available to contact fire suppression agencies or the Project management team. Smoking shall not be permitted, except in a barren area or in an area cleared to mineral soil at least three feet in diameter. All burning tobacco and matches will be completely extinguished and discarded in ash trays, not on the ground.
- c) Briefing all employees on the fire precaution plan and associated requirements.
- d) If a fire does start by accident, immediate steps will be taken to extinguish it (if it is safe to do so) using available fire suppression equipment and techniques. Fire suppression activities will be initiated by NV Energy and/or its contractor(s) until relieved by agency or local firefighting services.
- e) All vehicles will contain a fire extinguisher.
- f) NV Energy and its contractors will provide continuous access to roads for emergency vehicles during construction.
- g) "NO SMOKING" signs and fire rules will be posted at construction staging areas, helicopter fly yards, and key construction sites during the fire season.
- h) The use of torches, fuses, highway flares, or other warning devices with open flames will be prohibited. NV Energy and its contractors will only use electric or battery-operated warning devices on site.
- i) No blasting will be performed without the notification of NV Energy's construction manager and/or the Project environmental manager. Blasting operations will follow the requirements described in the Blasting Plan (Appendix A4).
- j) No open burning, campfires, or barbeques will be allowed along the ROW, at construction staging areas, helicopter fly yards, substations, on access roads, or in any other Project-related construction areas.
- k) Back-pumps filled with water (two at each wood-cutting site, one at each welding site, and two at each tower installation or construction site, or any activity site at risk of igniting fires) will be supplied.



- l) Vehicles will not be driven on dry grass or brush.
- m) Proper vehicle maintenance will be implemented, including:
 - a. Securing trailer chains, ensuring they don't drag on the ground;
 - b. Checking tire pressure to avoid underinflated tires, exposed wheel rims can throw sparks;
 - c. Brakes will be properly maintained to avoid metal on metal contact.

3.1 FIRE RESTRICTIONS

If Fire Restrictions are in effect the following prohibitions will be abided by, pursuant to 36 Code of Federal Regulations (CFR) 261.50(a) and (b) until further notice unless approved in writing by the District Ranger and District Fire Staff with the Forest Supervisors approval.

- a) Building, maintaining, attending, or using a fire, campfire, or stovefire.
[36 CFR 261.52(a)]
- b) Smoking, outside an enclosed vehicle or building.
[36 CFR 261.52(d)]
- c) Welding or operating an acetylene or other torch with open flame.
[36 CFR 261.52(i)]
- d) Using an explosive.
[36 CFR 261.52(b)]
- e) No chainsaw use after 1:00 PM, when fire restrictions are in effect. If a Red Flag warning or fire weather watch is in effect, all wood cutting is prohibited until the warning is lifted.

The wildland fire danger rating system established by the USFS is designed to estimate the relative effect of weather on several aspects of fire behavior, such as spread, intensity, and ignition. The combination of these effects makes up the fire danger rating, the severity of which is as follows: Low, Medium, High, Very High, Extreme.

Low Fire Danger Rating Restrictions

All activities at the Project site will include the following safeguards and restrictions no matter the level of fire restrictions in place:

1. Except for motor trucks, truck tractors, buses and passenger vehicles equipped with a maintained muffler, equip all hydro-carbon fueled engines, both stationary and mobile, including off-highway vehicles and motorcycles, with spark arresters that meet



U.S. Forest Service Standards as specified in the Forest Service Spark Arrester Guide and maintain the spark arresters in good operating condition. The Forest Service Spark Arrester Guides are available at the https://www.fs.fed.us/t-d/programs/fire/spark_arrester_guides/.

2. Equipment service areas, parking areas and gas and oil storage areas shall be located so that there is no flammable material within a radius of at least 50 feet of these areas. Keep work areas clear of flammable material such as oily rags and waste, paper, cartons, and plastic waste and utilize proper containers for material storage. "NO SMOKING" signs will be posted in these areas at all times.
3. All stationary fuel tanks will be grounded.
4. Small mobile or stationary engine sites shall be cleared of flammable material for a radius of at least 16 feet from the engine.
5. Confine welding and grinding activity to cleared areas having a minimum radius of 10 feet measured from the place of welding or grinding. Welding or cutting activities will cease one hour before all fire response personnel leave a construction area to reduce the possibility of welding activities smoldering and starting a fire.
6. Each piece of equipment will be furnished with the following:
 - a) Each truck, personnel vehicle tractor, grader or other heavy equipment with one shovel, one axe or pulaski, and one fully charged fire extinguisher UL rated at 2-A:10-B:C, or larger
 - b) Each welder will have two shovels, one fire extinguisher and one back-pack filled with five gallons of water or other extinguishing solution with a hand pump.
 - c) Each gasoline-powered tool such as chain saws, soil augers and rock drills require two shovels and two fully charged chemical pressurized fire extinguisher. The required fire tools shall, at no time, be farther than 26 feet from the point of operation of the power tool.
 - d) Equip each mechanized machine that have hydraulic systems with at least two 4A:80-B:C fire extinguishers, or equivalent for each powered by an internal combustion engine (chipper, feller/buncher), except tractors and skidders. In addition, concentrations of wood dust and debris shall be removed from such equipment daily.
 - e) Hardhat, work gloves, and eye protection
 - f) All shovels shall be size "O" or larger and shall be not less than four feet in length.



7. Fuel service trucks will contain one 35-pound capacity fire extinguisher charged with the necessary chemicals to control electrical and fuel fires.

Moderate Fire Danger Rating Restrictions

When the fire danger rating reaches "**Moderate**" the following precautions shall be taken in addition to the conditions specified above:

1. Provide water tank truck or trailer on or in proximity to the Project area for fire control during all working hours and as specified herein.
 - a. Equip truck with fire tools (shovel, axe or pulaski's) to provide for one tool per person, two backpack five gallon water-filled tanks with pumps, and one chainsaw of 3.5 (or more) horsepower with a cutting bar of at least 20 inches in length.
 - b. In addition to being available at the work site, the truck and operator shall patrol the area of construction for at least 1 hour after shutdown.

High Fire Danger Rating Restrictions

When the fire danger rating reaches "**High**", the following precautions shall be taken in addition to the conditions specified above:

Provide water tank truck or trailer on or in proximity to the Project area for fire control during all working hours and as specified herein.

- a. Equip truck with a 500-gallon or greater tank of water with a gasoline motor powered pump and 250 feet of 3/4 inch hose on a reel with a pump capacity of 150 psi or greater and fuel sufficient for 2 hours of operation.
- b. All welding and grinding shall be discontinued except in an enclosed building or within an area cleared of all flammable material for a radius of 16 feet and must be pre-wet.
- c. No welding or grinding, unless it is in an enclosed building during the time frame designated as **Red Flag Warning**. Burning or blasting shall not be permitted. At Project access points provide a sign to notify workers of the time the restriction becomes effective.

Very High Fire Danger Rating Restrictions

When the fire danger rating reaches "**Very High**", the following precautions shall be taken in addition to the conditions specified above:



- a. Chainsaw and mastication operations shall be discontinued after 1:00 PM.
- b. All welding and grinding shall be discontinued except in an enclosed building or within an area cleared of all flammable material for a radius of 16 feet and must be pre-wet for a radius of at least 40 feet.
- c. All blasting shall be discontinued unless the area has been previously cleared from all flammable materials.
- d. Smoking will be permitted only in an enclosed vehicle equipped with an ashtray or in an enclosed building.
- e. Except in case of emergency, vehicular travel will be restricted to cleared areas or areas which have been pre-wet and are accessible by pressurized water hose or pressurized water tank.
- f. In areas not cleared for a radius of 16 feet, pre-wet the area before beginning operations. Maintain the area in a wet condition and provide one lookout with fire-fighting equipment.
- g. During the time frame designated as **Red Flag Warning**, no welding or grinding, unless it is in an enclosed building. Burning or blasting shall not be permitted. At Project access points provide a sign to notify workers of the time the restriction becomes effective.

Extreme Fire Danger Rating Restrictions

When the Fire danger Rating reaches "**Extreme**", the following precautions shall be taken in addition to the conditions specified above:

- a. A special written authorization from the District Ranger in consultation with the District Fire Management Officer must be obtained in advance of any welding, grinding, blasting or cutting metal. All other activities are prohibited.
- b. Any work that could start a fire shall require properly equipped fire personnel to be assigned to an operation for the duration of the work to provide for immediate fire response.
- c. No welding, blasting or grinding of any kind shall be permitted unless it is in an enclosed building or within an area cleared of all flammable material for a radius of 32 feet and must be pre-wet for a radius of at least 60 feet.



- d. In areas not cleared for a radius of 32 feet, pre-wet the area before beginning operations, for example but not limited to mastication or mowing. Maintain the area in a wet condition and provide a lookout with fire-fighting equipment.
- e. During the time frame designated as **Red Flag Warning**, no welding or grinding, unless it is in an enclosed building. At Project access points provide a sign to notify workers of the time the restriction becomes effective.

4.0 IN CASE OF FIRE - INITIAL RESPONSE

If a fire does start in the Project area during construction, operation, or maintenance, and if the fire is manageable, safely attempt to control it with a fire extinguisher or other available equipment.

As part of the environmental compliance training program, the contractor(s) will receive training on the following:

- Initial fire suppression techniques;
- Fire event reporting requirements;
- Methods to determine if a fire is manageable;
- Fire control measures to be implemented by field crews on site;
- When the worksite should be evacuated;
- How to respond to wildfires in the vicinity; and
- How to maintain knowledge of, and plans for, evacuation routes.

If a fire is unmanageable, field crews will evacuate and immediately call "911" or the district dispatch for the area (see emergency fire contacts listed in Table 1). All fires will be reported to the jurisdictional fire agency, regardless of size and actions taken.

5.0 POST-FIRE REHABILITATION STRATEGIES

If the cause of a fire is determined to be the result of the Project, NV Energy will implement rehabilitation measures to support the following goals:

- Restoration of high-quality wildlife habitat and various vegetation types;
- Restoration of range value;
- Suppression of invasive weeds;



- Prevention of increased fire hazard; and
- Prevention of increased erosion.

The following post-fire rehabilitation measures will be implemented by NV Energy:

After a fire has been extinguished, the burn areas will be reclaimed in accordance with agency and landowner requirements. Small fires will be revegetated to the native vegetation using appropriate seed mixtures. Larger fires may require restoration plans. Coordination with the applicable agencies would be necessary to determine requirements for each particular area, depending upon the size and location of a fire, and the location of sensitive resources. For more details, refer to the Reclamation and Habitat Restoration Plan (Appendix C3).

To prevent the spread of invasive weeds during post-fire rehabilitation, the following measures will be implemented by NV Energy and/or its contractors:

- Off-road vehicles and all-terrain vehicles will be inspected and will receive high pressure air or water cleaning on the undercarriage if necessary, with special emphasis on axles, frame, cross members, motor mounts, underneath the steps, running boards, and front bumper/brush guard assemblies;
- Clean off-road equipment (power or high-pressure cleaning) of all mud, dirt, and plant parts before moving into weed-free areas;
- NV Energy and the contractor employees working in the field will receive basic weed identification training;
- NV Energy will implement a Noxious Species Abatement Plan (Appendix C1) and a Reclamation and Habitat Restoration Plan (Appendix C3); and
- Reclamation activities will use certified weed free seed.



APPENDIX A2

Hazardous Materials Management and Spill Prevention Plan

**Hazardous Materials Management and
Spill Prevention Plan
Bordertown to California 120 kV Transmission Line
Construction, Operation, and Maintenance (COM) Plan**

Prepared for:

NV Energy
6100 Neil Road
Reno, NV 89511

Prepared by:

Stantec Consulting Services Inc.
6995 Sierra Center Parkway
Reno, NV 89511

August 2020

Table of Contents

1.0	INTRODUCTION	1
1.1	Overview of the Plan Components.....	1
1.2	Regulatory Overview.....	1
2.0	GUIDELINES FOR DEVELOPING THE HAZARDOUS MATERIALS MANAGEMENT AND SPILL PREVENTION PLAN	3
2.1	Certifications, Acknowledgements and Designation of Coordinator/Responsible Person	3
2.1.1	Certifications	3
2.1.2	Amendments	3
2.1.3	Responsible Persons.....	3
2.2	Facilities Description and Inventory of Material	4
2.2.1	Site Map.....	4
2.2.2	Inventory	4
3.0	HAZARDOUS MATERIALS MANAGEMENT	6
3.1	Overview of Hazardous Materials Proposed for Use	6
3.2	Refueling and Servicing	7
3.3	Transportation of Hazardous Materials	7
3.4	Storage of Hazardous Materials.....	7
3.4.1	Physical Storage Requirements	8
3.4.2	Container Labeling Requirements	8
3.5	Disposal of Hazardous Wastes	9
3.6	Contaminated Containers	9
3.7	Waste Oil Filters.....	10
3.8	Used Lubricating Oil.....	10
4.0	SPILL CONTROL AND COUNTERMEASURES	11
4.1	Physical and Procedural Responses Measures	11
4.1.1	On-Site Equipment	12
4.2	Employee Spill Prevention/Response Training and Education	12
5.0	NOTIFICATION AND DOCUMENTATION PROCEDURES	14
5.1	Required Notification.....	14
5.1.1	Reporting Criteria	15
5.2	Documentation.....	15
6.0	OPERATIONS AND MAINTENANCE	17
7.0	REFERENCES	17

List of Tables

Table 1	Hazardous Materials Proposed for Project Use.....	6
Table 2	Standard Spill Information Requested by Agencies.....	15

List of Figures

Figure 1	Sample Hazardous Waste Label for On-Site Storage	9
----------	--	---



List of Appendices

Appendix A Certifications, Acknowledgements, and Designation of Emergency Coordinator

LIST OF ABBREVIATIONS

BMP	Best Management Practice
CERCLA	Comprehensive Environmental Response, Compensation, and Liability Act
CFR	Code of Federal Regulations
COM	Construction, Operations, and Maintenance
EIS	Environmental Impact Statement
EPA	Environmental Protection Agency
ID	Identification
kV	Kilovolt
MSDS	Material Safety Data Sheets
NAC	Nevada Administrative Code
NDEP	Nevada Division of Environmental Protection
NRC	National Response Center
OSHA	Occupational Safety and Health Act
Plan	Hazardous Materials Management and Spill Prevention Plan
Project	Bordertown to California 120 Kilovolt Transmission Line Project
RCRA	Resource Conservation and Recovery Act
U.S.	United States
U.S. DOT	U.S. Department of Transportation
U.S.C.	United States Code
USFS	US Forest Service



1.0 INTRODUCTION

NV Energy and its contractors will construct the Bordertown to California 120 Kilovolt (kV) Transmission Line Project (Project) in compliance with all federal, state, and local regulations as well as the National Environmental Policy Act, the Environmental Impact Statement (EIS) and Final Record of Decision, the United States (U.S.) Forest Service (USFS) Special Use Permit, and all other applicable permits. The project area is in Washoe County, Nevada, and Sierra County, California, west and northwest of the city of Reno, Nevada. The northern boundary of the Project area is near Bordertown, Nevada, and U.S. Highway 395 and the southern boundary is near Interstate 80 between Verdi, Nevada, and Mogul, Nevada. The western boundary is roughly parallel with the California state line and the eastern boundary extends to the Peavine area generally east of Peavine Peak. The constructed 120 kV overhead transmission line will be approximately 11.9 miles long and will run between the existing Bordertown and California substations in Sierra County, California.

This Hazardous Materials Management and Spill Prevention Plan (Plan) is part of NV Energy's compliance obligation and is appended to the Construction, Operations, and Maintenance (COM) Plan. The intent of this Plan is to reduce the risks associated with the use, storage, transportation, production, and disposal of hazardous materials (including hazardous substances and wastes). This plan also outlines the required spill prevention, response, and clean-up procedures for the Project.

1.1 OVERVIEW OF THE PLAN COMPONENTS

The goals of this plan are to: (1) minimize the potential for a spill of fuel or other hazardous substance; (2) contain any spillage to the smallest possible area; and (3) protect areas that are environmentally sensitive. This plan includes the following components:

- Guidelines for developing this Plan;
- Spill prevention procedures related to the transportation, storage, and disposal of hazardous materials;
- Spill control, response, and clean-up methods;
- An overview of the notification and documentation procedures to be followed in the event of a spill; and
- Vehicle refueling and servicing procedures.

In general, hazardous materials, hazardous wastes, and clean-up equipment will be stored at construction staging areas.

1.2 REGULATORY OVERVIEW

The leading legislation pertaining to hazardous materials includes the Comprehensive Environmental Response, Compensation, and Liability Act (CERCLA), the Resource Conservation and Recovery Act (RCRA), the Clean Air Act, and the Clean Water Act.



Numerous other federal, state, and local regulations also govern the use, storage, transport, production, and disposal of hazardous materials. Some of the key requirements of these laws are outlined in:

- Occupational Safety and Health Act (OSHA), 29 United States Code (U.S.C.) § 651 et seq.;
- Clean Water Act, 33 U.S.C. § 1251 et seq.;
- Safe Drinking Water Act, 42 U.S.C. § 300f et seq.;
- Clean Air Act, 42 U.S.C. § 7401 et seq.;
- Toxic Substances Control Act, 15 U.S.C. § 2601 et seq.;
- CERCLA, 42 U.S.C. § 9601 et seq.;
- RCRA, 42 U.S.C. § 6901 et seq.;
- Hazardous Materials Transportation Act, 49 U.S.C. 5101 § et seq.; and
- Hazardous Materials, The Nevada Administrative Code (NAC) 445A.345 - 348.

Person(s) responsible for handling hazardous materials for this Project will be trained in the proper use/management of the materials and should be familiar with all applicable laws, policies, procedures, and best management practices (BMPs) related to them.



2.0 GUIDELINES FOR DEVELOPING THE HAZARDOUS MATERIALS MANAGEMENT AND SPILL PREVENTION PLAN

2.1 CERTIFICATIONS, ACKNOWLEDGEMENTS AND DESIGNATION OF COORDINATOR/RESPONSIBLE PERSON

2.1.1 Certifications

The construction contractor(s) shall certify that all of the information provided in this Plan is accurate and complete to the best of their knowledge (as detailed in Appendix A, Table A1). The construction contractor(s) shall also certify that they are committed to implementing the Plan as written.

2.1.2 Amendments

In completing this certification, the construction contractor(s) shall agree to make all necessary and appropriate amendments to the plan and submit any and all such amendments to NV Energy and the appropriate federal, state, and county (if required) authorities within six months following preparation of the amendment. Examples of changes that require Plan amendments include, but are not limited to:

- Commissioning or decommissioning containers;
- Replacement, reconstruction, or movement of containers;
- Reconstruction, replacement, or installation of piping systems;
- Construction or demolition that might alter secondary containment structures;
- Changes of product or service; and
- Revision of standard operation or maintenance procedures at the facility.

2.1.3 Responsible Persons

The construction contractor(s) shall identify a primary responsible coordinator for hazardous materials management and emergency response (Appendix A, Table A3). Two alternative emergency response coordinators shall also be identified. Business, residential, and cellular telephone numbers shall be provided for all three persons as necessary to allow for contact on a 24-hour basis. Primary and alternate emergency response coordinators shall be knowledgeable of the chemicals and processes involved in the construction contractor's operation. They shall have full access to the staging areas, including locked areas, and must have the authority to commit company resources. They shall also have stop task authority in case of non-compliance or environmental danger.



2.2 FACILITIES DESCRIPTION AND INVENTORY OF MATERIAL

2.2.1 Site Map

The construction contractor(s) shall complete Table A1 in Appendix A. The construction contractor(s) shall also provide a site map/facility map for their staging areas indicating storage and safety precautions for hazardous materials and hazardous wastes. The construction contractor(s)' site map shall, at a minimum, indicate the following:

- Orientation and scale;
- Total land area in square-feet;
- Access and egress points;
- Buildings and/or temporary trailers;
- Parking areas;
- Adjacent land uses (if business, indicate business name);
- Surrounding roads, storm drains and waterways (including streams and wetlands);
- Locations of hazardous materials and hazardous waste storage;
- Underground and aboveground tanks;
- Containment or diversion structures (dikes, berms, retention ponds);
- Shutoff valves and/or circuit breakers;
- Location of emergency response materials and equipment;
- Location of material safety data sheets (MSDS) and Hazardous Materials and Spill Prevention Plan; and
- Location of emergency assembly area.

All maps must be provided on standard 8½-by-11-inch paper.

2.2.2 Inventory

The construction contractor(s) shall provide a complete inventory of all hazardous materials that meet reportable quantities. A complete list of hazardous substances and reportable quantities are defined under 40 Code of Federal Regulations (CFR) 302.4. All inventory forms shall be provided to NV Energy by the construction contractor(s) as a part of this Plan.

Reportable quantities for acutely hazardous materials and/or wastes may differ from the reportable quantities identified under 40 CFR 302. The construction contractor(s) shall be



responsible for consulting with the relevant agencies if they handle acutely hazardous materials as defined under 40 CFR 260.10.



3.0 HAZARDOUS MATERIALS MANAGEMENT

Construction, operation, and maintenance of the Project will require the use of certain potentially hazardous materials such as fuels, oils, explosives, and herbicides. By definition, hazardous materials (substances and wastes) have the potential to pose a significant threat to human health and the environment based upon their quantity, concentration, or chemical composition. When stored, used, transported, and disposed of properly as described below, the risks associated with these materials can be reduced substantially.

3.1 OVERVIEW OF HAZARDOUS MATERIALS PROPOSED FOR USE

The following Project-specific measures pertain to all vehicle refueling and servicing activities as well as the storage, transportation, production, and disposal of hazardous materials/wastes. These measures are intended to prevent the discharge of fuels, oils, gasoline and other harmful substances to waterways, groundwater aquifers, and/or other sensitive resource areas during Project construction and maintenance.

Hazardous materials used during Project construction may include petroleum products such as gasoline, hydraulic fluid, lubricating oils and solvents, and other substances. Some of these materials will be used in relatively large quantities at the staging areas and in rare instances on the right-of-way to operate and maintain equipment during construction. Explosives may be used for blasting rock where needed to install power pole structures. The use of explosives for this Project is discussed in detail in the Blasting Plan (Appendix A4 of the COM Plan).

Smaller quantities of other materials such as pesticides and fertilizers, paints, and chemicals, will be used during Project operation and maintenance. Table 1 provides a list of materials anticipated for use during construction, operation, and maintenance of the Project. NV Energy will update the inventory of hazardous materials used/stored on-site as needed throughout the life of the Project. NV Energy has a well-developed Hazardous Material Program in place and works to use non-hazardous substances in routine construction and maintenance activities to the extent possible.

Table 1 Hazardous Materials Proposed for Project Use

Hazardous Materials	
2-Cycle Oil	Lubricating Grease
ABC Fire Extinguisher	Mastic Coating
Acetylene Gas	North Wasp and Hornet Spray (1,1,1-Trichloroethane)
Air tool Oil	Oxygen8\78
Antifreeze	Paint
Automatic Transmission Fluid	Paint Thinner
Battery Acid	Petroleum Products
Bee Bop Insect Killer	Prestone II Antifreeze
Canned Spray Paint	Puncture Seal Tire Inflator
Chain Lubricant (Methylene Chloride)	Safety Fuses
Connector Grease	Safety Solvent
Contact Cleaner 2000	Starter Fluid



Hazardous Materials	
Eye Glass Cleaner (Methylene Chloride)	Trichloroethane
Gas Treatment	Wagner Brake Fluid
Gasoline	WD-40
Insulating and Hydraulic Oil	

3.2 REFUELING AND SERVICING

Construction vehicles (trucks, bulldozers, etc.), and equipment (pumps, generators, etc.) generally will be fueled and serviced in designated upland areas at 300 feet away from perennial streams and 150 feet of all other streams. Refueling locations generally should be flat to minimize the chance of a spilled substance reaching a stream. In most cases, rubber-tired vehicles will be refueled and serviced at local gas stations or staging areas. Tracked vehicles typically will be refueled and serviced at designated staging areas.

All construction vehicles will be maintained in accordance with the manufacturers' recommendations. All vehicles will be inspected for leaks prior to entering the jobsite. All discovered leaks will be contained with a bucket or absorbent materials until repairs can be made.

3.3 TRANSPORTATION OF HAZARDOUS MATERIALS

Procedures for loading and transporting fuels and other hazardous materials will meet the minimum requirements established by the U.S. Department of Transportation (DOT) and other pertinent regulations (49 CFR 100-185). Prior to transporting hazardous materials, appropriate shipping papers shall be completed. Vehicles carrying hazardous materials will be equipped with shovels, barrier tape, absorbent socks or pads, four- to six-millimeter plastic bags or heavy-duty trash bags, personal protective clothing (e.g., gloves), and spill pads to contain a small spill should one occur during transport. In addition, vehicles transporting such materials will be properly signed (placard) and/or marked. Prior to transporting hazardous materials, vehicles will be inspected for leakage and other potential safety problems. The construction contractor(s) will ensure that vehicle drivers are trained to properly respond to and report spills, leakage, and/or accidents involving hazardous materials (Section 4.2).

All hazardous materials used for the Project will be properly containerized and labeled at all times, including during transportation. Smaller containers will be used on-site to transport needed amounts of hazardous materials to a specific location. Transfer of materials from large to small containers will not be done by hand pouring but will be accomplished using appropriate equipment including pumps, hoses, and safety equipment. These smaller ("service") containers will also be clearly labeled. Labeling will be in accordance with 40 CFR 262. Special provisions apply to the transportation of explosives and are further discussed in the Blasting Plan (Appendix A4).

3.4 STORAGE OF HAZARDOUS MATERIALS

Hazardous materials will be stored only in designated staging areas. Long-term equipment staging and storage areas will not be located on National Forest System lands (Design Feature GP 6 from the Project EIS and further described in Section 3.2 of the COM Plan). In addition, construction equipment staging areas, and storage of equipment fuels will not be located within



300 feet of perennial streams or within 150 feet of intermittent and ephemeral streams. Staging areas and fuel storage will also not be located within 150 feet of wetlands or other water feature (Design feature WA 3 from the Project EIS and described in Section 3.2 of the COM Plan).

Any hazardous materials such as fuel, lubricants, and solvents, would be handled and stored in accordance with applicable regulations, including 40 CFR 262.

3.4.1 Physical Storage Requirements

- **Storage Containers:** Containers shall be compatible with the wastes stored. If the container is damaged or leaks, the waste must be transferred to a container in good condition. The construction contractor(s) shall inspect containers at least weekly to discover any leaks in the containers or the containment systems (Appendix A, Table A4). Containers used for transportation must comply with the U.S. DOT requirements.
- **Incompatible Wastes:** Wastes that are incompatible with other wastes shall not be placed in the same container or in an unwashed container that previously held an incompatible material.
- **Ignitable or Reactive Wastes:** Wastes that may ignite or are reactive must be located at least 50 feet from the material yard's property line. "NO SMOKING" signs shall be conspicuously placed wherever there is a hazard from ignitable or reactive waste.
- **Container Management:** Containers holding hazardous waste shall be kept closed during transfer and storage, except when it is necessary to add or remove waste.
- **Secondary Containment:** Secondary containment for bulk containers and oil filled equipment will consist of bermed or diked areas that are lined and capable of holding 110 percent of the volume of the stored material and shall be provided for fuel and oil tanks stored on-site, as needed.
- **Security:** Hazardous materials will be stored in secure areas to prevent damage, vandalism, or theft. All storage containers shall remain sealed when not in use and storage areas shall be secured (gated, locked, and/or guarded) at night and/or during non-construction periods.
- **Explosives:** Storage of explosives is discussed in Appendix A4—Blasting Plan.

3.4.2 Container Labeling Requirements

The construction contractor(s) shall comply with the following labeling requirements for any container (including tanks) used on-site to store accumulated hazardous wastes. Figure 1 shows an example of a hazardous waste label for on-site storage. The containers shall be labeled with the information below and as required in 40 CFR 262:

- The words: "Hazardous Waste";
- Generator's name and address;
- The accumulation start date and/or the date the 90-day storage period began;



- The composition and physical state of the wastes; and
- Warning words indicating the particular hazards of the waste, such as: flammable, corrosive or reactive.

Figure 1 Sample Hazardous Waste Label for On-Site Storage

HAZARDOUS WASTE	
Contents:	_____
Physical State (gas, liquid, solid):	_____
Accumulation Start Date:	_____
Hazards:	_____
Name and Address of Generator:	_____
Contact Person:	_____
Telephone:	_____
HANDLE WITH CARE!	
CONTAINS HAZARDOUS OR TOXIC WASTES	

3.5 DISPOSAL OF HAZARDOUS WASTES

All wastes generated, including trash, sanitary waste, scraps, salvage materials, hazardous materials, and petroleum products will be disposed of in accordance with applicable local, state, and federal regulations. This includes hazardous wastes, which will be collected regularly and disposed of in accordance with all applicable laws. The construction contractor(s) shall determine details on the proper handling and disposal of hazardous waste and shall assign responsibility to specific individuals prior to construction of the Project.

Hazardous wastes typically include used oil, used oil filters, used gasoline containers, spent batteries, and other items. Every effort will be made to minimize the production of hazardous waste during the Project. NV Energy maintains a list of products and wastes that it recycles. This list shall be provided to the construction contractor(s) prior to construction of the Project.

Any generator of hazardous waste (except households) must apply for an Environmental Protection Agency (EPA) Identification (ID) Number. A generator can store hazardous wastes on-site for a period of up to 90 days without having to obtain a permit as a storage facility. The ID number is needed to complete the Uniform Hazardous Waste Manifest to ship wastes off-site.

3.6 CONTAMINATED CONTAINERS

Containers that once held hazardous substances as products or which held hazardous wastes must be considered as potential hazardous wastes due to the possible presence of residual hazardous contents. Regulations specify an essentially empty container and certain handling



requirements for the empty container, for the container to be handled as a non-hazardous waste, as listed below.

- The containers must be empty, which means as much of the contents has been removed as possible so that none will pour out in any orientation.
- If the empty containers are less than five gallons, they may be disposed of as a non-hazardous solid waste or scrapped.
- If the empty containers are greater than five gallons, they must be handled in the following manner:
 - Returned to the vendor for re-use;
 - Sent to a drum recycler for reconditioning; or
 - Used or recycled on-site.

All these actions must occur within one year of the container being emptied.

3.7 WASTE OIL FILTERS

Used, metal canister oil filters can be managed as non-hazardous wastes if:

- They are thoroughly drained of “free flowing” oil (oil exiting drop-by-drop is not considered “free flowing”);
- The filters are accumulated, stored, and transferred in a closed, rainproof container; and
- The filters are transferred for purposes of recycling.

3.8 USED LUBRICATING OIL

Used lubricating oil is defined as:

- Any oil that has been refined from crude oil, and has been used, and as a result of use, has been contaminated with physical or chemical impurities.
- Any oil that has been refined from crude oil and, as a consequence of extended storage, spillage, or contamination with non-hazardous impurities such as dirt, rags, and water, is no longer useful to the original purchaser.
- Spent lubricating fluids that have been removed from a bus, truck, automobile, or heavy equipment.

4.0 SPILL CONTROL AND COUNTERMEASURES

This section describes measures that are intended to prevent the spill of hazardous materials during normal Project construction, operation, and maintenance activities. Table A2 (Appendix A) should be filled out by the construction contractor(s) to identify all sources of potential spills, including tank overflow, rupture or leakage for the Project.

However, not all potential spill situations can be foreseen. The physical and procedural steps to be taken in the event of a spill are detailed in Section 4.1. In general, NV Energy's construction contractor(s) will oversee all clean-up activities including providing necessary materials and labor, and performing all reporting and documentation as required. Notification and documentation of spills is discussed in greater detail in Section 5.0.

4.1 PHYSICAL AND PROCEDURAL RESPONSES MEASURES

Physical response actions are intended to ensure that all spills are promptly and thoroughly cleaned up. However, the first priority in responding to any spill is personal and public safety. Construction personnel will be notified of evacuation procedures to be used in the event of a spill emergency, including evacuation routes. In general, the first person on the scene will:

- Attempt to identify the source, composition, and hazard of the spill;
- Notify appropriately trained personnel immediately;
- Isolate and stop the spill if possible and begin clean-up, if it is safe;
- Initiate reporting actions; and
- Initiate evacuation of the area, if necessary.

Persons should only attempt to clean-up or control a spill if they have received proper training and possess the appropriate protective clothing and clean-up materials. Untrained individuals should notify the appropriate response personnel. In addition to these general guidelines, persons responding to spills will consult the Emergency Preparedness and Response Plan (Appendix A3 of the COM Plan) and the U.S. DOT Emergency Response Guidebook (USDOT 2016) (to be maintained by the construction contractor(s) on site during all construction activities), which outlines physical response guides for hazardous materials spills. A list of hazardous materials that may be used during Project construction are detailed in Table 1.

In general, expert advice will be sought to properly clean-up major spills. For spills on land, berms will be constructed to contain the spilled material and prevent migration of hazardous materials toward waterways. Dry materials will not be cleaned up with water or buried. Contaminated soils will be collected using appropriate machinery, stored in suitable containers, and properly disposed of in appropriately designated areas off-site. After contaminated soil is recovered, all machinery utilized will be decontaminated, and recovered soil will be treated as hazardous waste (see Section 3.5). Contaminated clean-up materials (absorbent pads, etc.) and vegetation will be disposed of in a similar manner. For major spills, clean-up will be verified by sampling and laboratory analysis.



4.1.1 On-Site Equipment

The following equipment will be maintained on-site at each material yard, staging area, and substation site (in at least two spill kits [55-gallon drums]) for use in clean-up situations:

- Shovels;
- Absorbent pads/materials;
- Personal protective gear;
- Medical first-aid supplies;
- Bung wrench (non-sparking);
- Phone list with emergency contact numbers;
- Storage containers; and
- Communications equipment.

In addition, radios or other communication equipment will be maintained in construction vehicles and other easily accessible locations.

4.2 EMPLOYEE SPILL PREVENTION/RESPONSE TRAINING AND EDUCATION

The prime construction contractor(s) and subcontractors shall provide spill prevention and response training to appropriate construction personnel (refer to OSHA requirements in Nevada [29 CFR 1910.1200]). Persons accountable for carrying out the procedures specified herein will be designated prior to construction and informed of their specific duties and responsibilities with respect to environmental compliance and hazardous materials. The training shall inform appropriate personnel of site-specific environmental compliance procedures. At a minimum, this training shall include the following:

- An overview of regulatory requirements;
- Methods for the safe handling/storage of hazardous materials;
- Spill prevention procedures;
- Emergency response procedures;
- Use of personal protective equipment;
- Use of spill clean-up equipment;
- Procedures for coordinating with emergency response teams;
- Procedures for notifying agencies;



- Procedures for documenting spills; and
- Identification of sites/areas requiring special treatment, if any.

5.0 NOTIFICATION AND DOCUMENTATION PROCEDURES

Notification and documentation procedures for spills that occur during Project construction, operation, or maintenance will conform to applicable federal, state, and local laws. Adherence to such procedures will be the top priority once initial safety and spill response actions have been taken. The following sections describe the notification and documentation procedures and should be implemented in conjunction with the response procedures listed in other sections of this Plan.

5.1 REQUIRED NOTIFICATION

Notification will begin as soon as possible after discovery of a spill. The individual who discovers the spill will contact the Environmental Field Supervisor. If the Environmental Field Supervisor determines that the spill may seriously threaten human health or the environment, he/she will orally report the discharge as soon as possible, but no later than 24 hours from the time they become aware of the circumstances, as directed below. An online form to report the spill must be submitted to the Nevada Division of Environmental Protection (NDEP) within one working day. Prior to initiating notification, the Environmental Field Supervisor (or individual initiating notification) should obtain as much information as possible. Table 2 provides standard information requested by agencies.

The following mandatory notifications will be made by the Environmental Field Supervisor. Select and notify the appropriate government agency(ies) based on geographic location of the spill site.

- NDEP, in-state (888) 331-6337 or out-of-state (775) 687-9485.
- If spill threatens human health, call the Nevada Highway Patrol Headquarters Dispatch at (775) 687-5300.
- California Governor's Office of Emergency Services State Warning Center at (800) 852-7550.
- Sierra County, California Office of Emergency Services at (530) 289-2850.
- National Response Center (NRC) (800) 424-8802. The NRC should be notified if a spill is a listed RCRA substance and of a reportable quantity, or if waters of the U.S. are impacted.

The construction contractor(s) will verify and update these emergency phone numbers before and during construction. The construction contractor(s)' foreman (or other person in charge) will notify the on-site Environmental Field Supervisor or the Environmental Field Coordinator of all spills or potential spills within construction areas. In addition, he/she will notify NV Energy's Construction manager so that the NV Energy Corporate Emergency Operations Center may be activated if necessary (Appendix A3).

When a spill poses a direct and immediate threat to health and safety and/or property, the landowners potentially affected by a spill will be notified directly by NV Energy. Immediate notification of landowners is required for all situations in which the spill poses a direct and immediate threat to health and safety and/or property.



Table 2 Standard Spill Information Requested by Agencies

<p>When notifying a regulatory agency, the following information should be provided:</p> <ul style="list-style-type: none"><input type="checkbox"/> Current threats to human health and safety, include known injuries, if any;<input type="checkbox"/> Spill location, including landmarks and nearest access route;<input type="checkbox"/> Reporter's name and phone number;<input type="checkbox"/> Time the spill occurred;<input type="checkbox"/> Type and estimated amount of hazardous materials involved;<input type="checkbox"/> Potential threat to property and environmental resources, especially streams and waterways; and<input type="checkbox"/> Status of response actions.
--

Failure to report a spill could result in substantial penalties of \$25,000 per day (Nevada Revised Statutes 445A.700). On-site personnel should always consult the Environmental Field Supervisor to clarify regulatory requirements.

5.1.1 Reporting Criteria

The prime construction contractor(s) and subcontractors are required to report all hazardous materials spills to the Environmental Field Supervisor, who will determine if the spill meets the following criteria for immediate agency notification. The NDEP must be notified as soon as possible but no later than the end of the first working day of the release. The following reporting criteria apply for petroleum products:

- Greater than 25 gallons of petroleum products released to land surface;
- Any petroleum release to groundwater;
- Greater than three cubic yards of petroleum contaminated soil discovered during any subsurface activity; and
- Any release to surface water.

5.2 DOCUMENTATION

The construction contractor(s) will maintain records for all spills. State and federal agencies that have been verbally notified of a spill will be informed in writing within one day for state agencies and within 30 to 60 days for federal agencies.

The construction contractor(s) shall record spill information in a daily log. The following is a list of items that should be included in the daily log (as appropriate, based on the spill incident):

- Time and date of each log entry;
- Name of individual recording log entry;
- List of all agencies notified, including name of individual notified, time and date;
- Type and amount of material spill;



- Resources affected by spill;
- List of response actions taken, including relative success;
- Copies of letters, permits, or other communications received from government agencies throughout the duration of the spill response;
- Copies of all outgoing correspondence related to the spill; and
- Photographs of the response effort (and surrounding baseline photographs, if relevant).

Maintaining detailed and organized records during a spill incident is an important and prudent task. An individual construction contractor(s) representative should be designated to manage the records for an incident. If extensive spill response and clean-up operations are required, the construction contractor(s) may choose to assign a bookkeeper to assist in the documentation process. An on-site bookkeeper will track and manage all expenditures (i.e., equipment, personnel/labor hours, and associated resources) and will help supplement the information provided in the daily log book.

6.0 OPERATIONS AND MAINTENANCE

During the Project's operation and maintenance phase, NV Energy will ensure that its facilities, personnel, and contractors comply with federal, state and local laws regulating the use, storage, transport and disposal of hazardous materials and adhere to required emergency response and clean-up procedures in the event of a hazardous spill.

7.0 REFERENCES

U.S. Department of Transportation (USDOT). 2016. Emergency Response Guidebook: Guidebook Intended for use by First Responders during the Initial Phase of a Transportation Incident Involving Dangerous Goods/Hazardous Materials.

APPENDIX A

**Certifications, Acknowledgements, and Designation of
Emergency Coordinator**

The construction contractor(s) responsible for managing the material yards shall complete and submit the following information listed in Tables A1 through A4.

Table A1 Certifications, Acknowledgments and Designation of Emergency Coordinator

General Information			
Business Name:	_____		
Facility Street Address:	_____		
City:	_____		
County:	_____		
Zip Code:	_____		
Phone:	_____		
Mailing Address (if different):	_____		
City:	_____		
County:	_____		
Zip Code:	_____		
Emergency Coordinator			
Primary Emergency Coordinator: ()	()	()	_____
	Business Phone	24-hour Phone	Cellular Phone
1st Alternate: ()	()	()	_____
	Business Phone	24-hour Phone	Cellular Phone
2nd Alternate: ()	()	()	_____
	Business Phone	24-hour Phone	Cellular Phone
Owner/Operator Certification			
I certify under penalty of law that I have personally examined and am familiar with the information submitted in the Hazardous Materials Management and Spill Prevention Plan and believe the information is true, accurate, and complete.			
_____	_____	_____	
Print Name of Owner/Operator	Signature of Owner/Operator	Date	

The construction contractor(s) shall identify all sources of potential spills, including tank overflow, rupture or leakage.

Table A2 Spill Prevention, Control, and Countermeasure

Material:	_____	Total Quantity:	_____
	Location of Use:	_____	_____
	Potential Direction of Flow:	_____	_____
	Maximum Rate of Flow:	_____	_____
Structures or Equipment to Contain Spill:	_____	_____	_____
	_____	_____	_____
	_____	_____	_____
Material:	_____	Total Quantity:	_____
	Location of Use:	_____	_____
	Potential Direction of Flow:	_____	_____
	Maximum Rate of Flow:	_____	_____
Structures or Equipment to Contain Spill:	_____	_____	_____
	_____	_____	_____
	_____	_____	_____
Material:	_____	Total Quantity:	_____
	Location of Use:	_____	_____
	Potential Direction of Flow:	_____	_____
	Maximum Rate of Flow:	_____	_____
Structures or Equipment to Contain Spill:	_____	_____	_____
	_____	_____	_____
	_____	_____	_____
Material:	_____	Total Quantity:	_____
	Location of Use:	_____	_____
	Potential Direction of Flow:	_____	_____
	Maximum Rate of Flow:	_____	_____
Structures or Equipment to Contain Spill:	_____	_____	_____
	_____	_____	_____
	_____	_____	_____

Table A3 Emergency Checklist

<u>DIAL 911 FOR EMERGENCY RESPONSE</u>		
Emergency Coordinator:	()	()
Name	(Day Phone)	(Night Phone)
First Alternate:	()	()
Name	(Day Phone)	(Night Phone)
Second Alternate:	()	()
Name	(Day Phone)	(Night Phone)
Contractor	Telephone Number	
Address		
Emergency Numbers		
Emergency Response: (Ambulance, Fire, Police, Sheriff, Nevada Highway Patrol) 911		
Sierra County Sheriff: (530) 289-2850	Washoe County Sheriff: (775) 328-3001	
Poison Control Center: (800) 222-1222		
Nearest Hospitals (2):	Saint Mary's Regional Medical Center	Phone: (775) 770-3000
	Renown Regional Medical Center	Phone: (775) 982-4100
Cleanup Contractor		Phone: _____
Other (specify)		Phone: _____
Other (specify)		Phone: _____
Agency Notifications		
Nevada Division of Emergency Management	Phone: (775) 687-0400	
Nevada Division of Environmental Protection	Phone: (775) 687-9485	
California Governor's Office of Emergency Services State Warning Center	Phone: (800) 852-7550	
Sierra County, California Office of Emergency Services:	Phone: (530) 289-2850	
Washoe County, Nevada Risk Management Division:	Phone: (775) 328-2665	
National Response Center	Phone: (800) 424-8802	

Note: The construction contractor(s) shall verify and update the emergency numbers on this page before and during Project construction.

Table A4 Weekly Hazardous Materials/Waste Inspection Log

<p>For each item listed below, the construction contractor(s) shall indicate whether existing conditions are acceptable (A) or unacceptable (U). Resolution of all unacceptable conditions must be documented. The construction contractor(s) shall inspect all storage facilities on a regular basis, but not less than weekly. The construction contractor(s) shall keep records of all inspections on file.</p>	
<p>I. Storage Areas for Fuels, Lubricants and Chemicals</p>	
<p>General (A/U)</p>	
<input type="checkbox"/>	Material yard and storage areas secured.
<input type="checkbox"/>	National Fire Protection Association symbol posted in storage area or at material yard entrance.
<input type="checkbox"/>	Storage areas properly prepared and signed.
<input type="checkbox"/>	No evidence of spilled or leaking materials.
<input type="checkbox"/>	Incompatible materials separated.
<input type="checkbox"/>	All containers labeled properly.
<input type="checkbox"/>	All containers securely closed.
<input type="checkbox"/>	All containers upright.
<input type="checkbox"/>	No evidence of container bulging, damage, rust or corrosion.
<input type="checkbox"/>	Material Safety Data Sheets available.
<input type="checkbox"/>	Hazardous Materials Management and Spill Prevention Plan available.
<p>Secondary Containment Areas (A/U)</p>	
<input type="checkbox"/>	Containment berm intact and capable of holding 110% of material stored.
<input type="checkbox"/>	Lining intact.
<input type="checkbox"/>	No materials overhanging berms.
<input type="checkbox"/>	No materials stored on berms.
<input type="checkbox"/>	No flammable materials used for berms.
<p>Compressed Gases (A/U)</p>	
<input type="checkbox"/>	Cylinders labeled with contents.
<input type="checkbox"/>	Cylinders secured from falling.
<input type="checkbox"/>	Oxygen stored at least 25 feet away from fuel.
<input type="checkbox"/>	Cylinders in bulk storage are separated from incompatible materials by fire barriers or by appropriate distance.

II. Hazardous Waste Management

Waste Container Storage (A/U)

- No evidence of spilled or leaking wastes.
- Adequate secondary containment for all wastes.
- Separate containers for each waste stream (e.g., no piles).
- Waste area not adjacent to combustibles or compressed gases.
- All containers securely closed.
- Bungs secured tightly.
- Open-top drum hoops secured.
- All containers upright.
- No evidence of container bulging, corrosion.
- No severe container damage or rust.
- Containers are compatible with waste (e.g., plastic liner for corrosives, metal liner for solvents).
- No smoking and general danger/warning signs posted.

Waste Container Labeling (A/U)

- Containers properly labeled.
- Name, address and EPA ID number or ID Number listed.
- Accumulation start date listed.
- Storage start date listed.
- Chemical and physical composition of waste listed.
- Hazardous properties listed.

Nonhazardous Waste Areas (A/U)

- No litter in material yard.
- No hazardous wastes with trash (e.g., contaminated soil, oily rags, or other oily materials).
- Empty oil and aerosol containers for disposal as non-hazardous waste are completely emptied.

III. Emergency Response Equipment (A/U)

_____ Shovels.

_____ Absorbent material.

_____ Personal protective equipment (Tyvek suit, gloves, goggles and booties, as appropriate).

_____ Fire-fighting equipment.

_____ First aid supplies (e.g., medical supplies, squeeze bottle eye wash).

_____ Communication equipment.

_____ Bung wrench (non-sparking).

IV. Corrective Actions Taken

(Required for all unacceptable conditions)

Date: _____

Company (print): _____

Inspected by (print): _____

Signature: _____

APPENDIX A3

Emergency Preparedness and Response Plan

Emergency Preparedness and Response Plan Bordertown to California 120 kV Transmission Line Construction, Operation, and Maintenance (COM) Plan

Prepared for:

NV Energy
6100 Neil Road
Reno, NV 89511

Prepared by:

Stantec Consulting Services Inc.
6995 Sierra Center Parkway
Reno, NV 89511

August 2020

Table of Contents

- 1.0 INTRODUCTION..... 1**
 - 1.1 Purpose 1
 - 1.2 Regulatory Overview..... 1
- 2.0 NV ENERGY’S EMERGENCY CHAIN OF COMMAND 3**
- 3.0 RESPONSE COORDINATION..... 3**
- 4.0 EMERGENCY COMMUNICATIONS 6**
 - 4.1 Communications Diagrams 6
 - 4.2 Emergency Contact List..... 7
- 5.0 HAZARD IDENTIFICATIONS AND KEY RESPONSE CRITERIA 9**
 - 5.1 Earthquake 10
 - 5.2 Wildland Fire..... 10
 - 5.3 Traffic Corridor Disruption 12
- 6.0 EMERGENCY CONTACTS..... 13**

List of Figures

- Figure 1 Control Center Diagram..... 5
- Figure 2 Communications Protocol for Events Managed Without Additional Resources and Communications 6
- Figure 3 Communications Protocol for Events Managed With Additional Resources and Coordination 7

List of Tables

- Table 1 Emergency Contact List..... 13

List of Appendices

- Appendix A Hospitals Directions
- Appendix B NV Energy’s COVID-19 Response Plan
- Appendix C NV Energy’s Wildland Fire Plan

LIST OF ABBREVIATIONS

CEOC	Corporate Emergency Operations Center
COM	Construction, Operations, and Maintenance
kV	Kilovolt
NFS	National Forest System
Plan	Emergency Preparedness and Response Plan
Project	Bordertown to California 120 Kilovolt Transmission Line Project
U.S.	United States
USFS	United States Forest Service



1.0 INTRODUCTION

NV Energy and its contractors will construct the Bordertown to California 120 Kilovolt (kV) Transmission Line Project (Project) in compliance with all federal, state, and local regulations as well as the National Environmental Policy Act, the Environmental Impact Statement and Final Record of Decision, the United States (U.S.) Forest Service (USFS) Special Use Permit, and all other applicable permits. The Project area is in Washoe County, Nevada, and Sierra County, California, west and northwest of the city of Reno, Nevada. The northern boundary of the Project area is near Bordertown, Nevada, and U.S. Highway 395 and the southern boundary is near Interstate 80 between Verdi, Nevada, and Mogul, Nevada. The western boundary is roughly parallel with the California state line and the eastern boundary extends to the Peavine area generally east of Peavine Peak. The constructed 120 kV overhead transmission line will be approximately 11.9 miles long and will run between the existing Bordertown and California substations in Sierra County, California.

This Emergency Preparedness and Response Plan (Plan) is part of NV Energy's compliance obligation and is appended to the Construction, Operations, and Maintenance (COM) Plan. It is intended to provide an overview of NV Energy's methods of emergency management and the existing support structure, chain of command, communication plans, and focus awareness for significant hazards specific to the construction of the Project. More specific emergency procedures for fire, hazardous materials, and blasting are included in Appendices A1, A2, and A4, respectively.

The following NV Energy plans contain greater detail on NV Energy policy and instructions on how to handle specific situations. Due to the nature of the contents of these plans, they will only be available upon request from NV Energy.

- Corporate Emergency Response Plan (March 2018)
- Wildland Fire Plan (February 2019 – Appendix C)
- Gas Operations Emergency Plan (March 2015)

1.1 PURPOSE

The purpose of this Emergency Preparedness and Response Plan is to provide clear procedures and information that will enable NV Energy's Project team, contractors, other environmental inspectors, and agency monitors to prepare for and effectively respond to emergency situations. The primary objective of this Plan is to prevent adverse impacts to human health and safety, property, and the environment that could potentially result from the construction, operation and maintenance of the Project.

1.2 REGULATORY OVERVIEW

Health and safety guidelines related to high-voltage transmission lines are provided in a number of sources, including the National Electric Safety Code, American National Standards Institute,



American Medical Association Council on Scientific Affairs, American Conference of Governmental Industrial Hygienists, various state regulations, and other organizations. The Occupational Safety and Health Administration also provides regulations for construction activities.

2.0 NV ENERGY'S EMERGENCY CHAIN OF COMMAND

NV Energy is responsible for the effective response to any emergency situation or event related to the construction, operation, and maintenance of the Project. In order to ensure a coordinated and responsible corporate response, the following chain of command will be adhered to.

Control Center(s): Any NV Energy team leader, area manager, Project or plant superintendent or their alternates can activate their own organization to the level of support required to respond to any level event.

Coordination Center(s): Any NV Energy director, manager or alternate with responsibilities to support operations level control centers has the authority to activate coordination center resources to the level necessary to respond to control center(s) or emergency event needs.

Corporate Emergency Operations Center (CEOC): Only the NV Energy director of CEOC, vice president of distribution services or their alternates may authorize the activation of the CEOC. This activation will also engage the executive Policy Team to respond to the emergency or situation.

Considerations: The level of activation and participation necessary to respond to specific situations are dependent upon the following considerations:

- Type of event (natural, environmental, supply, external forces);
- Severity and geographic area (multiple or combination of events);
- Anticipated duration;
- Multi-division/discipline response required; and
- External agency coordination.

In the event of an emergency, NV Energy's construction contractor(s), subcontractors, any field inspectors, line inspectors, maintenance crews, agency monitors, or other persons should contact the NV Energy Project manager or construction supervisor as soon as possible. These individuals will then initiate NV Energy's emergency chain of command as described above.

3.0 RESPONSE COORDINATION

The amount of resources and coordination required to respond to a specific hazard or emergency event is determined by type, severity, location and duration of the event. Most events require managing at the field operations level and will require increasing resource requirements to match the severity and duration of the event. NV Energy's emergency management organization is designed to provide increasing levels of resources and coordination necessary to support

immediate or escalating emergency events. There are three levels of activation for emergency/disaster response, as listed below and shown in Figure 1.

- **Activation Level 1:** Emergencies and service interruptions that can be restored with resources under the jurisdiction of NV Energy's Project control center are managed locally. The control center will provide incident command and resource allocation for emergency response at the field operations level. The control center will respond to minor to moderate incidents/emergencies including events that escalate into Levels 2 and 3.
- **Activation Level 2:** Moderate to major incidents are managed by activation of a Coordination Center that will provide resource, information, and coordination support to the Control Center.
- **Activation Level 3:** Disaster or major emergency requiring a corporate response. Activation of the Policy Team and CEOC in response to an event will provide policy direction, strategic planning, coordination of internal and external resources, and assume internal communication and coordination and public information responsibilities.

Figure 1 Control Center Diagram

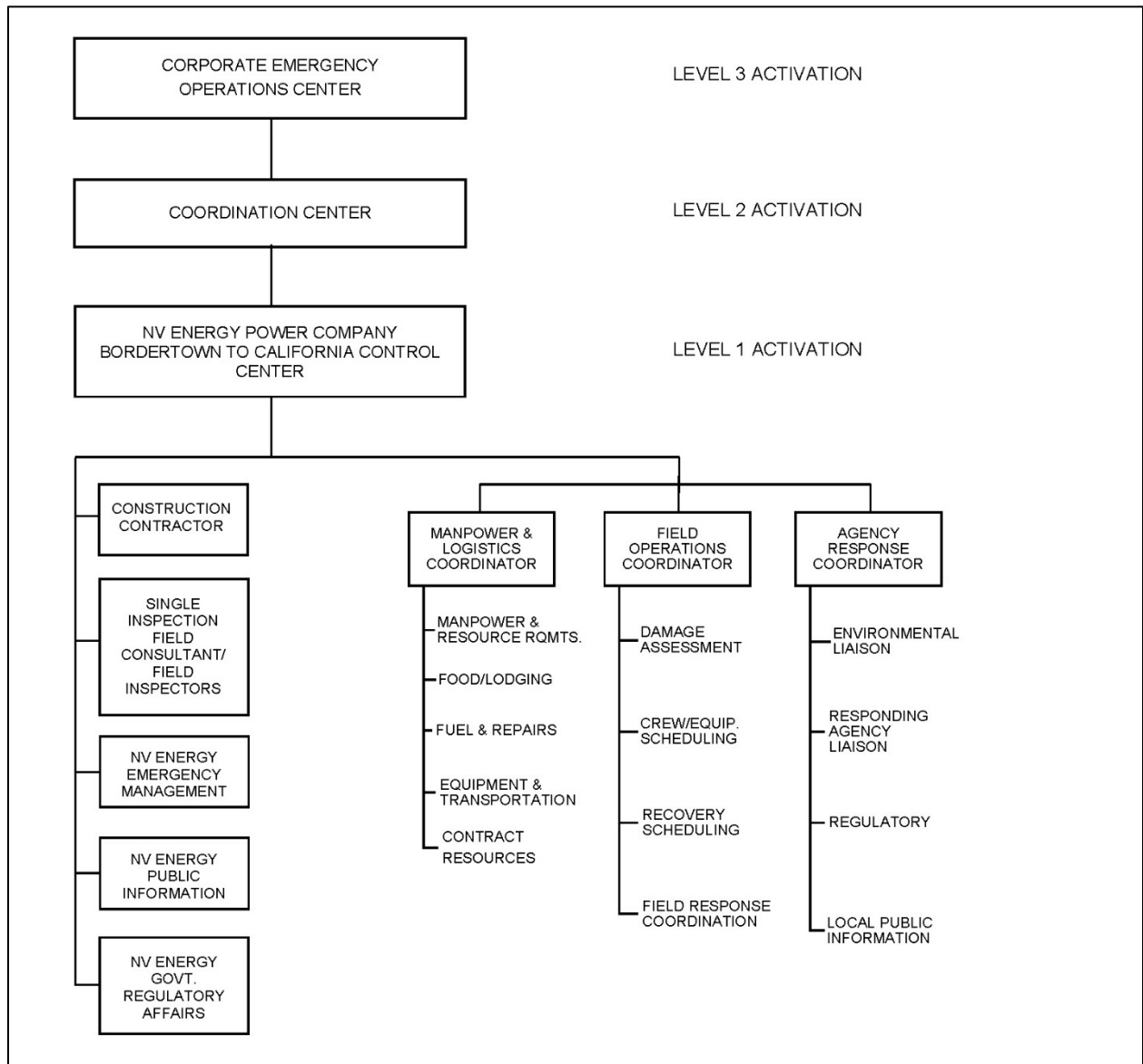

4.0 EMERGENCY COMMUNICATIONS

Effective communication and exchange of information is essential in every emergency response. Misdirected, incorrect, or untimely information can be detrimental and even increase the threat to life or property. As an emergency event escalates, the rapid increase of information creates chaos and confusion. The following sections provide simple communication diagrams which can help to alleviate this situation.

4.1 COMMUNICATIONS DIAGRAMS

The following diagrams (Figures 2 and 3) are intended to provide a representative communications protocol when responding to various emergency situations. The diagrams are for general guidance and may not address unique situations that could arise with this Project. These diagrams should be modified to represent the actual Project conditions and team structures and can be utilized in the emergency response training at the start of the Project.

Figure 2 shows normal communication links during the construction phase of the Project. This protocol should effectively manage emergency situations up to a Level 2 activation. This would include the following: local injury or life-threatening activities, low to moderate events such as fire, flash flood, severe storm, environmental or transportation accidents.

Figure 2 Communications Protocol for Events Managed Without Additional Resources and Communications

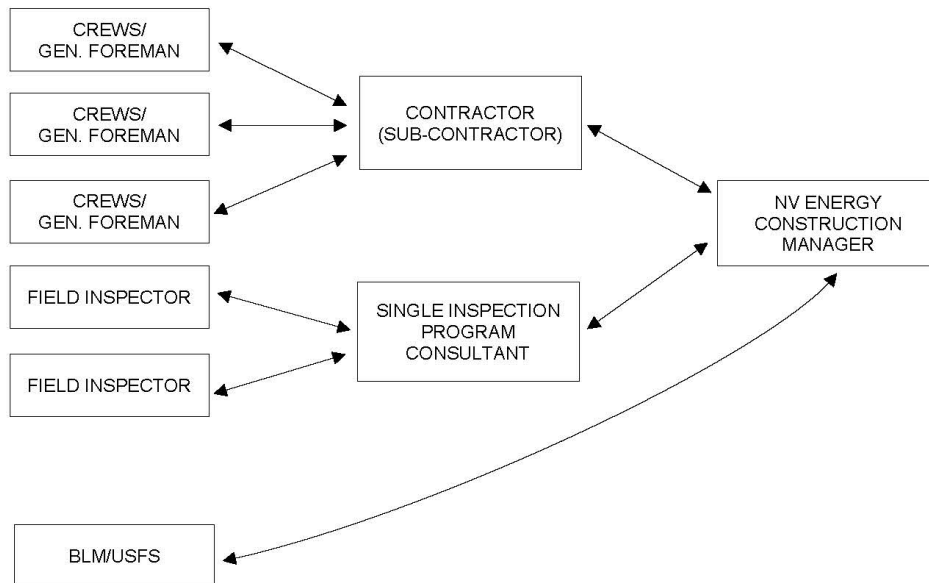

Figure 3 shows modified communication links between construction contractors, NV Energy's construction manager, and NV Energy's Control Center. The escalation of an emergency event requires additional resources, information and coordination and, therefore, certain reporting relationships will change.

The normal Project communication (inside rectangle) remains essentially unchanged except: 1) the field level Incident Command for emergency response will remain with field operations of the Project management team, and 2) the normal reporting of government agency inspectors will likely be coordinated through their respective state or regional offices or with the Nevada Division of Emergency Management and California Office of Emergency Services.

The activation of the Control Center allows the construction manager to channel resource and information needs without duplication or confusion. It also provides for inter-agency coordination at the local, state, or federal level allowing the construction manager to focus on effective field response.

Since the function and activities of the Control Center do not change with the activation of the Coordination Center or CEOC, this model can effectively manage any emergency situation up to a Level 3 activation. This would include moderate through catastrophic events.

Figure 3 Communications Protocol for Events Managed with Additional Resources and Coordination

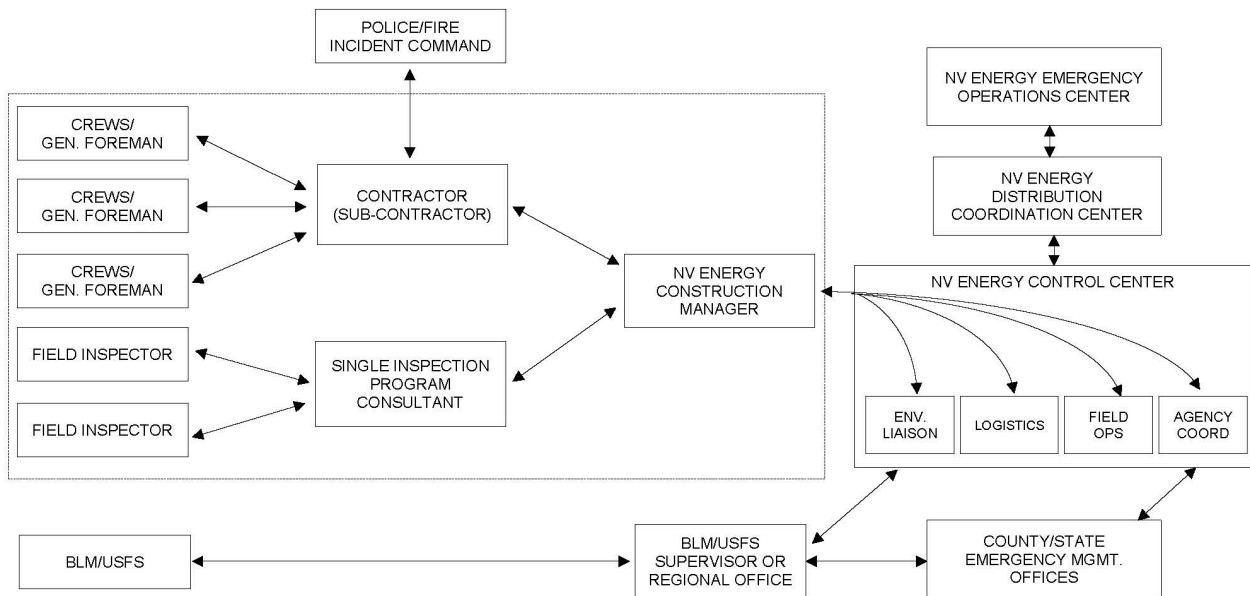

4.2 EMERGENCY CONTACT LIST

In case of emergency, call 911 first. Additional emergency contacts are listed below in Section 6.0 and should be called as appropriate depending on the situation (e.g., fire, injury, etc.). Further guidance on emergency response, notification and reporting protocols are included in the Fire Prevention and Suppression Plan (Appendix A1), the Hazardous Materials Management and Spill Prevention, Control, and Countermeasure Plan (Appendix A2), the Blasting Plan (Appendix A4), and other appendices.

The emergency contact list shall be verified and updated throughout the Project operations by NV Energy and/or the construction contractor(s) to ensure accurate contact information. The emergency contact list is also included in the COM Plan.

5.0 HAZARD IDENTIFICATIONS AND KEY RESPONSE CRITERIA

The construction corridor for the Project possesses a myriad of potential hazards or threats on both a local and regional scale. The most effective response to any situation is awareness of the hazard, its potential effects and consequences, and a good understanding of the resources and actions necessary to respond. It would be unreasonable to list all the potential hazards and detail each response. Responses to different events may vary as the event evolves, but response methods and responsibilities described in this plan are essentially unchanged.

Effective emergency response training is based on plausible emergency scenarios, and then developing the understanding, elements and actions necessary to respond. Highly visible scenarios, such as injury and rescue situations, severe weather, and hazardous materials response are mandatory training for all major projects. However, the following are a few less likely, yet plausible, scenarios related to the Project that should also be utilized in emergency response training.

There are several scenarios that can be developed involving the construction and operation of a project of this scope. Only three will be discussed in this plan:

- Earthquake;
- Wildland fires; and
- Traffic corridor disruption.

NV Energy's COVID-19 response plan is included in Appendix B of this document. The plan represents the most up-to-date plan based on guidance from the U.S. Center for Disease Control and Nevada Occupational Safety and Health Administration.

For any instances where, once operating, the transmission line must be de-energized to protect human life and property, NV Energy's headquarters in Reno must be contacted at (775) 834-4100 and informed of the specific situation and location of the problem. The transmission line can be remotely de-energized from NV Energy's Reno headquarters.

5.1 EARTHQUAKE

- Hazard:** Earthquake
The Project will be constructed in eastern California and western Nevada crossing several mountain slopes where Quaternary faults have been mapped. The line is within a few hundred feet of the Peavine Peak fault zone, about one mile from the Upper Long Valley Fault, and passes through or very near to an unnamed fault west of Peavine Peak.
- Severity:** Relatively few earthquakes greater than 5.0 (Richter Scale) have been recorded in the local Project region. However, a magnitude 5.1 earthquake occurred between Reno and Verdi in 2008, and three other earthquakes with magnitudes between 5.1 and 5.9 have occurred within about 30 miles of the Project.
- Assumptions:** The Project area has the potential for earthquake-related ground shaking of between about 0.4 and 0.8 peak acceleration, expressed as a fraction of standard gravity (with a one in 50 chance of being exceeded over a period of 50 years).
- Consequences:**
- Assume severe shaking with effect to high profile equipment such as cranes, backhoes, etc.
 - Injury—minor to life threatening. The greatest hazard areas are structure erection areas and travel in landslide areas.
 - Environmental, biological hazards, and hazardous materials spills.
- Key Response:** Immediate:
- Look–Duck–Cover–Hold, immediate personal safety.
 - Immediate area hazard identification, remove hazards and establish safe zones.
 - Aftershock awareness, potential consequences of second and third aftershocks.
 - Rescue of victims, co-workers.
 - Activate emergency response activities, i.e., control center.
 - Assist local and regional emergency response agencies.
- Secondary:
- Damage assessment—local structural (buildings, safety zones)
 - Damage assessment—Project-wide for injury, mortality.
 - Damage assessment—equipment and materials.
 - Provide vital services and establish infrastructure recovery activities.
- Intermediate to Long-Term:
- Recovery planning.
 - Impact analysis.

5.2 WILDLAND FIRE

Further guidance is provided in the Fire Prevention and Suppression Plan (Appendix A1).



- Hazard:** Wildland Fire
The Project will be constructed in eastern California and western Nevada where fire potential and hazards have a moderate to a very high risk typically due to fire and weather conditions. Fire season for this region runs from May to October.
- Severity:** Assume fire season similar to the past six years, the fuels will be heavy, and burning index will be high. Fire danger as part of the construction process will be very dependent on weather and fuels in the construction area. There are multiple ignition sources that may or may not be related to Project construction. Fire behavior over the past few years has become extreme with rapid rate of fire spreading and difficult fire control efforts. Potential for fire hazard is very high, and potential for injury, entrapment of crews is also of extreme concern.
- Assumptions:** Advanced planning and the contractor's fire marshal position will target fire safety, communication, coordination and response by all members of the Project. Fire danger and warnings, fuels, burning index, weather and other indices will be monitored and communicated during the fire season. Fire prevention, fire safety and fire suppression training will be implemented before and during fire season.
- Consequences:**
- Life safety and injury concerns.
 - Property loss and damage.
 - Environmental and ecological concerns.
- Key Response:** Immediate:
- Life safety measures and evacuation of area.
 - Contact fire agencies and Project management.
 - Immediate fire suppression activities as appropriate.
 - Lookouts, communication, escape routes, safety zones.
 - Initial and ongoing coordination with fire agencies and fire command.
 - Activate Project control center as necessary.
- Secondary:
- Assist suppression efforts with available resources.
 - Assist local and regional Emergency Response agencies.
 - Minimize health and environmental hazards.
 - Damage assessment both locally and Project wide.
- Intermediate to Long-Term:
- Recovery planning.
 - Impact analysis

5.3 TRAFFIC CORRIDOR DISRUPTION

Further guidance is provided in the Transportation Management Plan (Appendix B1).

Hazard:	<u>Traffic Corridor Disruption</u> The Project's transmission line route crosses numerous small road corridors, primarily National Forest System (NFS) roads and other rural roads such as Long Valley Road. Near its southern end, it crosses several community roads on the outskirts of Verdi. These traffic corridors will also be used for transportation of Project crews, equipment, and materials.
Severity:	The potential for disruption of the transportation corridor during line construction, or during normal travel is low to moderate.
Assumptions:	All road crossings are pre-planned to mitigate traffic disruptions. Permits are obtained from the appropriate highway and law enforcement authorities. They participate in the planning of traffic corridor crossings and are notified prior to starting construction activities with their areas of control. The transportation of equipment and materials will follow federal, state, county, and Project safety requirements.
Consequences:	<ul style="list-style-type: none">• Potential of injuries and fatalities.• Logistical response difficulties.• Corporate/public perception, confidence.
Key Response:	Immediate: <ul style="list-style-type: none">• Notify local law enforcement and Emergency Medical Services as required.• Engage authorities.• Activate Mutual Assistance Agreements Manual, if necessary (nearest utility to clear safety hazard).• Immediate area hazard identification, remove hazards, and establish safe zones.• Activate emergency response activities, i.e., control center.• Assist local and regional emergency response agencies. Secondary: <ul style="list-style-type: none">• Assess damage, local structural, equipment, and materials.• Coordinate with local and regional agencies.• Vital services and infrastructure recovery activities. Intermediate to Long-Term: <ul style="list-style-type: none">• Recovery planning.• Impact analysis.

6.0 EMERGENCY CONTACTS

Table 1 Emergency Contact List

(This list will be verified and updated by NV Energy and/or the construction contractor(s) as needed during construction, operation, and maintenance.)

IN CASE OF EMERGENCY	
Call 911	
FIRE	
Call 911 first	
Sierra Front Interagency Dispatch (775) 883-3535 for Emergencies (775) 883-5995 for Administration	
USFS Humboldt-Toiyabe National Forest Forest Supervisors Office 775-331-6444 Carson Ranger District: (775) 882-2766 (Business hours M-F, 8:00-4:30pm, except Federal Holidays).	BLM Eagle Lake Field Office: (530) 257-0456 (Business hours M-F, 8:00-4:30pm, except Federal Holidays).
COUNTY SHERIFFS	
Sierra County Sheriff: (530) 289-2850	Washoe County Sheriff: (775) 328-3001
POLICE	
City of Reno Police Department 911 for emergencies (775) 334-2175	
POISON CONTROL	
(800) 222-1222	
HOSPITALS AND CLINICS	
<p>In Washoe County, Nevada:</p> <ul style="list-style-type: none"> • Saint Mary's Regional Medical Center 235 W 6th St Reno, NV 89503 (775) 770-3000 • Renown Regional Medical Center 1155 Mill Street Reno, NV 89502 (775) 982-4100 <p>(See Appendix A for directions)</p>	

HAZARDOUS SPILL RESPONSE AND NOTIFICATION		
Directly after 911 notification, the following mandatory notifications will be made by the environmental field supervisor. Select and notify the appropriate government agency(ies) based on geographic location of the spill site. See Hazardous Materials Management and Spill Prevention, Control, and Countermeasure Plan in Appendix A2.		
Call 911 first.	If after hours and the spill is located in Nevada, call the Nevada Highway Patrol Dispatch at: (775) 687-5300.	If after hours and the spill is located in California, call the California Highway Patrol Dispatch at: 1-800-835-5247
National Response Center: (800) 424-8802	Nevada Office of Emergency Management: (775) 687-0400	Nevada Division of Environmental Protection: (775) 687-9485
California Governor's Office of Emergency Services State Warning Center: (800) 852-7550	Sierra County, California Office of Emergency Services: (530) 289-2850	Washoe County, Nevada Risk Management Division: (775) 328-2665
NV ENERGY		
Laura Clifford Project Manager Phone: (775) 834-3260 Fax: (775) 834-4659 LClifford@nvenergy.com	Lee Simpkins Environmental Supervisor Phone: (775) 834-3528 Fax: (775) 834-3158 lsimpkins@nvenergy.com	
U.S. FOREST SERVICE		
Marnie Bonesteel Special Use Administrator/ COM Plan Project Manager 1200 Franklin Way Sparks, NV 89431 Phone: 775-331-6444 Desk: (775) 352-1240 Cell: 775-221-9225 marnie.bonesteel@usda.gov	TBD Field Monitor	
BUREAU OF LAND MANAGEMENT		
TBD Compliance Manager	TBD Field Monitor	
CONSTRUCTION CONTRACTOR		
To be determined	To be determined	



NV ENERGY – SINGLE INSPECTION PROGRAM (SIP) TEAM		
TBD Environmental Field Supervisor	TBD Environmental Field Coordinator	TBD Environmental Field Inspector
		TBD Environmental Field Inspector
		TBD Environmental Field Inspector
		TBD Environmental Field Inspector
	TBD Flagging and Fencing Crew	TBD Environmental Field Inspector

APPENDIX A

Hospitals Directions

Directions to Hospitals

Saint Mary's Regional Medical Center

235 W 6th St
Reno, NV 89503
775-770-3000

Directions from Verdi (Bridge Street area):

- Head southeast on Bridge Street towards Front Street;
- Turn right onto S. Verdi Road;
- Turn left onto the Route 80 East ramp;
- Merge onto Interstate 80 East
- Take Exit 13 toward Downton Reno/Virginia Street;
- Turn Right onto North Sierra Street;
- Turn Right onto West 6th Street.

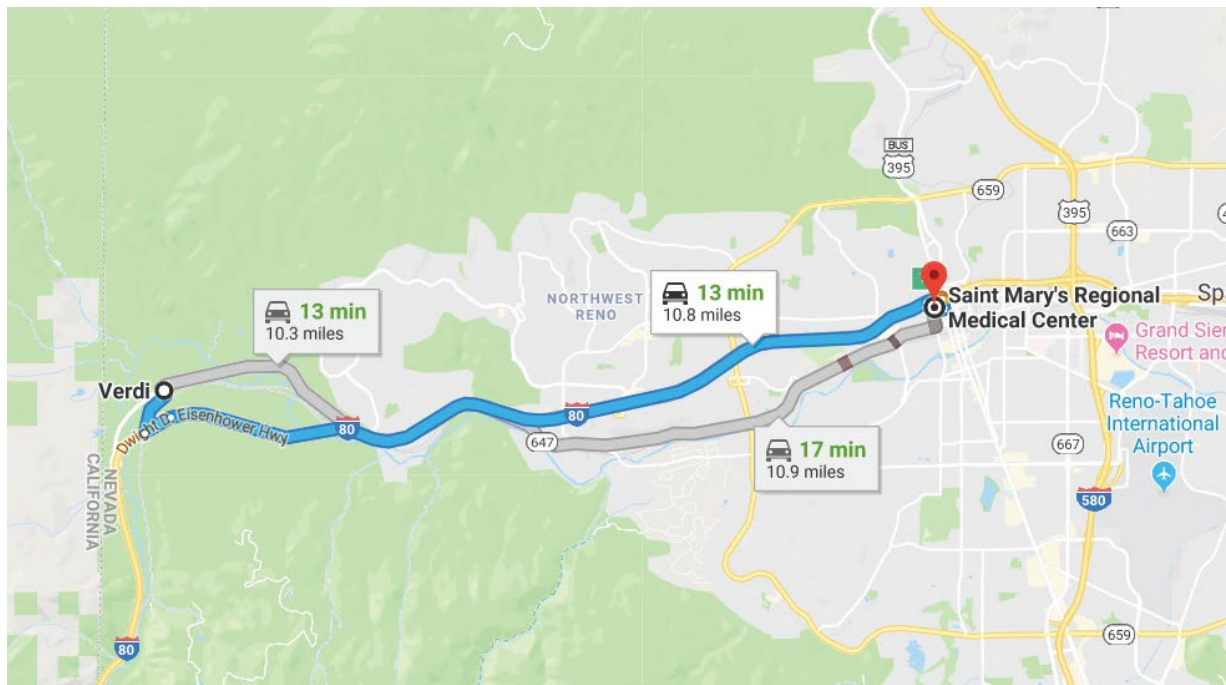

Directions from Bordertown (Casino and RV Resort area):

- Get on US-395 South;
- Take Exit 68 towards I-80 West;
- Take Exit 13 and continue straight to North Sierra Street;
- Turn left on North Sierra Street.

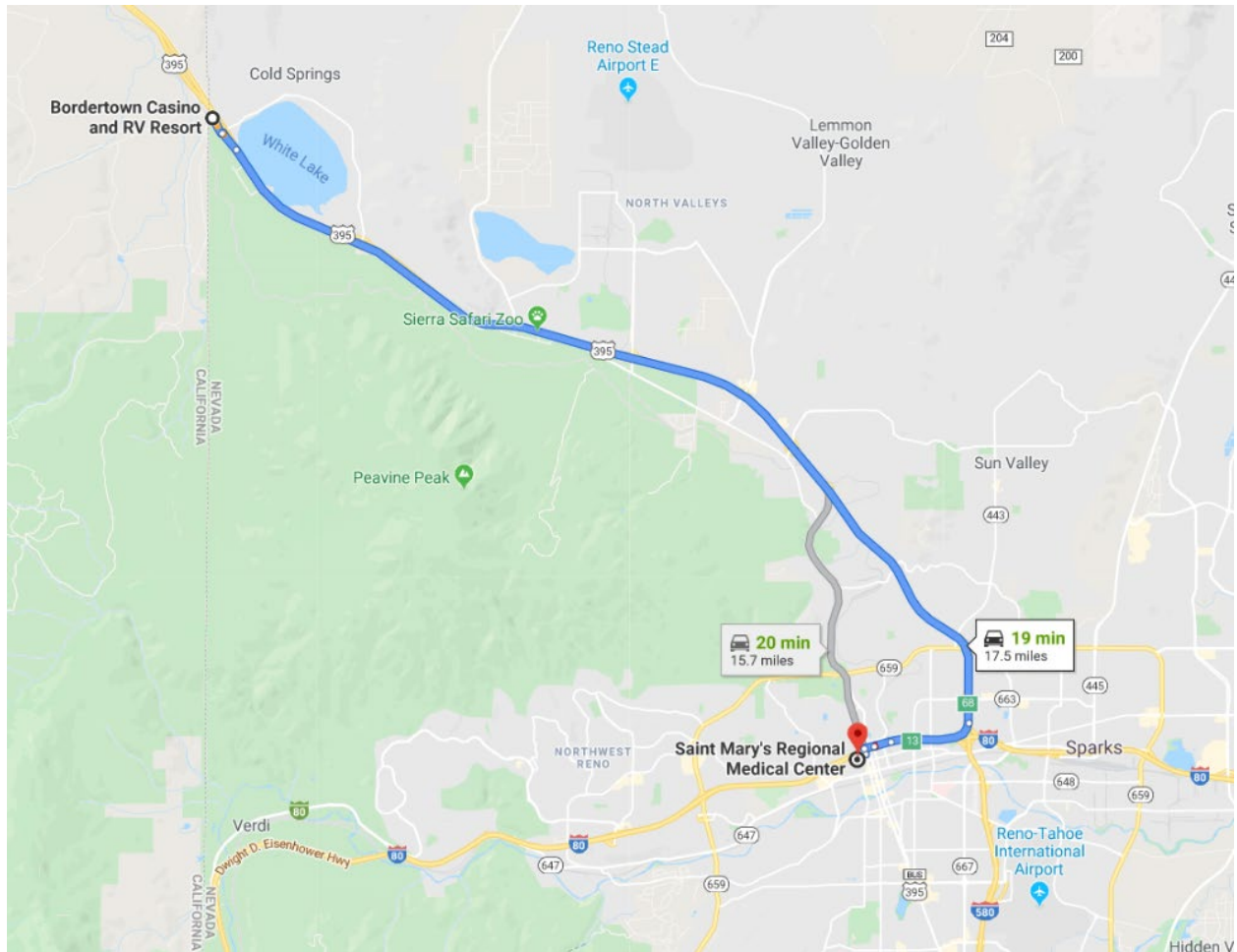

Renown Regional Medical Center

1155 Mill Street
Reno, NV 89502
775-982-4144

Directions from Verdi (Bridge Street area): Head southeast on Bridge Street toward Front Street.
Turn right onto South Verdi Blvd.
Turn left onto the Route 80 East ramp.
Follow I-80 East to North Wells Ave.
Take Exit 14 from I-80 East.
Turn right onto North Wells Ave.
Turn left onto Mill Street.

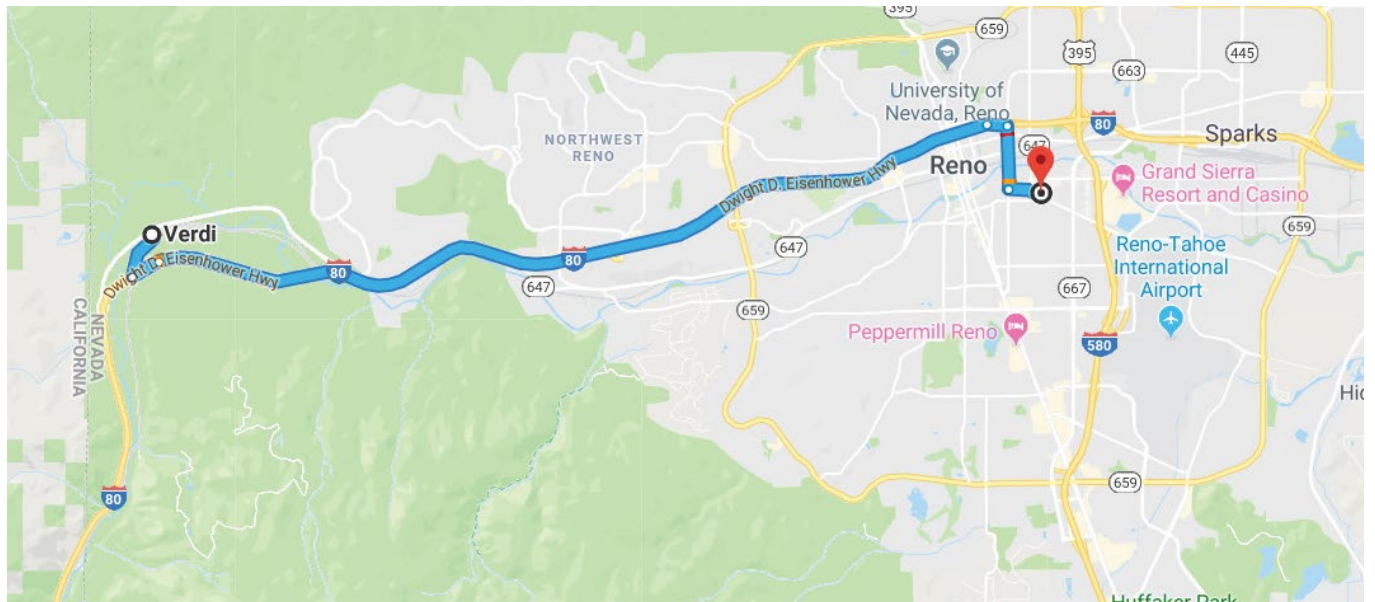

Directions from Bordertown (Casino and RV Resort area):

- Get on US-395 South;
- Continue onto I-580 South/US-395 South;
- Merge onto US-395 South;
- Take Exit 66 for Mill Street;
- Turn right onto Mill Street.

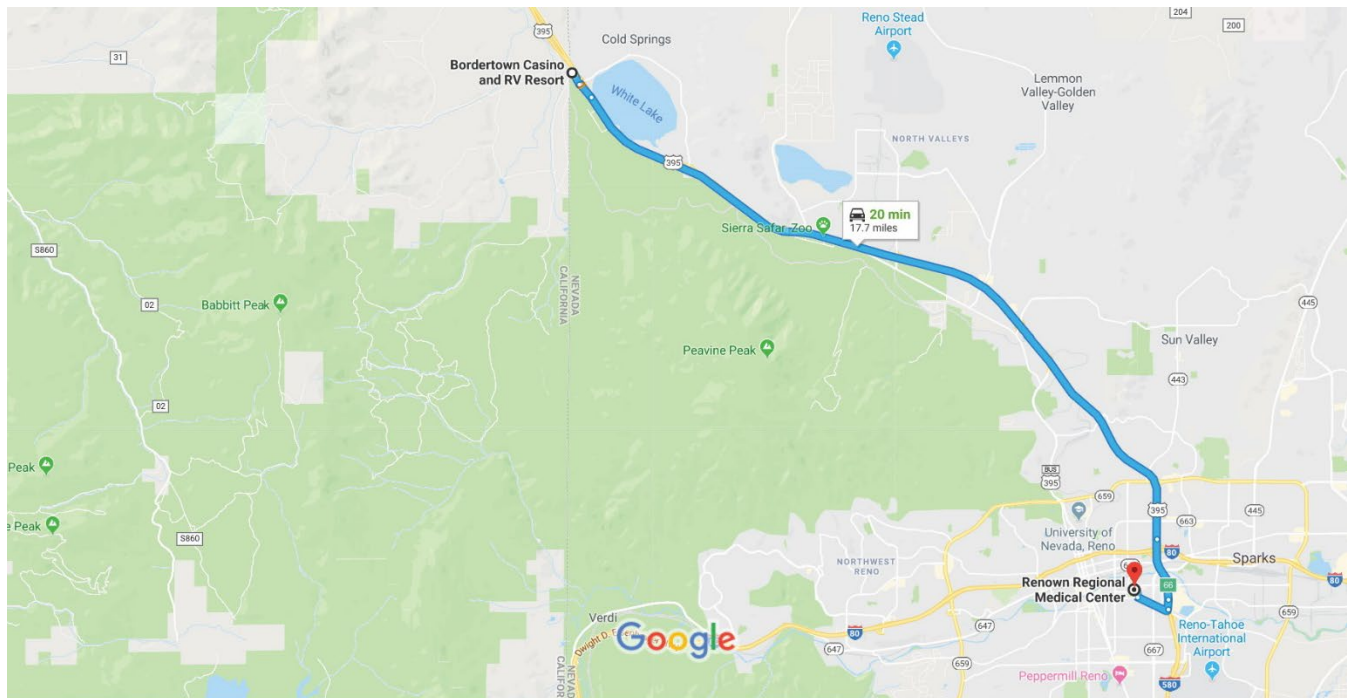

APPENDIX B

NV Energy's COVID-19 Response Plan

Purpose:	To set expectations of contractors in support of NV Energy's COVID-19 response plan and outline contractor expectations in a consolidated document.
Scope:	Applies to all planned or emergency work contractors perform for NV Energy during the COVID-19 emergency plan.
Roles:	This policy is for NV Energy contractors and their personnel while working at NV Energy facilities and/or physically interfacing with NV Energy employees.

1.0 Purpose

NV Energy (NVE) provides essential services to its customers and reasonable efforts must be made to avoid the interruption of those services. Under occupational safety and health regulations, NVE has a duty to maintain a safe workplace. That duty includes taking reasonable measures to prevent the spread of disease. COVID-19 virus (Novel Coronavirus) is spreading globally. NVE is closely monitoring the U.S. Centers for Disease Control and Prevention (CDC) and the World Health Organization for the latest developments on the virus. The Nevada Occupational and Safety Health Administration (NV OSHA) requires everyone wash their hands, maintain six foot separation from others, and not come to work if showing symptoms. These are some of the simplest and most effective measures to fight communicable diseases. In addition to these safety precautions, NVE is issuing the following updated policy for its contractors.

2.0 Background

March 13, 2020: NVE directed contractors to monitor and manage their employees' travel according to the high-risk jurisdictions designated by the CDC; as well as ongoing developments as they pertain to COVID-19. This included notifying NVE if employees had travelled to, or had family travel to one of the CDC-targeted COVID-19 countries.

March 15, 2020: CDC issued Level Three or Level Two Travel Health Notices for the following areas: China, Iran, South Korea, Japan, the U.K., Ireland, Venezuela and most countries in Europe. For purposes of this policy, these countries are considered high-risk jurisdictions. All business travel to high-risk jurisdictions is prohibited. In addition, some locations in the United States have been designated as high-risk locations.

March 18, 2020: NV OSHA issued a COVID-19 letter providing social distancing protocols and measures for the management of staff and labor in the mining, construction, and manufacturing industry sectors. See Appendix A. These protocols include:

- Meetings, tailboards, and other gatherings
- Social distancing
- Sanitation and cleaning supplies
- Labor transportation
- Daily surveys
- First responders
- Potable and sanitary water

March 26, 2020: NV OSHA issued a second COVID-19 letter re-emphasizing social distancing safeguards and notified contractors of random site audits to ensure these safeguards are in place. See Appendix B.

March 31, 2020: The Nevada Governor issued a Travel Advisory for Nevada, recommending no non-essential travel and urging anyone returning to/arriving in Nevada to self-quarantine and monitor their health for 14 days. See Appendix C.

April 1, 2020: NVE issued an email notification to its contractors relaying the NV OSHA requirements and our commitment to uphold and implement these requirements. The March 26, 2020 NV OSHA letter was attached.

3.0 Current Notification and Self-quarantine Requirements

Generally, contract employees are considered essential to NVE business and will not be required to quarantine if they meet the requirements outlined below.

The Centers for Disease Control and Prevention have issued Level Three or Level Two Travel Health Notices for the following countries: China, Iran, South Korea, Japan, the U.K., Ireland, Venezuela and most countries in Europe. In addition, some locations in the United States have been designated as high-risk or hot spot locations. See <https://www.cdc.gov/coronavirus/2019-ncov/travelers/map-and-travel-notices.html> and click on each country for the latest list high risk locations and travel advisories. For purposes of this policy, these areas are considered high-risk jurisdictions.

Contractors with employees that work at an NVE facility or job site must review their employee's business and personal travel to high-risk international and domestic locations, and review it with NVE on a case-by-case basis. The contractor's employees may be required to self-isolate, self-monitor and refrain from entry to an NVE facility or job site for 14 days upon return from travel.

For domestic travel to areas that are not considered high risk or hot spot locations, contractors with employees that work at an NVE facility or job site must review their employee's business and personal travel to international and domestic locations, and disclose it to NVE. NVE will review out-of-state domestic travel disclosures on a case-by-case basis to determine whether self-isolation for 14 days is required. This does not apply to contract employees who travel to home residences in neighboring states (Utah, Arizona, or California) unless traveling to a high risk location.

Contractor employees who are assigned to work remotely do not need to disclose out-of-state domestic travel to NVE but are expected to self-isolate, self-monitor and refrain from entry to a NVE facility for 14 days upon return from travel. Contractors should be following any state and federal guidelines regarding personal protective equipment (PPE). NVE may require additional PPE for contractors and would be determined on a case by case basis. PPE would be supplied by the Contractor.

Contractors must immediately notify NVE if any employee:

- 1) Has tested positive or is presumptive positive for COVID-19,
- 2) Has been in close contact or had prolonged exposure with someone who has tested positive or is presumptive positive for COVID-19,
- 3) Lives in a household with someone who has travelled to a high-risk jurisdiction,
- 4) Has recently traveled or plans to travel domestically outside of Nevada (other than to/from their home residence unless traveling to a high risk location),
- 5) Has recently traveled or plans to travel internationally for business or personal purposes,
or
- 6) Lives in a household with someone who plans to travel internationally.

Your NVE Representative will work with NVE Human Resources will evaluate any risk and may require the employee to take additional precautions based on the risk assessment.

Note there may be local or NVE site-specific policies in addition to this policy, for example, if a medical clearance is required to return to work. A screening may be required if the employee's medical condition poses a significant risk of substantial harm to the health or safety of the employee, or others. The contractor should work closely with their NVE representative to understand any additional expectations or restrictions.

4.0 Temperature Check

To further enhance safety and individual health awareness during the current COVID-19 conditions, NV Energy is providing guidance, based on CDC guidance, related to temperature checks. This guidance is for contractors, including subcontractors and any other personnel to take their temperature prior to entering NVE facilities or jobsites. This guidance asks each individual to take their temperature and ensure that they are healthy before reporting to NVE facilities or jobsites. This guidance further requires individuals working within any of the Company's Halo Zones (control centers, control rooms, trading floor, gas dispatch) to take their temperature and ensure that they are healthy before reporting for duty to a Halo Zone area.

- 1) For any contractors who continue to come into Company facilities or work in the field, the Company asks each individuals to check their temperature prior to reporting to work.
- 2) For contractors working in a Company-identified Halo Zone (control centers, control rooms, trading floor, gas dispatch), the Company is requiring individuals to check their temperature prior to reporting to work.
- 3) To report to work or continue to work at Company facilities or in the field, their temperature must be below 100.4 degrees (F) without the use of Aspirin, Ibuprofen or other fever-reducing medicines.
- 4) Contractors having a temperature of 100.4 degrees (F) must notify their NVE representative. If a temperature check, exceeding this threshold, is taken at a Company facility or in the field, contractors are instructed to immediately isolate themselves and leave the facility or field and contact their NVE representative after leaving.
- 5) Contractors having a temperature of 100.4 degrees (F) will not be permitted to enter Company facilities or the field until the contractor is symptom free (without the use of Aspirin, Ibuprofen or other fever-reducing medicines) for a minimum of 3 days.
- 6) Any contractors who have actual exposure to others with confirmed cases of the COVID-19 virus are required to notify their NVE Representative and may be required to self-quarantine for 14 days.
- 7) The NVE Representative will work with NVE Human Resources to evaluate any risk and may require the contract employee to take additional precautions based on the risk assessment.

5.0 Evidence of Business Relationship

NVE leadership has been in contact with the Governor's office, and it is recognized that reliable gas and electric service is essential to the safety and well-being of the community, especially during this

very difficult time for our customers. As a result, our contractors play a vital role in maintaining the effective delivery of these essential services. NVE has no objection to the contractor's use of its NVE purchase orders as evidence of the relationship between our companies. If the contractor chooses to carry a purchase order as evidence, they are encouraged to redact any pricing on hardcopies. Should you need a copy of a particular purchase order or a special circumstance requires a unique authorization letter, please contact your contract administrator with sufficient detail to provide the necessary documents.

Contractors may have employee with specific work assignments that require a more detailed letter outlining the job function and the business need. Contact you NVE representative who will work with internal departments to provide the necessary documents.

The policy may be modified as the situation changes. Please contact your NVE contract administrator with any questions. For Energy Supply contracts, please contact Cynthia Alejandre at CAlejandre@nvenergy.com. For Electric Delivery contracts, please contact Christer Hargrove at CHargrove@nvenergy.com.

6.0 Appendix

- A. NV OSHA Memorandum dated March 18, 2020 (3 pages)
- B. NV OSHA Memorandum dated March 26, 2020 (2 pages)
- C. NV Governor's Travel Advisory dated March 31, 2020 (2 pages)

7.0 Revisions

- 0.0 Original document, dated April 7, 2020.
- 1.0 Added Section 4.0 Temperature Check, dated April 16, 2020

STATE OF NEVADA

Steve Sisolak
Governor

Terry Reynolds
Director



Ray Fierro
Administrator

Victoria Carreón
Deputy Administrator

Jess Lankford
Chief Administrative Officer

DEPARTMENT OF BUSINESS AND INDUSTRY
DIVISION OF INDUSTRIAL RELATIONS
OCCUPATIONAL SAFETY AND HEALTH ADMINISTRATION

March 18, 2020

To Whom It May Concern,

This memorandum provides guidelines for the management of staff and labor in the mining, construction, and manufacturing industry sectors. This memorandum supports and enhances Governor Steve Sisolak's March 18, 2020 document titled, "Nevada Health Response COVID-19 Risk Mitigation Initiative."

As identified by the Governor of Nevada, the implementation of the following protocols is extremely important to reduce and slow the spread of COVID-19. The Governor has tasked every business and business sector with the responsibility to do whatever it can to address the historic public health issue.

The following are social distancing protocols and measures that are to be initiated immediately:

Mining:

- ▶ Restrict meetings, safety meetings/tailgate talks, and gatherings to no more than 10 people. (Ref. - Guidance on Preparing Workplaces for COVID-19, OSHA 3990-03 2020)
- ▶ Establish effective social distancing protocols, which ensure that staff maintain a 6 foot personal separation from other staff during meetings, discussions, etc. where 10 people or less are present. Ensure that social distancing protocols are maintained during operation of mobile service equipment designed for 2 or more passengers including, but not limited to, man lifts, scissors lifts, etc. (Ref. - Guidance on Preparing Workplaces for COVID-19, OSHA 3990-03 2020)
- ▶ Provide sanitation and cleaning supplies for addressing common surfaces in multiple user mobile equipment and multiple user tooling. (Ref. - Guidance on Preparing Workplaces for COVID-19, OSHA 3990-03 2020)
- ▶ Maintain 6 foot separation protocols for labor transportation services, such as buses, vans, etc.
- ▶ Conduct daily surveys of changes to staff/labor health conditions. (Ref. - Guidance on Preparing Workplaces for COVID-19, OSHA 3990-03 2020)
- ▶ Ensure that any identified first responders in the labor force are provided and use the needed Personal Protective Equipment (PPE) and equipment for protection from communicable or infectious disease. (29 CFR 1910.1030)
- ▶ Provide access to potable and sanitary water (30 CFR 56, and 57)

LAS VEGAS
3360 West Sahara Avenue
Suite 200
Las Vegas, NV 89102
(702) 486-9020

RENO
4600 Kietzke Lane,
Building F-153
Reno, NV 89502
(775) 688-3700

Construction:

- ▶ Restrict meetings, safety meetings/tailgate talks, and gatherings to no more than 10 people. (Ref. - Guidance on Preparing Workplaces for COVID-19, OSHA 3990-03 2020)
- ▶ Establish effective social distancing protocols, which ensure that staff maintain a 6 foot personal separation from other staff during meetings, discussions, etc. where 10 people or less are present. Ensure that social distancing protocols are maintained during operation of mobile service equipment designed for 2 or more passengers including, but not limited to, man lifts, scissors lifts, etc. (Ref. - Guidance on Preparing Workplaces for COVID-19, OSHA 3990-03 2020)
- ▶ Provide sanitation and cleaning supplies for addressing common surfaces in multiple user mobile equipment and multiple user tooling. (Ref. - Guidance on Preparing Workplaces for COVID-19, OSHA 3990-03 2020)
- ▶ Maintain 6 foot separation protocols for labor transportation services, such as buses, vans, etc.
- ▶ Conduct daily surveys of changes to staff/labor health conditions. (Ref. - Guidance on Preparing Workplaces for COVID-19, OSHA 3990-03 2020)
- ▶ Ensure that any identified first responders in the labor force are provided and use the needed Personal Protective Equipment (PPE) and equipment for protection from communicable or infectious disease. (29 CFR 1910.1030)
- ▶ Provide access to potable and sanitary water (29 CFR 1926.15)

Manufacturing:

- ▶ Restrict meetings, safety meetings/tailgate talks, and gatherings to no more than 10 people. (Ref. - Guidance on Preparing Workplaces for COVID-19, OSHA 3990-03 2020)
- ▶ Establish effective social distancing protocols, which ensure that staff maintain a 6 foot personal separation from other staff during meetings, discussions, etc. where 10 people or less are present. Ensure that social distancing protocols are maintained during operation of mobile service equipment designed for 2 or more passengers including, but not limited to, man lifts, scissors lifts, etc. (Ref. - Guidance on Preparing Workplaces for COVID-19, OSHA 3990-03 2020)
- ▶ Provide sanitation and cleaning supplies for addressing common surfaces in multiple user mobile equipment and multiple user tooling. (Ref. - Guidance on Preparing Workplaces for COVID-19, OSHA 3990-03 2020)
- ▶ Maintain 6 foot separation protocols for labor transportation services, such as buses, vans, etc.
- ▶ Conduct daily surveys of changes to staff/labor health conditions. (Ref. - Guidance on Preparing Workplaces for COVID-19, OSHA 3990-03 2020)
- ▶ Ensure that any identified first responders in the labor force are provided and use the needed Personal Protective Equipment (PPE) and equipment for protection from communicable or infectious disease. (29 CFR 1910.1030)
- ▶ Provide access to potable and sanitary water (29 CFR 1910.141)

For any further guidance use the following links

Federal OSHA - <https://www.osha.gov/SLTC/covid-19/>

Center for Disease Control and Prevention - <https://www.cdc.gov/coronavirus/2019-nCoV/index.html>

State of Nevada - <https://nvhealthresponse.nv.gov/>

Mine Safety and Health Administration: <https://www.msha.gov/>

Nevada OSHA Information: <http://dir.nv.gov/OSHA/Home/>

**THIS GUIDANCE IS SUBJECT TO REVISION AS ADDITIONAL
INFORMATION IS GATHERED. PLEASE CHECK HERE FREQUENTLY FOR
UPDATES.**

Sincerely,

Jess Lankford

Chief Administrative Officer

Phone # 702.486.9020

LAS VEGAS
3360 West Sahara Avenue
Suite 200
Las Vegas, NV 89102
(702) 486-9020

RENO
4600 Kietzke Lane,
Building F-153
Reno, NV 89502
(775) 688-3700

STATE OF NEVADA

Steve Sisolak
Governor

Terry Reynolds
Director



Ray Fierro
Administrator

Victoria Carreón
Deputy Administrator

Jess Lankford
Chief Administrative Officer

DEPARTMENT OF BUSINESS AND INDUSTRY
DIVISION OF INDUSTRIAL RELATIONS
OCCUPATIONAL SAFETY AND HEALTH ADMINISTRATION

March 26, 2020

Ref: March 18th, 2020 Nevada Governor's "Nevada Health Response COVID-19 Risk Mitigation Initiative."

To Whom It May Concern,

In recent days the administration of the Nevada Occupational Safety and Health Administration (NVOSHA) has conducted intermittent surveys of active construction sites in Nevada. At many of these work sites it is visibly obvious that employees are still being directed/allowed to work in close proximity (less than 6 feet of separation) to other staff.

On March 18th, 2020 NVOSHA published a set of guidelines in support of the March 18th Governors mitigation initiative, which are available at:

[http://dir.nv.gov/uploadedFiles/dirnv.gov/content/home/features/OSHA%20COVID%2019%20Guidance%20\(004\)\(1\).pdf](http://dir.nv.gov/uploadedFiles/dirnv.gov/content/home/features/OSHA%20COVID%2019%20Guidance%20(004)(1).pdf)

The NVOSHA guidelines referenced construction operations and provided the following:

Construction:

- ▶ Restrict meetings, safety meetings/tailgate talks, and gatherings to no more than 10 people. (Ref. - Guidance on Preparing Workplaces for COVID-19, OSHA 3990-03 2020)
- ▶ Establish effective social distancing protocols, which ensure that staff maintain a 6 foot personal separation from other staff during meetings, discussions, etc. where 10 people or less are present. Ensure that social distancing protocols are maintained during operation of mobile service equipment designed for 2 or more passengers including, but not limited to, man lifts, scissors lifts, etc. (Ref. - Guidance on Preparing Workplaces for COVID-19, OSHA 3990-03 2020)
- ▶ Provide sanitation and cleaning supplies for addressing common surfaces in multiple user mobile equipment and multiple user tooling. (Ref. - Guidance on Preparing Workplaces for COVID-19, OSHA 3990-03 2020)
- ▶ Maintain 6 foot separation protocols for labor transportation services, such as buses, vans, etc.
- ▶ Conduct daily surveys of changes to staff/labor health conditions. **NV OSHA is emphasizing the need for construction leadership to be working with and aware of the health and well-being of its labor force.** Many leaders in the construction industry have implemented entry surveys of labor health conditions that have, and may, include temperature scans and in person Q&A. (Ref. - Guidance on Preparing Workplaces for COVID-19, OSHA 3990-03 2020)
- ▶ Ensure that any identified first responders in the labor force are provided and use the needed Personal Protective Equipment (PPE) and equipment for protection from communicable or infectious disease. (29 CFR 1910.1030)

LAS VEGAS
3360 West Sahara Avenue
Suite 200
Las Vegas, NV 89102
(702) 486-9020

RENO
4600 Kietzke Lane,
Building F-153
Reno, NV 89502
(775) 688-3700

- ▶ Provide access to potable and sanitary water (29 CFR 1926.15)

On March 20th, 2020 the Governor of Nevada set forth a Declaration of Emergency Directive 003, which is available at: <https://nvhealthresponse.nv.gov/wp-content/uploads/2020/03/2020-03-20.Declaration-of-Emergency-Directive-003.pdf>

In this declaration, within Section 6, the Governor states specifically “Business sectors operating under this authority must comply with any applicable COVID-19 risk mitigation policies, as further defined in regulations promulgated under this Directive, and any precautionary measures and guidance that shall be promulgated by Nevada Department of Business and Industry.” Section 8 states, in part, “Businesses ... may continue operations, ..., if they are able to implement social distancing safeguards for the protection of their employees...”. (Emphasis added).

As a result of the “Emergency Directive 003” the NVOSHA COVID-19 response guidelines for construction are required.

NVOSHA seeks to ensure that all construction companies comply with the aforementioned mandates and also seeks to distribute this information so that construction businesses are fully aware of these requirements. If your business, group, or association is receiving this memo then please recognize this memo as notice to your business, group, or association that the previously mentioned mandates and guidance must be adopted and put into effect.

If you are receiving this memo and are associated with a building group or association we request that you immediately distribute this memo to all General Contractors, Subcontractors, or any other representatives of construction sector businesses that this information may apply to, including but not limited to, inspectors, utilities, vendors, material suppliers, independent contractors, or any other companies having employees present at a Nevada construction site.

NV OSHA will be conducting random onsite inspections to ensure that the Governor’s mandates are followed and implemented accordingly.

Failing to comply with the Governor’s Emergency Declaration 003 and associated, promulgated regulations, or guidance will be considered non-compliance with these mandates and may result in the penalizing or closure of any construction site or project that falls under the scope of the Governor’s Emergency Declaration. (Ref. Sections 9 & 10 of the Nevada Emergency Declaration 003)

Thank you in advance for addressing the concerns of the State of Nevada in a timely fashion.

Sincerely,

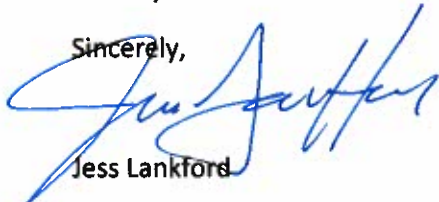

Jess Lankford

Chief Administrative Officer NVOSHA

CC:

Terry Reynolds

LAS VEGAS
3360 West Sahara Avenue
Suite 200
Las Vegas, NV 89102
(702) 486-9020

RENO
4600 Kietzke Lane,
Building F-153
Reno, NV 89502
(775) 688-3700



**NEVADA
HEALTH
RESPONSE**

FOR IMMEDIATE RELEASE
March 31, 2020

CONTACT: Meghin Delaney
Public Information Officer
mdelaney@nvhealthresponse.nv.gov

Governor Sisolak issues travel advisory for State of Nevada

Carson City, NV — Today, Nevada Governor Steve Sisolak issued a travel advisory for the State of Nevada, urging visitors or returning Nevadans to self-quarantine and monitor their health for 14 days after arriving or returning to Nevada to help contain the spread of COVID-19 in Nevada.

“We know this virus does not spread on its own so we need everyone, Nevadans and travelers, to take preventive measures to help flatten the curve and protect the most vulnerable among us,” said Gov. Sisolak. “Nevada will always be a welcoming spot for travelers, but out of an abundance of caution, we are asking everyone to Stay Home for Nevada, especially if you have symptoms.”

Travelers are urged to self-quarantine and monitor their health for 14 days or the duration of their stay in Nevada, whichever is shorter. Travelers and returning Nevadans should not visit any public place or come into contact with those who are not members of their household unit.

The Governor is also strongly urging Nevadans to avoid non-essential travel during this time period as well, especially to places [where the CDC has issued travel advisories](#). For Nevada residents who live in communities that border other states, please practice aggressive social distancing if you must cross state lines for essential daily matters.

This advisory does not apply to healthcare, public health, public safety, transportation, and food supply essential employees.

If you are traveling in Nevada and are experiencing symptoms (fever, cough, shortness of breath):

1. Continue to stay in your designated quarantine location, avoid contact with others, and contact a healthcare provider for further instructions on treatment or testing.
2. If you are older or have any medical conditions (e.g., immune compromise, diabetes, asthma), consult your regular healthcare provider.
3. If you feel you need medical care, call ahead before you go in and inform them of your travel history.
4. If you need urgent medical care (e.g., have difficulty breathing), call 9-1-1 and let the dispatcher know your travel history).

For more information, visit [nvhealthresponse.nv.gov](https://www.nvhealthresponse.nv.gov).

###

APPENDIX C

NV Energy's Wildland Fire Plan

NV Energy Wildland Fire Plan

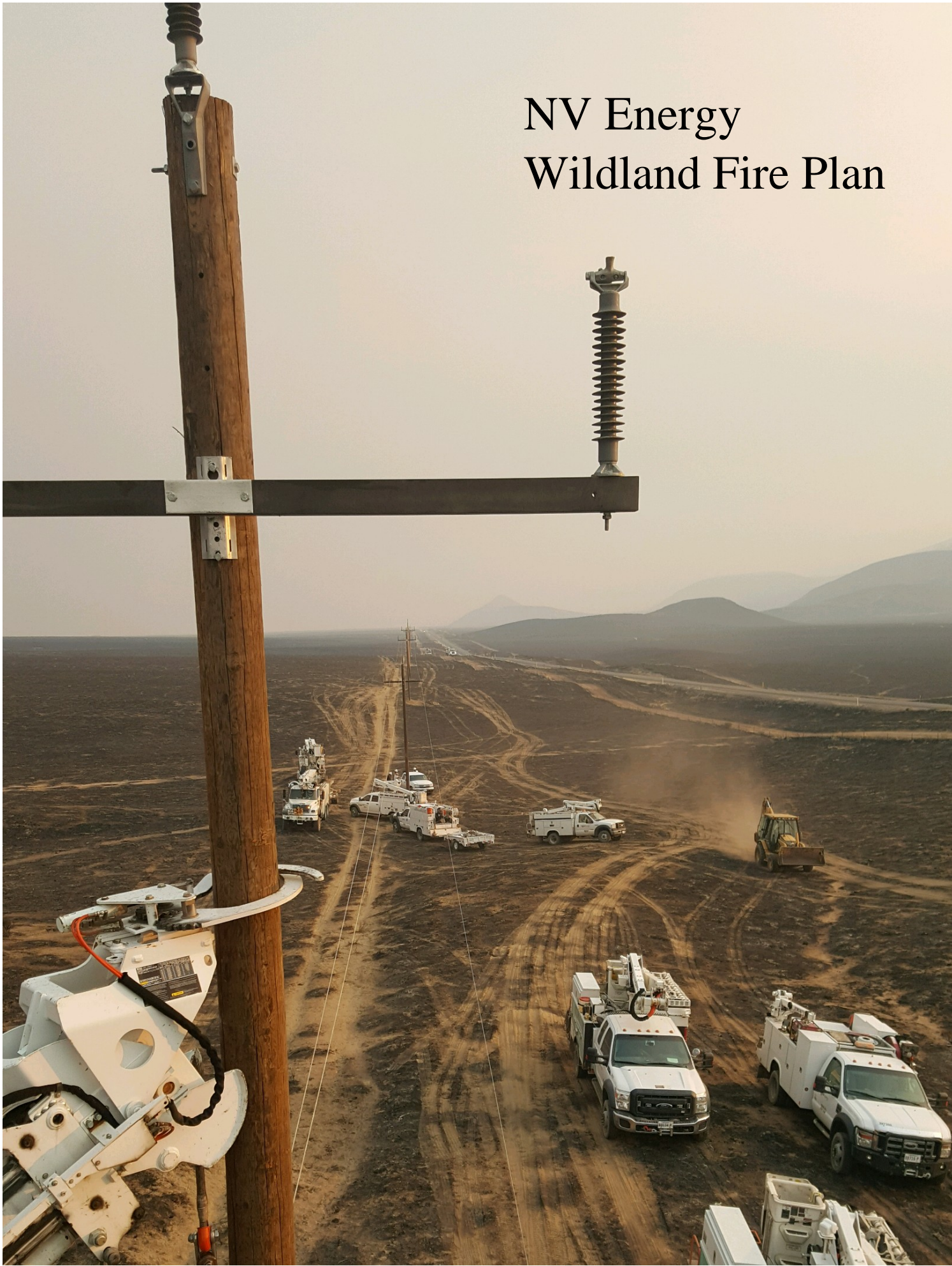



Table of Contents

Overview 2

1.0 Roles and Responsibilities 2

 1.1 Electric System Control Center (ESCC)..... 2

 1.2 Electric Fire Liaison..... 3

 1.3 NVE Electric Delivery Field Personnel (Lines and Substations) 3

 1.4 Emergency Management..... 4

 1.5 NVE Gas Operations..... 4

2.0 Wildland Fire Agency Contact Numbers..... 5

3.0 Wildland Fire Notification Route 6

4.0 Personal Protective Equipment 8

 4.1 Inventory List for Wildland Fire Bags..... 8

 4.2 Additional Equipment for Wildland Fire Bag..... 8

 4.3 Fire Locker Supplies at 1 Ohm 8

5.0 Pre-Trip Fire Pumper Inspection Form 9

6.0 Fire Pumper Pre-Trip Checklist 11

7.0 PRE-SEASON ACTIVITIES 11

 7.1 Emergency Management..... 11

 7.2 Field Operations..... 11

 7.3 GIS Support 12

 7.4 ESCC – Electric Dispatch..... 12

 7.5 Safety 12

 7.6 Substation Operations 13

 7.7 Substation/Transmission Civil Construction 13

 7.8 Fleet Operations 13

 7.9 Materials Operations..... 13

8.0 Record of Change 14

Overview

Purpose

To outline procedures and responsibilities required by staff in response to a wildland fire and how to work with external agencies during the emergency.

Scope

Applies to all employees involved in the wildland fire response – including office staff and field personnel.

1.0 Roles and Responsibilities

1.1 Electric System Control Center (ESCC)

Role: Provide current information to NV Energy (NVE) personnel to maintain optimal employee, equipment and public safety. Assure the electric system is operating in compliance with National and Federal guidelines.

Responsibilities

- If field personnel, a customer, or an outside agency calls to report a wildland fire that impacts NVE infrastructure; the electric dispatcher will request a troubleshooter respond to the scene to assess the potential impact.
- When a fire/dispatch agency or response agency calls NVE electric dispatch, the electric dispatcher will gather the following information to share with the Fire Liaison:
 - Where is the fire?
 - Who is the incident commander?
 - What is the incident commander's contact number?
 - Where is the Incident Command Post (cross streets or address is preferred)?
- Electric dispatch will notify Lines Duty Supervisor and/or Substation Duty Supervisor that there is a fire in the area and a Fire Liaison is needed.
- Electric dispatch should inform the Fire Liaison of any requests from outside agencies that come directly to them regarding de-energizing lines. This will ensure constant and accurate communication between all departments involved.
- Assist with requests from the field to de-energize and/or re-energize lines affected by the fire or for safety concerns.

1.2 Electric Fire Liaison

Role: Act as the NV Energy representative to the Incident Commander (IC) at the Incident Command Post (ICP).

Responsibilities

- Provide coordination between responding fire agencies, NVE field personnel, and system control.
- Contact fire dispatching agency (see contact list at the end of this procedure) to acquire additional information including Point of Contact, POC phone number, Incident Command location, and any other pertinent information that is available, such as extent of fire.
- Contact Incident Commander by phone, exchange contact information, and get more details about the fire including: extent, location, and proximity to our facilities and need for response by NVE field personnel including de-energizing line or accessing damaged area to repair facilities.
- Attend operational briefings at the Incident Command Post (ICP), if appropriate, to exchange information.
- Provide fire information to NVE GIS to prepare map overlaying NVE facilities in fire map.
- Obtain status of NVE electric system and requirements from the field personnel of affected departments to relay to fire Incident Command.
- Communicate with appropriate stakeholders in Electric Delivery to provide requirements for the NVE responding crews including what PPE is required, if any, potential hazards to be aware of, and Incident Command contact information.
- Maintain communication and provide updates to impacted stakeholders.
- Relay next operational period NVE objectives/tasks to Incident Commander.

1.3 NVE Electric Delivery Field Personnel (Lines and Substations)

Role: Serve as the on-scene subject matter experts for NVE infrastructure. Coordinate efforts to mitigate effects of the fire to assets, as well as, repair or replace damaged facilities. Provide current information to NVE personnel to maintain optimal employee, equipment, and public safety.

Responsibilities

- Upon notification of a wildland fire incident, the Lines Duty Supervisor and/or Substation Duty Supervisor will designate an NVE employee with operational knowledge to become the Fire Liaison for that event.
- Prior to assessing damage, or making repairs, report to the ICP or established staging area.
- Conduct check-in activities with the Incident Command Operations Section Chief upon arrival and departure.
- Ensure timely and accurate communication between field personnel, the duty supervisor and the fire liaison, as needed.

- Field personnel working in the area of a wildland fire will wear their yellow fire gear and any other personal protective equipment necessary, or instructed to by fire agencies.
- Conduct standard crew operations.
- Crews will provide a report to the Duty Supervisor when they leave the incident, including the status of completed repairs and if additional repairs are required.

1.4 Emergency Management

Role: Provide essential coordination between agencies, jurisdictions, and NVE during wildland fires.

Responsibilities

- Assist Executive in Charge (EIC) with notifying Emergency Response Organization (ERO) of activation.
- Send alert notification to ERO regarding upcoming emergency calls.
- Gather relative information about the event to be shared with NVE stakeholders during the ERO activation call.
- Respond to ICP, if EM personnel is available and NVE ERO or local EOCs are not activated. EM ICP response availability will depend on number of ICPs activated in the area and location of ICP.
- Respond and represent NVE at County and local Emergency Operation Center when activated.
- Compile NVE situation report to be sent out to NVE ERO by the EIC.

1.5 NVE Gas Operations

Role: Serve as the on-scene subject matter experts for NVE infrastructure. Coordinate efforts to mitigate effects of the fire to assets, as well as, repair, isolate, or replace damaged facilities. Assist fire personnel with shut off of gas supply to affected structures (commercial or residential). Provide current information to NVE Dispatch and personnel to maintain optimal employee, equipment, and public safety.

Responsibilities

- Upon notification of a wildland fire incident from fire dispatch, electric dispatch, or emergency management, the Gas Duty Supervisor will respond to ICP and work with the incident commander.
- Based on the needs of the incident, the Gas Duty Supervisor will coordinate the response of the NVE gas crews.
- Additional personnel/crews will conduct check-in activities with the Gas Duty Supervisor (located at the ICP) upon arrival and departure.



- Field personnel working in the area of a wildland fire will wear their Personal Protective Equipment (PPE).
- Ensure timely and accurate communication between field personnel and Gas Duty Supervisor to include a report when they leave the incident, including the status of completed repairs/shut-offs and if additional repairs or shut offs are required.
- If the event rises to the need for an Emergency Response Organization (ERO) response, Gas Duty Supervisor or leadership will notify emergency management.

2.0 Wildland Fire Agency Contact Numbers

- Minden Dispatch – Regional Resources Dispatched – (775) 883-5995
- Truckee Meadow Fire Protection District Fire Admin Line – (775) 785-4253
- Elko Dispatch Center – (775) 748-4030 or (775) 748-4000

Wildland Fire Questions	
Where is the fire?	
Who is the Incident Commander?	
Incident Commanders Phone Number?	
Is there an Incident Command Post set up?	
Where is it?	
Do you need an NVE rep onsite?	
Can our crews get into the black?	
What PPE is needed?	
Are poles actively burning?	

3.0 Wildland Fire Notification Route

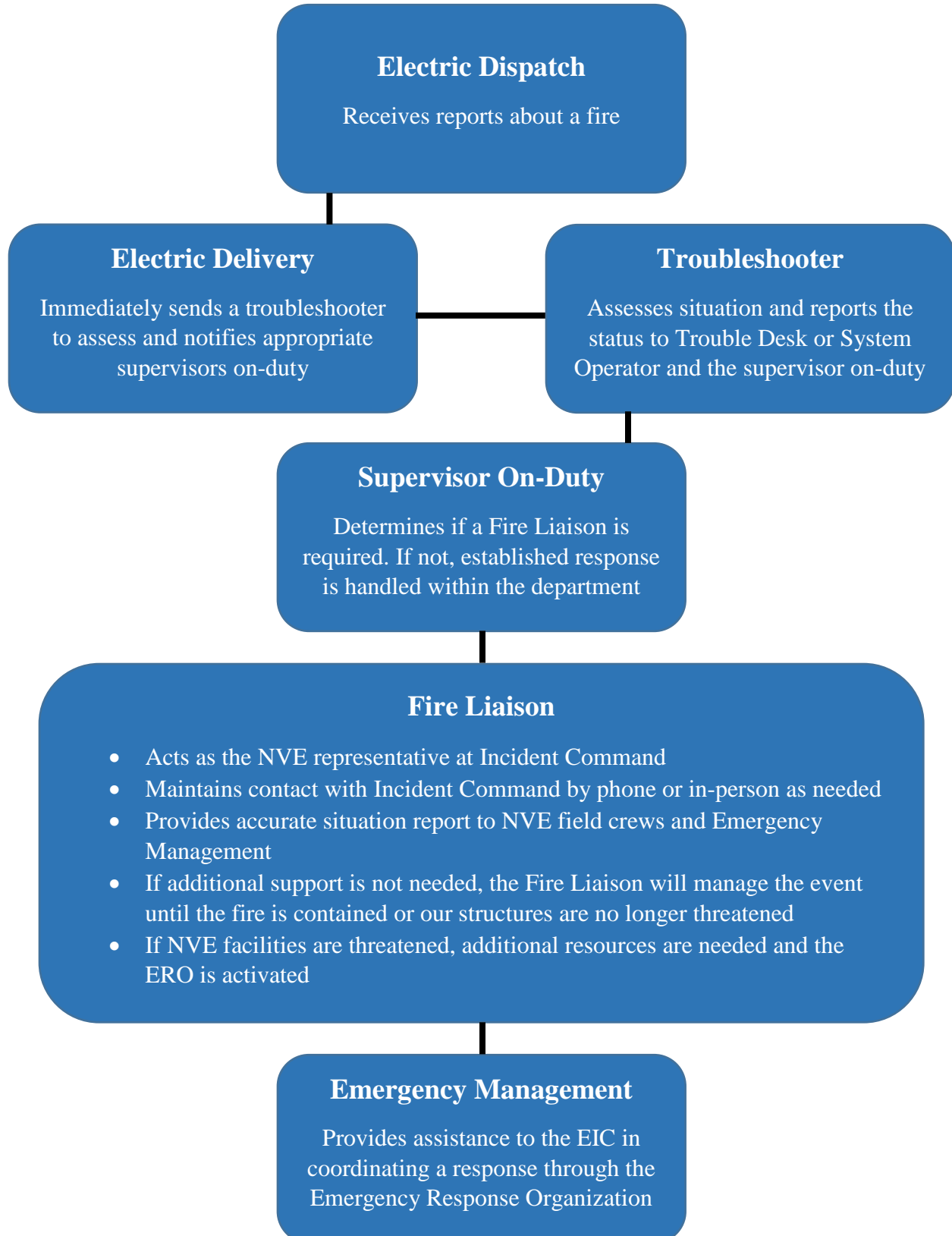

Wildland Fire Notification Route – Gas Delivery

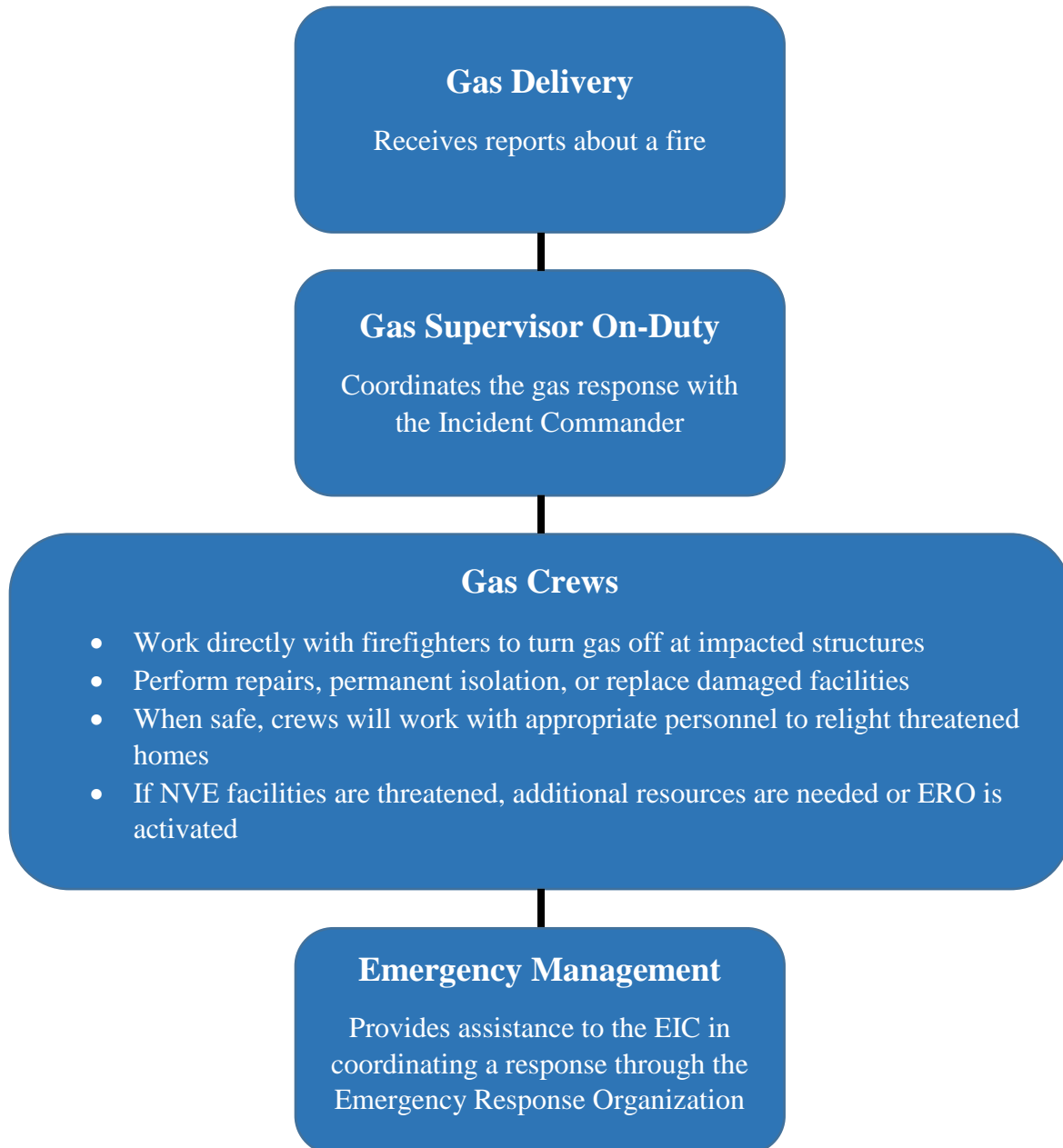

4.0 Personal Protective Equipment

4.1 Inventory List for Wildland Fire Bags

Wildland Fire Gear are “NON STOCK” and include:

- 1 each – Nomex IIIA Yellow Brush Shirt
- 1 each = Nomex IIIA Yellow Brush Pants (Over Pant)
- 1 each - Neck Protector
- 1 each – New Generation Fire Shelter (*Shelter must have BLUE casing, if Yellow please return*).
- 1 each – Web Belt for the fire shelter

4.2 Additional Equipment for Wildland Fire Bag

YOU ARE RESPONSIBLE FOR ADDING THE FOLLOWING ITEMS TO YOUR FIRE GEAR BAG!

Wildland Fire Gear “STOCK ITEMS” from the warehouse include:

- 1 pair – Leather Work gloves (always keep an extra pair in the bag).
- 1 pair goggles – Wildcat Goggles are now in stock in Clear, Smoke, and Amber
- 1 each – Hardhat (*Recommend an additional hardhat with Neck Protector and Goggles already attached*).
- 1 each – Respirator/Dust Mask (*recommend having something available for working in dust hazard environment*).
- Extra socks, cotton tee shirt and bandana are recommended but optional.

4.3 Fire Locker Supplies at 1 Ohm

There are extra PPE in the fire locker located at 1 Ohm if additional yellows are needed for crews going out into the incident. There are also UHF radios in that same locker for crews heading out to the scene. When arriving at the Command Post, ask the Incident Commander/Operations Section Chief to have your radio cloned to match their frequencies.



5.0 Pre-Trip Fire Pumper Inspection Form

Driver must inspect the assigned vehicle before the vehicle is moved

Driver Name:	Vehicle Unit Number:	License Number:	Odometer:
---------------------	-----------------------------	------------------------	------------------

Notify dispatch when leaving the yard and when reporting on-site at the fire.
 Report to the incident commander or onsite supervisor and await permission to enter the fire area proceed as directed.
 Report to the incident commander or onsite supervisor when leaving the fire area.

Ok	Restock	The items listed below must be on hand prior to reporting to a fire
		Verify utilities/wildland fire contact list & radio list are available
		Check for radio (truck mounted or hand held)
		Personal PPE available (nomex jacket, pants, balaclava, goggles, gloves, shelter, hardhat)
		Water cooler filled
		Fuel and oil level in both truck and pump
		Water level in pumper holding tank
		Fire nozzles and fire gel as needed
		Verify pump is primed (test operationally prior to leaving yard/ pump off when in transit)
		Indian can/ shovel/ axe or polaski
Ok	Repair	If repairs are needed please contact fleet services and return this form
		Any fluid leaks under the vehicle
		Body condition/company logos/numbers clean and present/dents/or scratches
		Windshield clean/not cracked or chipped
		Windshield wipers not cracked or worn/torn
		Headlights function both hi/low beam not cracked/faded
		Turn signals function/clean both front and rear
		Brake lights function including third brake light
		Reverse lights/back up camera/sensors clean and working properly (if equipped)



		Gas cap present and tight
		Cargo in or on vehicle properly secured
		Tire tread/sidewalls showing damage/dry rot/cracks/wheels/lug nuts inspected
		Proper tire inflation (see inside of driver's door for air pressure amount)
		Engine oil level check (between add and full)
		Fan belt/hoses no obvious damage/loose
		Coolant level between add and full
		Emergency equipment (fire extinguisher/first aid kit/2 orange cones/chocks)
		Mirrors properly adjusted and clean
		Seatbelt functions properly and not worn
		Registration/proof of insurance/accident booklet/amber light permit(if required)
		Circle of safety preformed prior to moving vehicle

You must wear your PPE, including nomex shirt and pants when reporting to the incident commander and when working in the fire area!

Notes:

I have personally inspected the vehicle above and have found it to be in safe operating condition as listed above.

Signature: _____ Date: _____

6.0 Fire Pumper Pre-Trip Checklist

- Take one (1) of the “Fire Truck Only” radio’s from Dan Clancy’s office for communication with the fire agencies on-site.
- Take two (2) of the wire pull radios with microphones from the Tool Room for communication with Sierra’s personnel, Dispatch, etc.
- Take the red, PPE bag from the tool room that contains the Nomex, shelter, etc.
- Take your own personnel PPE, including a hard hat, gloves, and clear safety glasses.
- Fill water cooler and ice chest.
- Check fuel and oil in both the pump and truck. Check water level in pumper holding tank.
- Notify Dispatch when leaving the yard and when reporting on-site at the fire location.
- Report to the Incident Commander and wait to enter the fire area until given permission. If the company has an on-site supervisor at the Incident Command, report to that supervisor and proceed as directed.
- Report to Incident Commander or on-site supervisor when leaving the fire area.

YOU MUST WEAR YOUR PPE, INCLUDING NOMEX SHIRT AND PANTS, WHEN REPORTING TO THE INCIDENT COMMANDER AND WHEN WORKING IN THE FIRE AREA!

7.0 PRE-SEASON ACTIVITIES

The following provides guidelines by area for pre-fire season preparedness. Each area should consider starting these annual activities no later than April 1, with a target completion date of June 1. In some cases, where wildland fire season is forecasted to start earlier, these activities may be implemented in March.

7.1 Emergency Management

Emergency management will perform the following actions annually each spring:

- Coordinate with state and federal fire resources (*e.g. NDF, USFS, BLM*) on lessons learned from the previous wildland fire season, and implement improvements to public/private sector coordination, when applicable.
- Communicate wildland fire season forecasts to company personnel.
- Facilitate a wildland fire season guideline review and update session.

7.2 Field Operations

The following pre-fire season tasks are recommended for field operations managers:

- Participate in NV Energy wildland fire guideline review and update sessions.
- Verify locations and check conditions of specialized equipment, such as tankers and fire pumper trailers.

- Review operating procedures for specialized equipment with personnel.
- Check with local rental companies about access to “spare” water tankers.
- Ensure vehicles working in or around fire potential areas are equipped with a shovel, Pulaski/axe, and a water can.
- Have mechanics check under all vehicles being serviced for accumulating grass or weeds.
- Review available stock and locations of PPE’s related to wildland fire season (*e.g. masks, fire shelters*).
- Review system operations Fire Mode patrol and line-testing policies with personnel (*General Review*).
- Provide wildland fire training related to safety equipment, tools and PPE’s (*Bi-annual/New Hire*).
- Coordinate with emergency management on wildland fire season public/private sector meetings and exercises.

7.3 GIS Support

The following pre-fire season tasks are recommended for GIS support personnel:

- Participate in wildland fire guideline review and update sessions.
- Implement improvements to fire season maps based on the previous year’s lessons learned.
- Update distribution lists for fire maps.

7.4 ESCC – Electric Dispatch

The following pre-fire season tasks are recommended for the regional dispatch manager, and dispatch supervisors:

- Participate in wildland fire procedural guideline review and update sessions.
- Review the procedural guidelines with dispatch personnel and provide training, where applicable.
- Review, update and communicate changes to system operations line-testing policies in coordination with grid operations.
- Update distribution/ notification lists with current contact numbers and emails.

7.5 Safety

The following pre-fire season tasks are recommended for safety managers:

- Participate in wildland fire procedural guideline review and update sessions.
- Review health and safety practices and apply lessons learned from the prior wildland fire season.
- Assist/participate in wildland fire season training with field personnel. Curriculum and audience will be determined on an annual basis by Emergency Management and Operations personnel.
- Review system operations Fire Mode patrolling and line-testing policies with personnel (*general review*).

7.6 Substation Operations

The following pre-fire season tasks are recommended for substation operations managers:

- Participate in wildland fire procedural guideline review and update sessions.
- Review operating procedures for specialized equipment with personnel.

7.7 Substation/Transmission Civil Construction

The following pre-fire season tasks are recommended for general construction managers:

- Participate in wildland fire procedural guideline review and update sessions.
- Review operating procedures for specialized equipment and appropriate training of personnel.

7.8 Fleet Operations

The following pre-fire season tasks are recommended for fleet operations managers:

- Participate in wildland fire procedural guideline review and update sessions.
- Ensure operability for specialized fire related equipment and appropriate training of personnel.

7.9 Materials Operations

The following pre-fire season tasks are recommended for materials operations managers:

- Participate in wildland fire procedural guideline review and update sessions.
- Review fire related inventory levels and vendor availability.
- Prepare mobile warehouse supplies and training of personnel for response to fire areas.

APPENDIX A4
Blasting Plan

Blasting Plan
Bordertown to California 120 kV Transmission Line
Construction, Operation, and Maintenance (COM) Plan

Prepared for:

NV Energy
6100 Neil Road
Reno, Nevada 89511

Prepared by:

Stantec Consulting Services Inc.
6995 Sierra Center Parkway
Reno, Nevada 89511

August 2020

Table of Contents

1.0	INTRODUCTION	1
1.1	Purpose and Need for Blasting Plan	1
1.2	Regulatory Overview.....	1
2.0	NEED FOR BLASTING	2
2.1	Determination of Blasting Sites	2
3.0	BLASTING PROCEDURES	3
3.1	Overview of Blasting Principles	3
3.2	Blast Design.....	3
3.2.1	Borehole Diameter	4
3.2.2	Burden	4
3.2.3	Borehole Spacing	4
3.2.4	Explosive Column.....	4
3.3	Materials Used	4
3.4	Safety Measures.....	4
3.4.1	Storage Requirements.....	5
3.4.2	Personal Safety, Protection of Property, and Notification.....	5
3.4.3	Fire Safety	6
3.4.4	Transportation of Explosives	6
3.5	Design Features	7
4.0	REFERENCES	8

LIST OF ABBREVIATIONS

ATF	Bureau of Alcohol, Tobacco, Firearms, and Explosives
COM	Construction, Operations, and Maintenance
ETI	Explosives Technology International
kV	Kilovolt
Plan	Blasting Plan
Project	Bordertown to California 120 Kilovolt Transmission Line Project
U.S.	United States
U.S. DOT	U.S. Department of Transportation
USFS	U.S. Forest Service



1.0 INTRODUCTION

NV Energy and its contractors will construct the Bordertown to California 120 Kilovolt (kV) Transmission Line Project (Project) in compliance with all federal, state, and local regulations as well as the National Environmental Policy Act, the Environmental Impact Statement and Final Record of Decision, the United States (U.S.) Forest Service (USFS) Special Use Permit, and all other applicable permits. The Project area is in Washoe County, Nevada, and Sierra County, California, west and northwest of the city of Reno, Nevada. The northern boundary of the Project area is near Bordertown, Nevada, and U.S. Highway 395 and the southern boundary is near Interstate 80 between Verdi, Nevada, and Mogul, Nevada. The western boundary is roughly parallel with the California state line and the eastern boundary extends to the Peavine area generally east of Peavine Peak. The constructed 120 kV overhead transmission line will be approximately 11.9 miles long and will run between the existing Bordertown and California substations in Sierra County, California.

This Blasting Plan (Plan) is part of NV Energy's compliance obligation and is appended to the Construction, Operations, and Maintenance (COM) Plan. This Plan provides guidance to construction managers, environmental inspectors, and regulatory agencies for reducing the impacts and risks associated with the storage and use of explosive materials during Project construction. The Plan lists blasting closures zones (when and where blasting is restricted or not allowed) for sensitive wildlife habitats. It will be implemented throughout the construction period.

1.1 PURPOSE AND NEED FOR BLASTING PLAN

The purpose of the Plan is to provide construction crews, environmental compliance inspectors, and agency monitors with Project-specific information concerning blasting procedures, including the safe use and storage of explosives. The primary objective of this Plan is to prevent adverse impacts to human health and safety, property, and the environment that could potentially result from the use of explosives during Project construction.

1.2 REGULATORY OVERVIEW

The federal Occupational Safety and Health Administration and numerous state and local jurisdictions regulate the use of explosives. The U.S. Department of Justice, Bureau of Alcohol, Tobacco, Firearms, and Explosives (ATF) regulates explosives storage and commerce under the Organized Crime Control Act of 1970, Title XI (Public Law 91-452). The major provisions of this federal law are discussed in ATF publication P 5400.7 ATF-Federal Explosives Law and Regulations (2012). Applicable provisions are included by reference as part of the Plan. State and local laws governing explosives may be more restrictive than the ATF regulations. Persons responsible for implementing the Plan must comply with the most stringent provisions of applicable federal, state, and local laws that pertain to explosives. Failure to comply with such laws could result in substantial financial penalty and/or imprisonment.

2.0 NEED FOR BLASTING

Blasting is likely to be used as an alternate excavation method for pole site foundations in certain areas as geological and site conditions require. Additionally, blasting (i.e., explosives) may be used for new temporary roads where rocks cannot be removed with heavy equipment. Blasting will be used only in areas where traditional excavation and earth moving equipment and practices are unable to accomplish the excavation. In general, it is expected that blasting will occur mainly in remote, sparsely populated areas, well away from residences and other structures that could sustain blast-related damage. However, there is the potential for blasting to occur near sensitive receptors (i.e., occupied residences) and will be limited to Monday through Friday from 7:00 AM to 7:00 PM.

2.1 DETERMINATION OF BLASTING SITES

Blasting will be limited primarily to those areas underlain by hard-to-excavate bedrock near the surface or in areas containing large boulders. A geotechnical investigation was completed in 2019 at locations where foundations for the structures were known to be needed due to land constraints. All of these locations were situated on private land and no blasting was expected at these locations. In addition to the geotechnical activities already completed, once a contractor is hired for the Project, they will review the route and soil conditions to determine if blasting shall be needed. Upon completion of this review and if a need for further geotechnical surveys are needed on USFS land, NV Energy and its construction contractor(s) will provide a list of potential blasting locations and corresponding figures to support this Plan.

3.0 BLASTING PROCEDURES

The blasting contractor will use current and professionally accepted methods, products, and procedures to maximize safety during blasting operations. Blasting procedures will be carried out according to, and in compliance with, applicable laws (see Section 1.2). Blasting activities will be conducted by a qualified, experienced, and licensed blasting contractor and will be closely monitored by the environmental field inspector and quality assurance inspector.

3.1 OVERVIEW OF BLASTING PRINCIPLES

Blasting procedures will be conducted according to the following four basic principles:

1. The blast will produce fractured rock of appropriate dimensions;
2. The blast will prevent/minimize production of flyrock and air blast hazards;
3. The blast will minimize peak particle velocities; and
4. The blast will be scaled/sized to minimize overblasting, which can result in excessive excavation and handling of excavated material, and increased drilling, excavation, and backfill costs.

In general, the process of rock fragmentation and displacement following detonation occurs in four phases. The first phase is detonation, which involves the conversion of fuels and oxidizers into high-pressure and high-temperature gases that initiate a shock wave. The next phase is the propagation of the initial shock wave and the production of a stress wave throughout the rock mass. Phase three results in the extension of the blast hole, fracturing, and displacement of broken materials. In this phase, gases produced during the blast are often vented to the surface. The fourth and final phase of the blasting sequence involves mass movement of rock with some additional fragmentation resulting from in-flight rock collisions. For this Project, blasting mats will be used to prevent or reduce the number of rock particles thrown into the air following detonation.

The blasting process produces different zones of damage around the blast hole. The zones of damage are generally referred to as Zones 1 through 5, with Zone 1 being located closest to the borehole and Zone 5 being located furthest from the borehole. In Zone 1, rocks are crushed and pulverized. Rock damage from the blast decreases with distance away from the borehole to the point where, in Zone 5, rocks are caused to vibrate due to the seismic waves from the blast but are undamaged.

3.2 BLAST DESIGN

Major factors considered during blast design include borehole diameter, burden, borehole spacing, and configuration of the explosive column. These factors, which will vary at individual blast sites, are defined and discussed briefly below.

3.2.1 Borehole Diameter

Smaller diameter boreholes used for blasting purposes typically provide better distribution of explosive energy and control of ground vibrations than do larger diameter boreholes. The borehole diameters for this Project are anticipated to range from one to three inches.

3.2.2 Burden

Burden refers to the specific distance between drilled boreholes or between a loaded borehole (one which has been filled with explosives for blasting purposes) and the nearest free face of exposed rock. There are two types of burden: drilled burden and blasted burden. Drilled burden is the distance between rows of drilled boreholes. Blasted burden is the distance between a loaded borehole and the nearest free face of exposed rock. A drilled burden pattern of six by eight inches indicates a burden of six inches between rows and eight inches between boreholes in a row. Insufficient burden generally results in excessive flyrock from the blast. Excess burden results in poor fragmentation and increased ground vibration from the blast.

3.2.3 Borehole Spacing

The spacing between boreholes is a function of the desired burden. Consecutive boreholes are generally placed so that damage Zone 4 or 5 of adjacent boreholes overlap for maximum fracturing. The distance between boreholes for this Project will depend on the rock characteristics and will typically range from approximately five to 10 feet. Therefore, Zone 5 (undamaged rock) for each borehole is expected to be less than 10 feet from said borehole.

3.2.4 Explosive Column

Detailed specifications on the explosive column will be developed by the blasting contractor based on site-specific geotechnical assessment provided to NV Energy or their geotechnical engineering contractor.

3.3 MATERIALS USED

Specific materials needed for blasting operations will be identified by the blasting contractor. These materials will be included on the hazardous materials list for the Project, and their use and storage will comply with applicable federal, state, and local laws.

3.4 SAFETY MEASURES

Safe storage and use of explosive materials will be a top priority during the construction period. The following safety measures are intended to prevent theft and/or vandalism of the explosive materials, protect them against fire, and to prevent personal injury and property damage. These measures are intended as general guidelines. For specific information on blasting safety, refer to Chapters 25 and 27 and Appendix B of the Blasters' Handbook (ETI, 1980), and other pertinent regulations. Persons responsible for using, storing, and transporting explosives should be knowledgeable of the information provided therein. Protection of environmental resources is discussed in Section 3.5.



3.4.1 Storage Requirements

Many federal, state, and local agencies have laws pertaining to the storage of explosives. According to these laws, explosives must be stored in an approved structure (magazine). Magazines must be kept cool, dry, and well ventilated. Additional storage facility requirements concerning construction specifications and location are defined for various classes of explosive materials in the ATF publication ATF P 5400.7 (2012).

At a minimum, explosives storage facilities will be bullet-resistant, weather-resistant, theft-resistant, and fire-resistant. Magazine sites will be located in remote (out-of-site) areas with restricted access and will be properly labeled and signed. Detonators will be stored separately from other explosive materials. The most stringent spacing between individual magazines will be determined according to the guidelines contained in the ATF publication or state or local explosive storage regulations. Both the quantity and duration of on-site explosives storage will be minimized.

NV Energy's construction contractor(s) will provide the ATF's Industry Operations in the Reno, Nevada Field Office, with a list of dates and locations for the explosives and blasting agent storage facilities to be used on the Project at least 14 days before the establishment of such storage facilities.

The blasting contractor will handle and dispose of dynamite storage boxes in accordance with relevant federal, state, and local laws.

3.4.2 Personal Safety, Protection of Property, and Notification

Ensuring the safety of persons and property in and around blasting areas and magazine sites requires proper safety training, supervision by experienced personnel, use of safety equipment, good communication, adherence to notification procedures (including pre-blast and emergency notification), and awareness. All persons responsible for handling explosives, and persons present in and around blasting sites, will be fully informed and trained in applicable safety precautions and procedures.

A signaling system will be used to alert persons of an impending blast. The signaling system will be comprised of the following components:

- A warning signal: Five minutes prior to the blasting signal, a one-minute series of long audible signals will be sounded at the blast site;
- A blasting signal: One minute prior to a blast, a series of short, audible signals will be sounded at the blast site; and
- An all-clear signal: Following inspection of the blast area, a prolonged audible signal will be sounded at the blast site.

Signs explaining the signaling protocol will be posted at the construction staging areas and other appropriate locations. Before blasting, the blasting supervisor will make sure that the blasting area is clear and access in and around the blasting area will be restricted to prevent curious or unwitting persons from entering the blasting area. Landowners will be notified well in advance of the scheduled blast and will be informed of the blast signaling protocol. Special attention will be given

to preventing potential hazards in the blasting area resulting from flying rock, destabilized walls/structures, presence of low flying aircraft, dispersion of smoke and gases, etc. For this Project, blasting mats will be used to prevent or reduce the number of rock particles thrown into the air following detonation.

Blasting for this Project will not entail large blasts and therefore monitoring of blast vibration and airblast is not recommended as a general procedure for all blasts. However, if any complaints attributed to the blasting are received from residents, appropriate steps shall be taken to monitor blast vibration and airblast to determine the actual levels experienced. Also, at that time, limits will be established for blast vibration and airblast that will assure that no damage will occur to structures and will minimize the annoyance caused by blasting to the affected residents.

Following detonation, the blasting area will be inspected for un-detonated or misfired explosives. The blasting area will also be inspected for hazards such as falling rock and rock slides. Once the area has been inspected and these issues have been addressed, the “all-clear” signal will sound, and persons will be able to safely re-enter the blast zone. Additional safety precautions will be developed to address site specific conditions at the time of the blast.

If an electrical storm approaches during blasting preparation, the blasting contractor will follow the appropriate regulatory procedures and delay or reschedule the blast, as necessary.

3.4.3 Fire Safety

The presence of explosive materials on the Project site could potentially increase the risk of fire during construction. Special precautions will be taken to minimize this risk, including but not limited to:

- Prohibiting ignition devices within 50 feet of an explosives storage area;
- Properly maintaining magazine sites so that they are clear of fuels and combustible materials, are well ventilated, and are fire-resistant;
- Protecting magazines from wildfires that could occur in the immediate area;
- Posting fire suppression personnel at the blast site during high fire danger periods (Fire Condition Class 4 or as required by the USFS); and
- Prohibiting blasting during extreme fire danger periods (Fire Condition Class 5 unless special fire prevention procedures are approved by the USFS).

3.4.4 Transportation of Explosives

Transportation of explosives will comply with all applicable federal, state, and local laws including Title 49 of the Code of Federal Regulations, Chapter III. These regulations are administered by the U.S. Department of Transportation and govern the packaging, labeling, materials compatibility, driver qualifications, and safety of transported explosives. In general, these regulations require that vehicles carrying explosive materials must be well maintained, properly marked with placards, and have a non-sparking floor. Materials in contact with the explosives will be non-sparking, and the load will be covered with a fire and water-resistant tarpaulin. Vehicles also must be equipped with fire extinguishers and a copy of the Emergency Response Guidebook

(U.S. DOT, 2016). Every effort will be made to minimize transportation of explosives through congested or heavily populated areas.

Prior to loading a vehicle which is appropriate for carrying explosives, the vehicle must be fully fueled and inspected to ensure its safe operation. Refueling of vehicles carrying explosives will be avoided. Smoking will be prohibited during the loading, transporting, or unloading of explosives. In addition, the following specific restrictions apply to the transport of other items in vehicles carrying explosives:

- Tools may be carried in the vehicle, but not in the cargo compartment;
- Detonation devices can, in some cases, be carried in the same vehicle as the explosives, but they must be stored in specially-constructed compartments;
- Batteries and firearms must never be carried in a vehicle with explosives; and
- Vehicle drivers must comply with the laws related to the materials being transported.

Vehicles carrying explosives will not be parked or left unattended except in designated parking areas with approval of the state fire marshal. When traveling, vehicles carrying explosives will avoid congested areas to the maximum extent possible.

3.5 DESIGN FEATURES

Blasting has the potential to cause adverse environmental impacts to wildlife and create noise disturbances. Implementing the practices/procedures listed below will help mitigate these impacts.

- Near sensitive receptors (i.e., occupied residences), noise-generating activities (e.g., blasting) will be limited to Monday through Friday from 7:00 a.m. to 7:00 p.m. Otherwise, work may occur 12 hours per day any day of the week;
- To reduce potential disturbance to migratory birds, construction activities will occur outside of the typical avian breeding season (April 1 to July 31). If construction activities cannot be avoided during this time period, surveys will be conducted immediately prior to construction to locate active nesting areas.
- To avoid impacts to wintering mule deer, construction will not occur from November 25 through May 25 within areas mapped as crucial winter or winter-spring high deer use, including the Mitchell Canyon Deer Management Area. However, areas of mapped crucial winter range within and immediately surrounding the Bordertown Substation expansion area would be cleared and fenced outside of this timeframe, allowing construction activities to occur within this area during the restricted timeframe. Non-ground disturbing activities, such as surveying, staking, or resource driven activities (e.g., cultural surveys, biological surveys), may occur within this time frame.

4.0 REFERENCES

- Explosives Technology International (ETI). 1980. Blasters' Handbook, 175th Anniversary Edition. E.I. du Pont de Nemours & Co., Inc. Wilmington, DE.
- U.S. Department of Justice, Bureau of Alcohol, Tobacco, Firearms, and Explosives (ATF). 2012. ATF-Federal Explosives Law and Regulations (ATF P 5400.7).
- U.S. Department of Transportation (U.S. DOT). 2016. Emergency Response Guidebook: Guidebook Intended for use by First Responders during the Initial Phase of a Transportation Incident Involving Dangerous Goods/Hazardous Materials.

APPENDIX B1
Transportation Management Plan

Transportation Management Plan Bordertown to California 120 kV Transmission Line Construction, Operation, and Maintenance (COM) Plan

Prepared for:

NV Energy
6100 Neil Road
Reno, Nevada 89511

Prepared by:

Stantec Consulting Services Inc.
6995 Sierra Center Parkway
Reno, Nevada 89511

August 2020

Table of Contents

1.0	INTRODUCTION	1
2.0	REGULATORY OVERVIEW	2
3.0	ACCESS TO PROJECT RIGHT-OF-WAY	3
3.1	Existing Access Roads.....	3
3.1.1	Design Features.....	3
3.2	New Temporary Access Roads.....	5
3.2.1	Design Features.....	5
4.0	GENERAL CONSIDERATIONS	7
5.0	POST-CONSTRUCTION RECLAMATION	8
6.0	TRANSPORTATION MANAGEMENT PRACTICES	9
7.0	REFERENCES	10

List of Tables

Table 3-1	Existing Road Access Use for Project Construction	4
-----------	---	---

List of Figures

Figure 1	Existing Road Access for Project Construction
----------	---

LIST OF ABBREVIATIONS

AQ	Air Quality
COM	Construction, Operations, and Maintenance
kV	Kilovolt
NFS	National Forest System
NW	Noxious Weeds
Plan	Transportation Management Plan
Project	Bordertown to California 120 Kilovolt Transmission Line Project
ROW	right-of-way
RT	Recreation/Roads/Transportation
SV	Plants and Sensitive Plan Communities
U.S.	United States
USFS	United States Forest Service
VG	Vegetation



1.0 INTRODUCTION

NV Energy and its contractors will construct the Bordertown to California 120 Kilovolt (kV) Transmission Line Project (Project) in compliance with all federal, state, and local regulations as well as the National Environmental Policy Act, the Environmental Impact Statement and Final Record of Decision, the United States (U.S.) Forest Service (USFS) Special Use Permit, and all other applicable permits. The Project area is in Washoe County, Nevada, and Sierra County, California, west and northwest of the city of Reno, Nevada. The northern boundary of the Project area is near Bordertown, Nevada, and U.S. Highway 395 and the southern boundary is near Interstate 80 between Verdi, Nevada, and Mogul, Nevada. The western boundary is roughly parallel with the California state line and the eastern boundary extends to the Peavine area generally east of Peavine Peak. The constructed 120 kV overhead transmission line will be approximately 11.9 miles long and will run between the existing Bordertown and California substations in Sierra County, California.

This Transportation Management Plan (Plan) is part of NV Energy's compliance obligation and is appended to the Construction, Operations, and Maintenance (COM) Plan. This Plan provides guidance to construction managers, environmental inspectors, and regulatory agencies with a detailed description of the access and transportation-related activities associated with the construction, operation, and maintenance of the Project. The measures included in this Plan are intended to mitigate Project effects on environmental resources associated with roads, traffic, travel, and safety.

2.0 REGULATORY OVERVIEW

Several agencies have jurisdiction over the existing access roads to be used for the Project and over transportation-related components of the Project. These include the USFS, the Bureau of Land Management, Nevada Department of Transportation, and law enforcement and road departments in Washoe County, Nevada and Sierra County, California.

Other permits and approvals not directly related to transportation could affect the construction, use, and/or maintenance of roads in certain areas. Persons responsible for Project transportation activities must be familiar with all relevant sections of this Plan.

3.0 ACCESS TO PROJECT RIGHT-OF-WAY

Access to the transmission line right-of-way (ROW)/easement will be needed for Project construction, operation, and maintenance activities. One or more criteria listed below will be used to access the ROW/easement and transmission tower locations.

3.1 EXISTING ACCESS ROADS

Existing roads will be used for construction and maintenance access as much as possible. Access roads that will not require improvement for access are depicted on Figure 1 of this Plan.

Some existing roads will require improvements and will be widened up to 30 feet, including cut and fill slopes to accommodate construction equipment. Access roads that will require temporary widening are depicted on Figure 1 of this Plan.

Table 3-1 describes existing access roads that will be used during the Project and which will require improvements.

3.1.1 Design Features

NV Energy will comply with the design features listed below for existing access roads:

Noxious Weeds (NW) 1. Noxious weeds occurring on either the Nevada or California State list will be mapped and the full extent of the population will be treated prior to and following construction. Inventory and treatment areas will extend 100 feet from the ROW and all ground disturbed by Project activities. Existing access roads proposed for widening are included in all ground disturbance activities.

Water Resources and Soil (WA) 8. Improvements to any existing road crossing will be designed to minimize surface disturbance.

Plants and Sensitive Plant Communities (SV) 5. Where existing roads are used for travel to the Project site (but not widened), any road maintenance within 100 feet from special status plant populations will focus on avoiding impacts. A permanent physical barrier, such as lining the roads with rock or fencing the road corridor, will be constructed to prohibit vehicle access to sensitive plant populations and contain travel within the existing road corridor.

Recreation/Roads/Transportation (RT) 1. The use of any roads or trails will require compliance with the Carson Ranger District Motor Vehicle Use Map, including any restrictions for seasonal use.

Table 3-1 Existing Road Access Use for Project Construction

Road ID ¹	Jurisdiction	Improvement (Yes/No)	Type of Improvement	Seasonal Restrictions	Miles
21514	National Forest System (NFS)	Yes	Temporary widening (up to 30 feet)	Open Year-Round	0.36
41192	Private	No	Routine Road Maintenance	Seasonal Restrictions ²	0.31
	NFS	No	Routine Road Maintenance	Seasonal Restrictions ²	2.60
41419	Private	Yes	Temporary widening (up to 30 feet)	Open Year-Round	0.10
	NFS	Yes	Temporary widening (up to 30 feet)	Open Year-Round	2.25
41643	NFS	Yes	Temporary widening (up to 30 feet)	Seasonal Restrictions ²	0.82
41668	NFS	No	Routine Road Maintenance	Open Year-Round	0.88
	NFS	Yes	Temporary widening (up to 30 feet)	Open Year-Round	0.91
41669	Private	Yes	Temporary widening (up to 30 feet)	Open Year-Round	0.32
	NFS	Yes	Temporary widening (up to 30 feet)	Open Year-Round	1.57
41735	NFS	No	Routine Road Maintenance	Open Year-Round	0.07
	NFS	Yes	Temporary widening (up to 30 feet)	Open Year-Round	0.79
Feenune Road	Private	Yes	Temporary widening (up to 30 feet)	Open Year-Round	0.88
Green Gulch Road	Private	Yes	Temporary widening (up to 30 feet)	Open Year-Round	0.36
River Pines Road	Private	Yes	Temporary widening (up to 30 feet)	Open Year-Round	1.21
Dog-Long Valley Road 31002	Private	No	Routine Road Maintenance	Open Year-Round	2.50
Peavine Peak Road 41641	Washoe County/Private	No	Routine Road Maintenance	Open Year-Round	4.23
	NFS	No	Routine Road Maintenance	Open Year-Round	1.92
Unnamed Dirt Roads	Private	Yes	Temporary widening (up to 30 feet)	Open Year-Round	5.93
Total					27.94

¹ Roads are displayed on Figure 1 of this Plan.

² Seasonal restrictions occur from April 1 to November 18.



3.2 NEW TEMPORARY ACCESS ROADS

New temporary access roads (i.e., centerline travel road and spur roads) will be constructed to pole sites, transmission wire setup sites, and staging areas when there are no existing roads available.

Access roads will be 30 feet wide and located within the 300- to 600-foot-wide corridor (variable-width corridor). The variable-width corridor is centered on the transmission line and measures 300 feet wide where slopes are 10 percent or less, and 600 feet wide where slopes are greater than 10 percent. Temporary roads will be constructed primarily by mowing or masticating vegetation in a manner that leaves root systems intact to encourage regrowth and minimize soil erosion. Whole tree removal will be required where new access roads cross forested areas. Rocks or other obstructions will be bladed. If rocks cannot be removed with heavy equipment, explosives may be used in accordance with the Blasting Plan (COM Plan Appendix A4). While new access roads wider than 30 feet are not expected, occasional widening beyond 30 feet may be necessary in areas where extensive blading and side cuts are required.

NV Energy does not propose to retain any temporary access roads for operation and maintenance of the new transmission line. Following construction, all temporary access roads would be recontoured and stabilized by seeding, mulching, placement of erosion control fabric, and installing erosion control features such as water bars. Vehicle access for transmission line maintenance is expected to be rare as the poles would be made of fire resistant metal. Access would be necessary approximately every 10 years for close visual inspections and tree removal within the line clearance area. When future vehicle access is needed for maintenance or tree removal, the existing National Environmental Policy Act analysis would be reviewed, and access may be approved based upon the level of proposed new disturbance and/or the change in environmental conditions.

3.2.1 Design Features

NV Energy will comply with the design features listed below for new temporary access roads:

- NW 1. Noxious weeds occurring on either the Nevada or California State list will be mapped and the full extent of the population will be treated prior to and following construction. Inventory and treatment areas will extend 100 feet from the ROW and all ground disturbed by project activities. Construction access roads proposed for widening are included in all ground disturbance activities.
- NW 2. Monitoring and continued treatment in areas that were treated prior to construction will commence the first full growing season after project implementation. Weed treatment will continue until disturbed areas are successfully restored (see restoration criteria). Weed treatment will continue during maintenance activities and within the ROW.
- NW 6. Construction of access roads will not occur in areas heavily infested with noxious or invasive weeds.
- SV 2. Prior to construction, once access roads and pole locations are known, the following tasks will be completed for areas where surface disturbance is planned:



- a. Pre-construction surveys for jaw-leaf lupine (*Lupinus malacophyllus*), andesite popcorn flower (*Plagiobothrys glomeratus*), and moonwort ferns (*Botrychium spp.*);
 - b. Mapping and flagging of sensitive plant species, wetland areas, and noxious weeds; and
 - c. Noxious weed infestations will be treated according to design features NW1 and NW 2.
- SV 3. There will be no new access roads or widening of existing roads for construction access through meadows. This measure will also protect potential habitat for special status plant populations that are found in wetland and meadow habitats, such as Dog Valley ivesia.
- SV 6. Construction of new access roads (i.e., spur roads and centerline travel roads) and widening of existing roads and motorized trails will not occur within 500 meters (1,640 feet) of populations of Dog Valley ivesia and Webber ivesia (*Ivesia webberi*) occurring on NFS land. Allowable maintenance of roads within these habitat areas that do not require widening include blading and installation of erosion control measures. Construction of new temporary access roads and widening of existing roads and motorized trails will not occur within 200 feet of other special status plant populations that occur on NFS land. Within these buffer distances, travel and road maintenance on existing roads and motorized trails may be permitted but road improvements including widening of the existing travelled way are prohibited.
- SV 8. Access roads will not be constructed within potential habitat of Webber ivesia. Potential habitat includes low sage plant communities with specific habitat attributes: presence of a rocky pavement surface, presence of an argillic soil horizon, plant community composition and presence of associated plants, topographic position of the site, and, known elevation range. Areas defined as potential habitat will require the 500-meter buffer.
- Vegetation (VG) 5. Where removal of vegetation other than trees is unavoidable, the vegetation will be cut at ground level to preserve the root structure and allow for potential sprouting.
- Wildlife and Sensitive Wildlife Species (WL) 10. To limit the potential for impacts to aquatic resources, particularly to Lahontan cutthroat trout (*Onchorhynchus henshawi*), pole sites or roads will not be placed within the 100-year floodplain in Dog Creek, Bull Ranch Creek, and the Truckee River. During construction, no soil disturbing activities will occur within the 100-year floodplain of these streams.
- Air Quality (AQ) 1. Vehicle and equipment speeds will be limited to 20 miles per hour on unpaved roads and on the ROW/easement.
- RT 2. All new temporary access roads and all improvements to existing roads will comply with: 1) The Forest Service National Supplements to the FP-03 (USFS, 2010); 2) the USFS Road Construction Handbooks (FSH 7709.56 and FSH 7709.57); and, 3) the Toiyabe Forest Plan, as amended (USFS 1986).
- RT 8. Public access will be maintained with minimal delays during the construction and maintenance of the Project. If there are traffic delays, NV Energy will post delay information at National Forest portals.

4.0 GENERAL CONSIDERATIONS

Vehicles traveling in the Project area will obey jurisdictional traffic speed regulations and the posted speed limit. All vehicle and equipment speeds will be limited to 20 miles per hour on unpaved roads and on the ROW/easement (design feature AQ 1). All sensitive environmental areas to be avoided will be clearly marked in the field. Public access will be maintained with minimal delays during the construction and maintenance of the Project.

NV Energy's construction contractor(s) will be responsible for ensuring that construction travel is limited to designated areas. Field personnel will be instructed to use only approved access roads, drive on Project-specific delineated roads, and obey posted speed limits.

5.0 POST-CONSTRUCTION RECLAMATION

After Project construction, NV Energy or their authorized contractor(s) will take the following measures:

- RT 3 All new access roads (i.e., spur roads and centerline travel roads) specifically constructed for this Project will be re-contoured and reclaimed and will have a physical closure installed to prevent motorized access immediately following the completion of construction and restoration. The types of closure will be approved by the USFS prior to installation. Design specifications will be provided by the USFS.
- RT 4 Physical barriers such as boulders or natural features designed to harmonize with the natural environment of the surrounding area will be installed to prevent unauthorized vehicle use from occurring on restored roads. The use of gates or other such structures for this purpose will be avoided unless determined necessary by the USFS. Design specifications will be provided by the USFS.
- RT 5 Maintenance activities which cause a road to be opened to unauthorized vehicles or damage to restoration improvements will need to be assessed and barriers reinstalled as needed at the expense of NV Energy.
- RT 6 Restored roads will require a signage and monitoring plan implemented by NV Energy for compliance with the closure which will include inspecting the barricade areas to determine the effectiveness of the blockades at preventing unauthorized motorized vehicle use of the restored access roads. Signs will notify the public that construction access roads are closed and are being restored. Signs will be replaced by NV Energy if vandalism occurs to the signs. Design specifications will be provided by the USFS.
- RT 7 If unauthorized vehicle use occurs on restored roads, barricades and reclamation will be monitored for effectiveness and remedial measures taken. Monitoring will continue until disturbed areas are successfully restored.
- RT 9 All construction vehicle movement will be restricted to the transmission line ROW/easement, pre-designated access roads, public roads, and private roads. All existing roads will be left in a condition equal to or better than their preconstruction condition, according to the appropriate maintenance level including installation of water bars, and drainage features. The expectation is to return roads to preconstruction standards. High clearance roads will be returned to a state consistent with preconstruction conditions so as to not convey a false expectation to users.
- VG 6 All areas of temporary ground disturbance that result from the construction or maintenance of the Project will be restored as required by the land management agency and per any applicable permits. Restoration will include restoring contours to their approximate preconstruction condition, stabilizing the area through seeding, mulching, placement of erosion control fabric, and installing erosion control features. Revegetation may include incorporation of chips recovered from tree slashing operations into the soil, as needed. Erosion control includes installing cross drains and placing water bars in the road, as needed.

6.0 TRANSPORTATION MANAGEMENT PRACTICES

In general, the number of construction vehicles needed for the Project is not expected to substantially increase traffic volumes. Road and lane closures are not anticipated because of the relatively short period of time that vehicles will be on the road. If road and lane closures are needed, the appropriate regulatory agencies, affected parties, and emergency service providers will be notified well in advance of the anticipated closure and the appropriate procedures identified in the U.S. Department of Transportation Manual on Uniform Traffic Control Devices (USDOT 2012 and 2016) will be followed:

- Detour routes for vehicles, pedestrians, bicycles, etc. and alternative emergency vehicle access routes will be delineated at that time;
- If practicable, road or lane closures will be scheduled for off-peak hours;
- The contractor will use caution when operating to prevent conflict with public use of the roads;
- A reflectorized “Slow Moving” vehicle emblem shall be attached to all slow-moving equipment;
- Signs with flags at either end of areas being worked along roads will be placed to warn road users of work in progress; and
- Where necessary, the contractor will use a flag person in addition to warning signs to control traffic.

Public access will be maintained with minimal delays during the construction and maintenance of the Project. If there are traffic delays, NV Energy will post delay information at National Forest portals (design feature RT 8).

7.0 REFERENCES

United States Department of Transportation (USDOT). 2012. Manual on Uniform Traffic Control Devices for Streets and Highways. 2009 Edition. Including Revision 1 and 2. May 2012.

United States Department of Transportation (USDOT). 2016. Emergency Response Guidebook: Guidebook Intended for use by First Responders during the Initial Phase of a Transportation Incident Involving Dangerous Goods/Hazardous Materials.

United States Forest Service (USFS). (1986). *Toiyabe National Forest Land and Resource Management Plan*. U.S. Department of Agriculture, Forest Service, Toiyabe National Forest.

United States Forest Service (USFS). (2010). *The Forest Service National Supplements to the FP-03*. Retrieved on May 22, 2013, from <http://www.fs.fed.us/eng/transp/documents/doc/FSSSdirections091410.doc>.

FIGURES

VA:2037\ACTIVE\203703160\03_dad\gls\gls_cad\gls_cad\gls_cad\Figures\Fig_1_Existing_Road_Access_for_Construction_v2_11x17L.mxd Revised: 2020-05-11 By: chrjohmsn

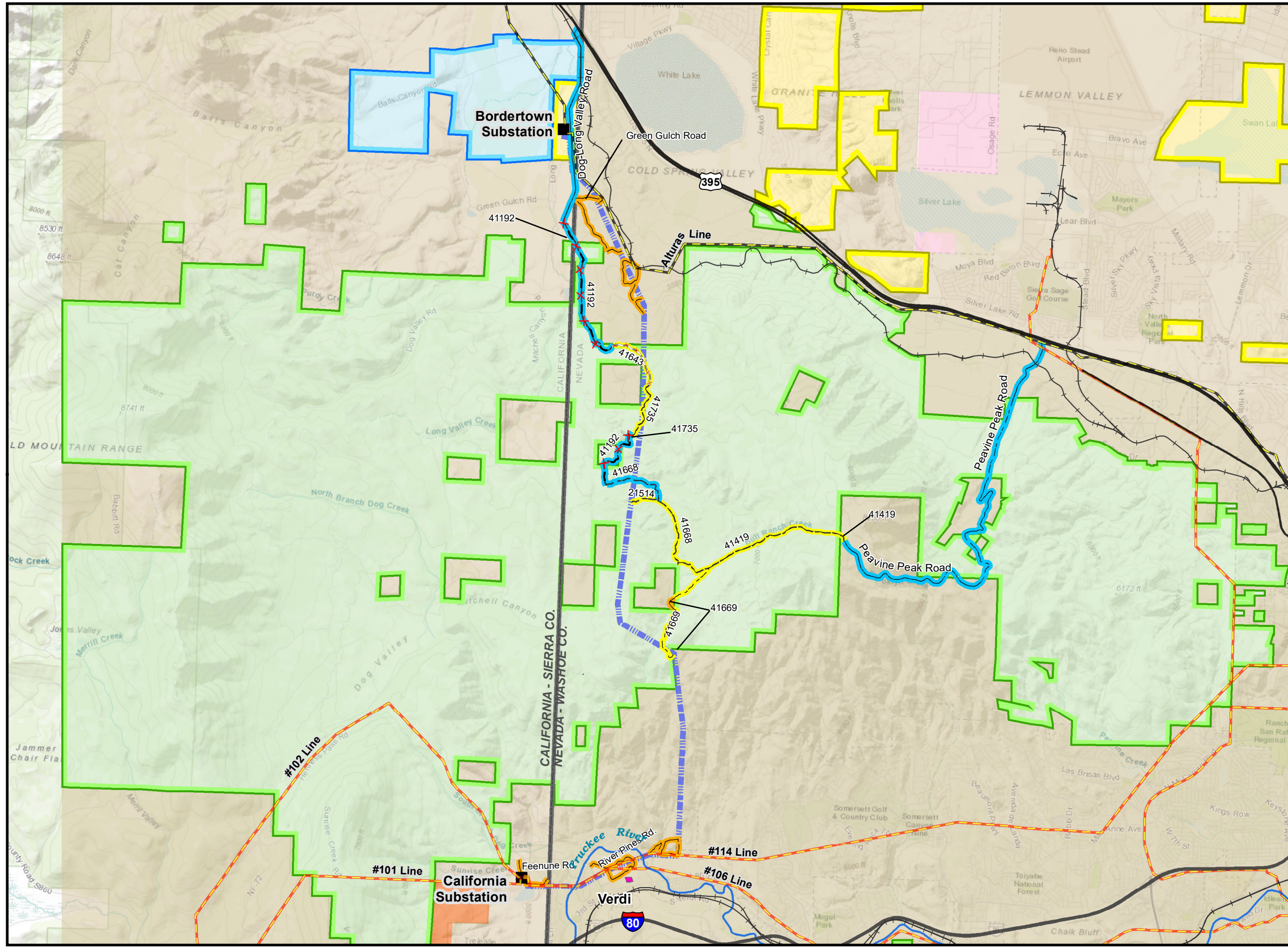

- Legend**
- Existing Substation
 - Bordertown to California 120 kV Transmission Line
 - Staging Area
 - 120 kV Transmission Line
 - 345 kV Transmission Line
- USFS Roads**
- USFS Roads
 - ✗ USFS Road (Designated Seasonal Use April 1- November 18)
 - ✗ USFS Not Open to Public Motorized Travel (Designated Seasonal Use April 1- November 18)
 - ✗ USFS Road Not Open to Public Motorized Travel
 - USFS Roads (Temporary Widening)
 - USFS Roads Used for Access (No Widening)
 - Public and Private Roads across Private Land (Temporary Widening; includes Dirt Roads)
 - Public and Private Roads Used for Access (No Widening)
- Land Ownership**
- U.S. Bureau of Land Management
 - U.S. Forest Service
 - California Department of Fish & Wildlife

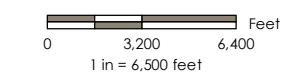

Sierra County, CA & Washoe County, NV
NAD 1983 UTM Zone 11N

PROJECT NO: 203703160
DRAWN BY: JT
1ST REVIEW: CJ
2ND REVIEW: KC
DATE: 5/11/2020

NV Energy
Bordertown to California 120 kV
Transmission Line Construction,
Operation, and Maintenance (COM) Plan

Figure 1
Existing Road Access
For Project Construction

Disclaimer: Stantec assumes no responsibility for data supplied in electronic format. The recipient accepts full responsibility for verifying the accuracy and completeness of the data. The recipient releases Stantec, its officers, employees, consultants and agents, from any and all claims arising in any way from the content or provision of the data.

Service Layer Credits: Sources: Esri, HERE, Garmin, Intermap, increment P Corp., GBBC, USGS, FAO, NRS, NRCAN, Geobase, IGN, Kadaster NL, Ordnance Survey, Esri Japan, MEI, Esri China (Hong Kong), Swisstopo, CNIG, OpenStreetMap contributors, and the GIS User Community

APPENDIX B2
Flagging and Fencing Plan

**Flagging and Fencing Plan
Bordertown to California 120 kV Transmission Line
Construction, Operation, and Maintenance (COM) Plan**

Prepared for:

NV Energy
6100 Neil Road
Reno, Nevada 89511

Prepared by:

Stantec Consulting Services Inc.
6995 Sierra Center Parkway
Reno, Nevada 89511

August 2020

Table of Contents

1.0	INTRODUCTION	1
2.0	REGULATORY REQUIREMENTS	2
3.0	METHODS	3
3.1	Project Facilities.....	3
3.2	Environmental Exclusions	3
3.2.1	Signing	3
3.2.2	Flagging	4
3.2.3	Fencing	4
3.3	Installation, Monitoring, and Maintenance of Fencing and Flagging	5
4.0	REFERENCES	6

List of Figures

- Figure 1 Typical Sign for Exclusion Area
- Figure 2 Typical Sign for No Refueling

List of Tables

Table 1	Example Signs for Marking Project Features	3
---------	--	---

LIST OF ABBREVIATIONS

EIS	Environmental Impact Statement
kV	Kilovolt
Project	Bordertown to California 120 Kilovolt Transmission Line Project
ROW	Right-of-Way
U.S.	United States
USFS	United States Forest Service



1.0 INTRODUCTION

NV Energy and its contractors will construct the Bordertown to California 120 Kilovolt (kV) Transmission Line Project (Project) in compliance with all federal, state, and local regulations as well as the National Environmental Policy Act, the Environmental Impact Statement (EIS) and Final Record of Decision, the United States (U.S.) Forest Service (USFS) Special Use Permit, and all other applicable permits. The Project area is in Washoe County, Nevada, and Sierra County, California, west and northwest of the city of Reno, Nevada. The northern boundary of the Project area is near Bordertown, Nevada, and U.S. Highway 395 and the southern boundary is near Interstate 80 between Verdi, Nevada, and Mogul, Nevada. The western boundary is roughly parallel with the California state line and the eastern boundary extends to the Peavine area generally east of Peavine Peak. The constructed 120 kV overhead transmission line will be approximately 11.9 miles long and will run between the existing Bordertown and California substations in Sierra County, California.

This Flagging and Fencing Plan is part of NV Energy's compliance obligation. This plan provides guidance to construction managers, environmental inspectors, and regulatory agencies with environmental resource protection measures that are associated with the construction of the Project. The measures to be described are intended to ensure that the contractor, NV Energy, agency personnel and other visitors to the Project area avoid sensitive resources and travel within the approved areas. In addition, the measures are an integral part of the Project's compliance program for minimizing impacts to sensitive environmental resources. This Plan also provides a description of avoidance flagging and staking that will occur before construction. It will be implemented throughout the construction period.

2.0 REGULATORY REQUIREMENTS

No federal, state or local laws, rules or regulations specifically address flagging and fencing protocols for construction projects. However, several of the Project design features from the Project EIS hinge on adequate field marking of sensitive resource areas to avoid or reduce impacts (USFS 2018). Several mitigation measures include flagging or fencing requirements to help protect vegetative cover, water quality, cultural resources, special-status species, and to minimize the spread of invasive weeds.

3.0 METHODS

3.1 PROJECT FACILITIES

Standard survey flags and stakes will be installed before the start of Project construction. Staking of facilities will include pole locations, anchor sites, staging of material yards [if known], access roads, and wire pull sites will be marked for the construction contractor. Designated Project access roads will be marked to facilitate travel to and from the right-of-way (ROW). Substation improvements will be delineated, and helicopter fly yards, wire stringing areas, and material yards will be demarcated as necessary to indicate the limits of the approved work area.

3.2 ENVIRONMENTAL EXCLUSIONS

Signs, flags and/or fencing will be used to delineate and protect sensitive environmental and cultural resources in the vicinity of construction activities. A system of standardized and simplified exclusion markings will be used to reduce potential confusion during construction, and to minimize the risk of highlighting types of sensitive resources that could be targeted by vandals (e.g., if exclusions around archaeological sites were marked differently than those around sensitive natural resource areas, the sites would be at a higher risk of unauthorized artifact collecting or other disturbance).

3.2.1 Signing

Signs will be used to help identify Project features such as approved access roads and certain Project requirements, such as the location of weed cleaning stations. Signs will be a minimum of 8.5-inches by 11-inches, printed on color paper, and will be laminated using 7-millimeter or greater laminate to withstand field conditions. Signs will be installed on metal posts, wooden stakes, or attached to exclusion fencing/roping, as appropriate. Background colors will vary to enhance sign recognitions from a distance. Table 1 provides examples of some of the signs that will be used to mark Project features. Figures 1 and 2 show the size and configuration of typical sign layouts. Signs for sensitive resource areas will be oriented for visibility from both directions of likely travel.

Table 1 Example Signs for Marking Project Features

Feature	Sign Color	Sign Text	Comments
Project access road	Bright Green	Approved Project Access (Road Number xxx)	To be located at points of intersection, additional intermittent flagging may be required.
Cultural sites, special-status wildlife and plant areas, wetlands, drainages, and invasive weed infestations adjacent to construction areas	Yellow	Sensitive Resource Area Keep Out	Signs to be installed, as needed, in addition to exclusion fencing and flagging.

Feature	Sign Color	Sign Text	Comments
Areas temporarily closed to construction due to special-status wildlife breeding, nesting, or seasonal use range.	Yellow	Sensitive Resource Area Keep Out	Signs to be installed, as needed, at logical points of entry (i.e., access road and/or centerline travel route) to excluded zone.
Invasive weed cleaning stations	Red	Weed Cleaning Station	Signs will be posted at entry points into weed cleaning stations.

3.2.2 Flagging

Survey flagging (i.e., surveyor’s ribbon tied to wooden stakes, metal posts, or vegetation) will be used to delineate the limits of work areas such as material yards, disturbance limits (i.e., boundaries of the ROW corridor), wire stringing sites, helicopter fly yards, access roads, etc., unless existing fencing or other features clearly indicate the limits of the area. Survey flagging tied to wooden stakes, metal posts, or vegetation may also be installed to temporarily mark certain resource locations as identified by Resource Specialists during their survey efforts. Survey flagging may be used to demarcate sensitive resource locations situated a safe distance from planned construction activities, but generally will not be used to define resource exclusion areas close to planned construction activities due to concerns about the visibility and stability of flagging during construction.

3.2.3 Fencing

To delineate the limits of construction activities near sensitive resources that require a high level of protection from inadvertent Project disturbance, a combination of one or more of the following fencing materials will be installed by the flagging and fencing crew:

- Rope (1/4-inch diameter in yellow or orange coloring);
- Plastic or fabric tape; and/or
- Safety fencing (plastic orange or red mesh at least 24 inches wide and at least 18 inches off the ground to facilitate travel by small animals).

Roping with periodic marking by exclusionary signs or lengths of tape is a highly visible and effective exclusion device. Roping, tape and safety fence will be installed using metal posts for increased durability. It is anticipated that the exclusion device will be installed at the margins of the sensitive resource (including any required buffers), rather than at the edge of the work area.

Construction activities may require temporary access through existing fences and gates on public and private land. Fencing will be replaced when construction activities are completed. Replacement fencing will be built to agency or landowner specifications, consistent with the fencing that was removed. During construction, fences with open gates will remain open and fences with closed gates will remain closed. Fences crossed during construction will be braced and secured prior to cutting the fence to prevent slackening of the wire.



3.3 INSTALLATION, MONITORING, AND MAINTENANCE OF FENCING AND FLAGGING

The objectives of this Flagging and Fencing Plan hinge on the proper installation, monitoring and maintenance of protective devices. NV Energy's surveying contractor(s) will be responsible for the installation and maintenance of the field marking of construction features (e.g., towers, anchors, substations, etc.). These markings will be installed in advance of construction activities in the area, maintained during construction (as necessary), and removed during clean-up activities.

Routine Project monitoring by the environmental field inspectors will include an on-going assessment of the need for replacement or repair of exclusionary flagging or fencing. Maintenance needs related to exclusionary devices will either be corrected at the time of observation by the environmental field supervisor and/or environmental field inspector or will be documented as a future need. If maintenance of an exclusionary device is needed within an active construction area, corrective action will be taken as soon as possible. Maintenance of signs, flagging and fencing within dormant areas will be implemented as necessary.

All exclusionary devices (signs, flags and fences) will be removed during Project clean-up by NV Energy's construction contractor.

4.0 REFERENCES

United States Forest Service (USFS). 2018. Final Environmental Impact Statement. Bordertown to California 120 kV Transmission Line Project. Humboldt-Toiyabe National Forest, Carson Ranger District. June 2018.

FIGURES

Figure 1 Typical Sign for Exclusion Area

**SENSITIVE
RESOURCE AREA

KEEP OUT**

Figure 2 Typical Sign for No Refueling

NO REFUELING

APPENDIX C1
Noxious Species Abatement Plan

**Noxious Weed Abatement Plan
Bordertown to California 120 kV Transmission Line
Construction, Operation, and Maintenance (COM) Plan**

Prepared for:

NV Energy
6100 Neil Road
Reno, NV 89511

Prepared by:

Stantec Consulting Services Inc.
6995 Sierra Center Parkway
Reno, NV 89511

August 2020

Table of Contents

- 1.0 INTRODUCTION..... 1**
 - 1.1 Noxious Weeds and Invasive Species Definition..... 1
 - 1.2 Goal and Objectives..... 2
- 2.0 REGULATORY REQUIREMENTS..... 3**
 - 2.1 Federal 3
 - 2.1.1 Executive Order 13112.....3
 - 2.1.2 USFS Invasive Species Management3
 - 2.1.3 BLM Manual 9015 Integrated Weed Management.....3
 - 2.2 State 4
 - 2.2.1 Nevada Noxious Weed Law4
 - 2.2.2 California Noxious Weed Law.....4
- 3.0 OVERVIEW OF EXISTING WEED CONDITIONS 6**
 - 3.1 Noxious and Invasive Weed Inventory 7
- 4.0 DESIGN FEATURES10**
 - 4.1 Pre-Construction/Construction Weed Controls10
 - 4.2 Post-Construction Weed Controls 11
 - 4.3 Herbicide Use12
 - 4.3.1 Herbicide Use Plan..... 14
- 5.0 TREATMENT METHODS.....16**
 - 5.1 Responsible Parties 18
- 6.0 SUCCESS CRITERIA, MONITORING, AND REMEDIATION19**
 - 6.1 Weed Abatement Success Criteria 19
 - 6.2 Monitoring..... 19
 - 6.3 Remediation and Adaptive Management Process.....20
- 7.0 REFERENCES.....21**

List of Tables

- Table 3-1 Ecology and Status of Noxious Weeds in the Project Area 8
- Table 4-1 Minimum Buffers (ft) for Herbicide Application Near Aquatic Features 13
- Table 5-1 Treatment Control Methods of Noxious and Invasive Species..... 16
- Table 5-2 Pesticide Use Restrictions 18

List of Figures

Figure 1 Noxious Weeds within the Project Area

List of Appendices

Appendix A Pesticide Use Proposal Form (FS 2100-02)



LIST OF ABBREVIATIONS

BLM	Bureau of Land Management
CDFA	California Department of Food and Agriculture
COM	Construction, Operations, and Maintenance
EIS	Environmental Impact Statement
EO	Executive Order
GPS	Global Positioning System
HE	Herbicide Use
kV	Kilovolt
NEPA	National Environmental Policy Act
NW	Noxious Weeds
Plan	Noxious Weed Abatement Plan
Project	Bordertown to California 120 Kilovolt Transmission Line Project
ROW	Right-of-Way
RT	Recreation/Roads/Transportation
SV	Plants and Sensitive Plant Communities
U.S.	United States
U.S.C.	United States Code
USFS	United States Forest Service



1.0 INTRODUCTION

NV Energy and its contractors will construct the Bordertown to California 120 Kilovolt (kV) Transmission Line Project (Project) in compliance with all federal, state, and local regulations as well as the National Environmental Policy Act (NEPA), the Environmental Impact Statement (EIS) and Final Record of Decision, the United States (U.S.) Forest Service (USFS) Special Use Permit, and all other applicable permits. The Project area is in Washoe County, Nevada, and Sierra County, California, west and northwest of the city of Reno, Nevada. The northern boundary of the Project area is near Bordertown, Nevada, and U.S. Highway 395 and the southern boundary is near Interstate 80 between Verdi, Nevada, and Mogul, Nevada. The western boundary is roughly parallel with the California state line and the eastern boundary extends to the Peavine area generally east of Peavine Peak. The constructed 120 kV overhead transmission line will be approximately 11.9 miles long and will run between the existing Bordertown and California substations in Sierra County, California.

This Noxious Weed Abatement Plan (Plan) is part of NV Energy's compliance obligation and is appended to the Construction, Operations, and Maintenance (COM) Plan. This Plan provides guidance to construction managers, environmental inspectors, and regulatory agencies to control the introduction and dispersal of noxious weeds and invasive species during the construction, operation, and maintenance of the Project.

1.1 NOXIOUS WEEDS AND INVASIVE SPECIES DEFINITION

For the purpose of this Plan, noxious weeds and invasive species are defined as introduced plants and animals that are mandated to be restricted or controlled because of their potential to cause economic harm (e.g., affect the quality of forage on rangelands, affect cropland or forest land productivity) or environmental harm (e.g., displace native plants and natural habitats) or harm to human and animal health. Management of these species may be legally mandated by federal, state, county, or other laws and regulations. As discussed in the EIS, this Plan addresses the potential of infestations due to temporary construction disturbance on noxious weeds and invasive species that are of concern in the Project area (USFS 2018).

The noxious weeds and invasive species discussed in this Plan are included in one or more of the following categories:

- Plant species listed as noxious weeds by the State of Nevada Department of Agriculture;
- Plant species listed as noxious weeds by the State of California Department of Food and Agriculture (CDFA);
- Noxious weeds or invasive species of concern to the USFS;
- Noxious weeds of concern to the Bureau of Land Management (BLM).



1.2 GOAL AND OBJECTIVES

The goal of this Plan for the Project is to avoid or limit increases in noxious weeds. To achieve this goal, construction, reclamation, operations, and maintenance activities should be conducted in a manner that will:

- Prevent the introduction or spread of noxious weeds into previously un-infested areas or beyond an existing infestation zone. An infestation zone is defined as an area containing a single, large infestation or several separate infestations after which none occur for several miles.
- Avoid or minimize substitutional increases in noxious and invasive weed population sizes or extents within an existing infestation zone.
- Avoid or minimize substantial increases in noxious and invasive weed population sizes or extents within an existing infestation.
- Avoid or minimize noxious weed and invasive species from moving into areas highly susceptible to invasion, but as yet not dominated by these species.
- Avoid or minimize direct or indirect adverse effects on listed or non-listed special-status plant or wildlife species or sensitive communities.
- Avoid or minimize effects on plant communities or wildlife habitat.

To achieve these goals, this Plan outlines methods to be applied during the construction and reclamation phases of the Project and provides guidance on monitoring and reporting the success of the mitigation measures.

2.0 REGULATORY REQUIREMENTS

Federal and state requirements applicable to the management of noxious weeds in the Project area include the following regulations.

2.1 FEDERAL

2.1.1 Executive Order 13112

Executive Order (EO) 13112 (February 3, 1999) addresses the prevention and introduction of invasive species and provides for their control to minimize economic, ecological, and human health impacts. Invasive species often displace native species and become dominant, in turn affecting native flora, wildlife, watersheds, fire regimes, and recreation. This EO also established the National Invasive Species Council which oversees the implementation of the order, encourages planning and action at multiple levels, develops recommendations for international cooperation, develops guidance pursuant to NEPA for prevention and control of invasive species, and facilitates development of a network of agencies to document, evaluate and monitor impacts.

2.1.2 USFS Invasive Species Management

Invasive species are regulated and/or managed through a variety of statutes administered by the states and the USFS cooperates with the states to implement those. The USFS also works cooperatively with various stakeholders to implement authorities which address invasive species as appropriate. The following orders or statutes are the primary authorities to allow the USFS to conduct invasive species management activities to meet resource management goals and objectives: the Organic Administration Act (16 United States Code [U.S.C.] 551); the Forest and Rangeland Renewable Resources Planning Act of 1974, as amended (16 U.S.C. 1604); the Federal Noxious Weed Act of 1974 (7 U.S.C. 2814); and the Cooperative Forestry Assistance Act of 1978 (16 U.S.C. 2104).

2.1.3 BLM Manual 9015 Integrated Weed Management

The BLM policy relating to the management and coordination of noxious weed activities is set forth in BLM Manual 9015 – Integrated Weed Management (BLM 1992). BLM policy requires that all ground-disturbing projects and any projects that alter plant communities be assessed to determine the risk of introducing or spreading noxious weeds. If the risk is moderate or higher, a positive management program needs to be established. Risk is assessed based on the likelihood of a species to establish as a result of the action, which is based on the presence of noxious weeds in the general area of the project (i.e., within the watershed, or other regional area) and the effect of the action on the vegetation and soil in the area. If there are noxious weeds already present in the area, and if the action will create seedbed conditions conducive to these species, then the risk is considered high. Surface-disturbing activities that expose bare mineral soil or create mesic conditions (e.g., infiltration ponds) generally result in a high risk rating.



2.2 STATE

2.2.1 Nevada Noxious Weed Law

The State of Nevada has enacted laws requiring control of noxious weeds due to the substantial economic losses caused by noxious weeds. The State of Nevada defines noxious weeds as:

“Any species of plant which is, or is likely to be, detrimental or destructive and difficult to control or eradicate.”

When Nevada law defines a weed as “noxious,” its distribution in commerce is prohibited and its control or management is mandated (Nevada Administrative Code 555). State of Nevada noxious weed definitions are as follows:

- Category A: Weeds not found or limited in distribution throughout the State; actively excluded from the State and actively eradicated wherever found; actively eradicated from nursery stock dealer premises; control required by the State in all infestations.
- Category B: Weeds established in scattered populations in some counties of the state; actively excluded where possible, actively eradicated from nursery stock dealer premises; control required by the State in areas where populations are not well established or previously unknown to occur.
- Category C: Weeds currently established and generally widespread in many counties of the State; actively eradicated from nursery stock dealer premises; abatement at the discretion of the state quarantine officer.

2.2.2 California Noxious Weed Law

Noxious weeds are defined by the state of California in Chapter 1 of the California Department of Food and Agricultural (CDFA) Code, Section 5004, as “any species of plant that is, or is liable to be, troublesome, aggressive, intrusive, detrimental, or destructive to agriculture, silviculture, or important native species, and difficult to control or eradicate, which the director, by regulation, designates to be a noxious weed.” The CDFA maintains a noxious weed list and works to prevent the introduction and spread of injurious insect or animal pests, plant diseases, and noxious weeds. Noxious weed species also receive a rating of A, B, C, D, or Q as follows (CDFA 2019):

- A-Rated: A pest of known economic or environmental detriment and is either not known to be established in California or it is present in a limited distribution that allows for the possibility of eradication or successful containment. A-rated pests are prohibited from entering the state because, by virtue of their rating, they have been placed on the of Plant Health and Pest Prevention Services Director’s list of organisms “detrimental to agriculture” in accordance with the Food and Agricultural Code Sections 5261 and 6461. The only exception is for organisms accompanied by an approved CDFA or U.S. Department of Agriculture live organism permit for contained exhibit or research purposes. If found entering or established in the state, A-rated pests are subject to state (or commissioner when acting as a state agent) enforced action involving eradication, quarantine regulation, containment, rejection, or other holding action.



- **B-Rated:** A pest of known economic or environmental detriment and, if present in California, it is of limited distribution. B-rated pests are eligible to enter the state if the receiving county has agreed to accept them. If found in the state, they are subject to state endorsed holding action and eradication only to provide for containment, as when found in a nursery. At the discretion of the individual county agricultural commissioner they are subject to eradication, containment, suppression, control, or other holding action.
- **C-Rated:** A pest of known economic or environmental detriment and, if present in California, it is usually widespread. C-rated organisms are eligible to enter the state as long as the commodities with which they are associated conform to pest cleanliness standards when found in nursery stock shipments. If found in the state, they are subject to regulations designed to retard spread or to suppress at the discretion of the individual county agricultural commissioner. There is no state enforced action other than providing for pest cleanliness.
- **D-Rated:** An organism known to be of little or no economic or environmental detriment, to have an extremely low likelihood of weediness, or is known to be a parasite or predator. There is no state enforced action.
- **Q-Rated:** An organism or disorder suspected to be of economic or environmental detriment, but whose status is uncertain because of incomplete identification or inadequate information.

3.0 OVERVIEW OF EXISTING WEED CONDITIONS

As a result of several large-scale wildland fires that have burned across the region in the past three decades, two vegetation communities are dominated by weeds and annual grasses in the Project area. The annual grasses and forbs community and the ruderal community are dominated by noxious weeds and invasive species, and both are particularly common on the dry, south-facing slopes of Peavine Peak. On Peavine Peak, the annual grasses and forbs community occurs at lower elevations, most commonly on more arid slopes and flats with a southerly aspect. The community is generally dominated by cheatgrass (*Bromus tectorum*), an invasive species, as well as other non-natives or noxious weeds, such as medusahead (*Taeniatherum caput-medusae*). The annual grasses and forbs community often occurs as a direct result of wildfire or over-grazing within eastside pine or mixed conifer-fir communities or in areas dominated by sagebrush (*Artemisia spp.*). The ruderal community is comprised of species that are first to colonize disturbed lands. Within the Project area, the ruderal community is dominated by noxious weeds and invasive species, including cheatgrass. Other noxious weeds or invasive species common to the community include Scotch (cotton) thistle (*Onopordum acanthium*), musk thistle (*Carduus nutans*), bull thistle (*Cirsium vulgare*), Russian thistle (*Salsola tragus*), tumble mustard (*Sisymbrium altissimum*), and tessellate fiddleneck (*Amsinckia tessellata*) (USFS 2018).

Within the Project area, approximately 17 species of weeds, both noxious and invasive, have been documented occurring in large stands (Figure 1). Table 3-1 summarizes the ecology of noxious weeds found within the Project area.

Of the noxious weed species identified within the area, several are of primary concern due to the degree of impact they have on ecosystem function and the density or size of the existing infestations including: musk thistle; spotted knapweed (*Centaurea stoebe ssp. micranthos*); yellow star-thistle (*Centaurea solstitialis*); bull thistle; medusahead; perennial pepperweed (tall whitetop) (*Lepidium latifolium*); Scotch thistle; and tamarisk (*Tamarix spp.*) (USFS 2018). Treatment protocols for those species are detailed in Section 5.0 (Table 5-1).

In addition, a total of four invasive species have also been identified in the Project area. Most invasive species are relatively rare within the Project area, except for cheatgrass which is mapped extensively in the Project area. Section 5.0 (Table 5-1) also provides treatment protocols for cheatgrass.

Invasive species include:

- Cheatgrass;
- Fuller's teasel (*Dipsacus fullonum*);
- Himalayan blackberry (*Rubus armeniacus*); and
- Bouncingbet (*Saponaria officinalis*).

3.1 NOXIOUS AND INVASIVE WEED INVENTORY

Prior to any Project construction activities, noxious weeds occurring on either the Nevada or California State list will be inventoried and mapped. The full extent of the population, within the required limits, will be treated prior to and following construction. Treatment methods are specified in design features in Section 4.3. This Noxious Weed Abatement Plan will be updated to include mapping of the locations of the noxious weeds once inventories are completed.

Table 3-1 Ecology and Status of Noxious Weeds in the Project Area

Common Name (<i>Scientific Name</i>)	Noxious Weed Rating		Ecological Impact	Abundance	Trend	Rate of Spread	Typical Dispersal Method	Primary Concern Species for Project (Y/N)
	California	Nevada						
Russian knapweed (<i>Acroptilon repens</i>)	Noxious B	Noxious B	Moderate	Low	Decreasing	8-11%	Seed, root buds	N
Barbed goatgrass (<i>Aegilops triuncialis</i>)	Noxious B	Invasive	High	Low	Spreading	Rapid	Seed	N
Hoary cress/Whitetop (<i>Cardaria draba</i>)	Noxious B	Noxious C	Limited	Low	Spreading	Up to 12 feet per year from one plant	Seed, root fragments	N
Musk thistle (<i>Carduus nutans</i>)	Noxious A	Noxious B	Moderate	Moderate	Managed-Spreading	Slowly expanding	Seed	Y
Diffuse knapweed (<i>Centaurea diffusa</i>)	Noxious A	Noxious B	Moderate	None to Moderate	Managed-Spreading	Very Rapid	Seed, vegetation fragments	N
Spotted knapweed (<i>Centaurea maculosa</i>)	Noxious A	Noxious A	High	None to Moderate	Managed	Rapid	Seed	Y
Yellow star-thistle (<i>Centaurea solstitialis</i>)	Noxious C	Noxious A	High	None to Low	Managed-Spreading	Exponential	Seed	Y
Canada thistle (<i>Cirsium arvense</i>)	Noxious B	Noxious C	Moderate	None to Low	Managed	Several meters per year	Seed, root fragments	N
Bull thistle (<i>Cirsium vulgare</i>)	Noxious C	Invasive	Moderate	Low	NA	Little spread except disturbed areas	Seed	Y
Poison hemlock (<i>Conium maculatum</i>)	Invasive	Noxious C	Moderate	Low	NA	Rapid spread in disturbed areas	Seed	N
Field bindweed (<i>Convolvulus arvensis</i>)	Noxious C	Invasive	NA	NA	NA	NA	Seed, root nodes	N
Medusahead (<i>Taeniatherum caputmedusae</i>)	Noxious C	Noxious B	High	Low	Spreading	<10 years	Seed	Y
Dyer's woad (<i>Isatis tinctoria</i>)	Noxious B	Noxious A	Moderate	None to Low	Managed-Eradicated	14% per year	Seed	N



Common Name (<i>Scientific Name</i>)	Noxious Weed Rating		Ecological Impact	Abundance	Trend	Rate of Spread	Typical Dispersal Method	Primary Concern Species for Project (Y/N)
	California	Nevada						
Perennial Pepperweed (tall whitetop) (<i>Lepidium latifolium</i>)	Noxious B	Noxious C	High	None to Moderate	Managed-Spreading	<10 years	Seed, spreading roots, vegetation or root fragments	Y
Scotch thistle (<i>Onopordum acanthium</i>)	Noxious A	Noxious B	High	None to Low	Managed-Spreading	<10 years	Seed	Y
Russian thistle (<i>Salsola tragus</i>)	Noxious C	Invasive	Limited	Low	No trend	Stable	Seed	N
Tamarisk (<i>Tamarix</i> sp.)	Noxious B	Noxious C	High	Low	NA	6 years, more recently 3-4% per year	Seed, vegetation and root fragments	Y
Puncture vine (<i>Tribulus terrestris</i>)	Noxious C	Noxious C	NA	NA	NA	Rapid spread in disturbed areas	Seed	N

Source: USFS 2014



4.0 DESIGN FEATURES

To reduce the potential for the introduction or spread of noxious weeds and invasive plants, design features (Noxious Weeds [NW] 1 through NW 11) would be implemented prior to, during, and following construction activities.

4.1 PRE-CONSTRUCTION/CONSTRUCTION WEED CONTROLS

To prevent the spread of noxious weeds and invasive species from Project construction activities, the following measures will be implemented:

- NW 1. Noxious weeds occurring on either the Nevada or California State list will be mapped and the full extent of the population will be treated prior to and following construction. Inventory and treatment areas will extend 100 feet from the right-of-way (ROW)/easement and all ground disturbed by Project activities. Project disturbances include roads proposed for widening, construction access roads, equipment and material staging areas, and vegetation removal, including skid trails and landings.
- NW 3. All equipment utilized off existing roads and motorized trails will be cleaned with a high-pressure power washer of all mud, dirt, and plant parts. Following cleaning, equipment will be inspected for plant parts (e.g., leaves, stems, seeds). Equipment will be cleaned and inspected again prior to re-entry if it leaves the Project site. Equipment will be inspected and cleaned again before moving from an area within the Project area with known noxious weed species. Inspections will be completed and documented by qualified personnel such as a noxious weed specialist or botanist.
- NW 4. When cut and fill is required to create access roads and structure pads, topsoil will be stockpiled and covered to prevent weeds from establishing in the soil. This topsoil will be re-spread during restoration.
- NW 5. Staging areas and fly yards will not be placed in weed infested areas. Staging areas will be inspected by qualified personnel for pre-approved use to reduce the risk of introducing noxious weeds into the project area.
- NW 6. Construction of access roads will not occur in areas heavily infested with noxious or invasive weeds.
- NW 8. All gravel and/or fill material will be certified as weed-free.
- NW 9. NV Energy will coordinate with other county, state and federal agencies to address and treat landscape level infestations of invasive plant species.
- NW 10. For invasive plants that can be effectively controlled through grubbing or manual removal, methods that prevent seed spread or re-sprouting will be used. If flowers or seeds are present, the weed will be pulled carefully to prevent seeds from falling and will be placed in an appropriate container for disposal. If flowers and seedheads are not present or are removed and disposed of as described above, the invasive plant may be pulled and placed on the ground to dry out.



NW 11. The appropriate method of control specific to the type of noxious weed will be used. Specific methods will be identified in the COM Plan.

Plants and Sensitive Plant Communities (SV) 2. Prior to construction, once access roads and pole locations are known, the following tasks will be completed for areas where surface disturbance is planned:

- a. Pre-construction surveys for jaw-leaf lupine (*Lupinus malacophyllus*), andesite popcorn flower (*Plagiobothrys glomeratus*), and moonwort ferns (*Botrychium spp.*);
- b. Mapping and flagging of sensitive plant species, wetland areas, and noxious weeds; and
- c. Noxious weed infestations will be treated according to design features NW 1 and NW 2.

The following Recreation/Roads/Transportation (RT) design features will be also implemented to discourage unauthorized off-highway vehicle use of construction access roads that could increase the risk of weed infestations. Design features RT 3 and RT 4 require that all new temporary access roads have a physical closure (i.e., barricade) installed immediately following construction. Barricades will be monitored for effectiveness and compliance with the reclamation.

RT 3. All new access roads (i.e., spur roads and centerline travel roads) specifically constructed for this project will be re-contoured and reclaimed and will have a physical closure installed to prevent motorized access immediately following the completion of construction and restoration. The types of closure and design specification used will be approved by the USFS prior to installation.

RT 4. Physical barriers such as boulders or natural features designed to harmonize with the natural environment of the surrounding area will be installed to prevent unauthorized vehicle use from occurring on restored roads. The use of gates or other such structures for this purpose will be avoided unless determined necessary by the USFS.

4.2 POST-CONSTRUCTION WEED CONTROLS

NV Energy will implement the following post-construction weed control design features:

NW 2. Monitoring and continued treatment in areas that were treated prior to construction will commence the first full growing season after project implementation. Weed treatment will continue until disturbed areas are successfully restored (restoration criteria defined below). Weed treatment will continue during maintenance activities and within the ROW.

Successfully restored areas for the Project are defined as:

Reference sites will be pre-established and approved by the USFS. Reference sites will include plant communities that are representative of the ecological site and must include plant communities that are in a late-seral and ecologically functioning condition. Appropriate reference sites will be determined by collecting baseline cover data to indicate plant succession and community structure.



NW 7. Restoration seed mixes will be certified as weed-free.

4.3 HERBICIDE USE

NV Energy and the construction contractor(s) will implement an herbicide use plan (Section 4.3.1) to help control noxious weeds as part of the Project. During herbicide application, non-target vegetation may be inadvertently exposed through direct spray, downwind drift, runoff of chemical laden soil, and accidental spills. Design features Herbicide (HE) 1 through HE 15 (detailed below) will be implemented as herbicide use features to minimize or avoid effects of herbicide use to non-target vegetation.

- HE 1. Herbicides will be used in accordance with label instructions, except where Project design features describe more restrictive measures. An herbicide use plan will be developed and included in the COM Plan (Section 4.3.1).
- HE 2. Prior to the start of application, all spray equipment will be calibrated to ensure accuracy of the delivered amounts of herbicide. Equipment used during herbicide application will be regularly inspected to insure it is in proper working order.
- HE 3. Herbicide spray applications will not occur when wind velocity is five miles per hour or greater to further minimize the potential for drift.
- HE 4. Herbicide applications will not be conducted during rain or immediately following rain when soil is saturated or runoff or standing water is present. Application will occur only under favorable weather conditions, defined as:
 - a) 30% or less chance of precipitation on the day of application based upon National Weather Service weather forecasting for the Reno area;
 - b) If rain, showers or light rains are predicted within 48 hours, the amount of rain predicted shall be no more than ¼ inch of rain; and
 - c) Rain does not appear likely at the time of application.
- HE 5. Preparation of herbicides for application, including mixing, filling of wands and rinsing of spray equipment, will take place outside of wetlands, meadows, riparian zones, wells and springs, and other sensitive sites, and more than 300 feet from surface water. Herbicide preparation will occur only on level, disturbed sites such as the interior of landings.
- HE 6. A spill cleanup kit will be readily available whenever herbicides are transported or stored. A spill kit will be carried by the applicator at all times when using the wicking application method.
- HE 7. Low nozzle pressure (<25 pounds per square inch), and a coarse spray (producing a median droplet diameter of >500 microns) will be used in order to minimize drift during herbicide applications.
- HE 8. Prior to treatments in areas of concentrated public use, the public will be notified about upcoming herbicide treatments via posting signs.



- HE 9. The herbicide spray nozzle will be kept as close to target plants as possible (within 20 inches) while achieving uniform coverage in order to limit overspray and drift to non-target vegetation.
- HE 10. Where riparian vegetation communities occur, herbicide application will be limited to directed foliar spray or wiping methods and spray will be directed away from native vegetation.
- HE 11. Herbicide treatments will not occur within 500 feet of sensitive plant occurrences.
- HE 12. Herbicide application within wet meadows will be limited to treating invasive plant infestations that occupy less than 100 square feet. Herbicide applications will be limited to wiping techniques with aminopyralid, chlorsulfuron, and glyphosate and treatment of the following high priority species: Canada thistle, yellow star-thistle, Russian knapweed or perennial pepperweed (tall whitetop) which are difficult to eradicate with non-chemical means. Meadows will be surveyed for special status plant species prior to any chemical treatments and will be monitored post-treatment to determine effects to non-targeted vegetation.
- HE 13. Herbicide application will not occur within the established buffers for aquatic features shown in Table 4-1.

Table 4-1 Minimum Buffers (ft) for Herbicide Application Near Aquatic Features

Herbicide	Application Method	Dry Aquatic Features	Streams ¹ or Ditches with Water ²	Wetland or Meadow
Aminopyralid	Spot & directed foliar spray	25	25	100
	Wiping	15	150	15
Chlorsulfuron	Directed foliar spray	25	100	100
	Wiping	15	15	15
Glyphosate	Directed foliar spray or drizzle	0	25	25
	Cut stump or wiping	0	15	15
Imazapic	Directed foliar spray	25	75	75
Triclopyr (TEA)	Directed foliar spray	25	75	75
	Wiping or cut stump	15	15	15
Clopyralid	Spot & directed foliar spray	25	50	50
	Wiping	15	15	15

¹As measured from the edge of the stream channel. If a defined channel is not present (draws do not have defined channels), measurement is from the bottom of the feature.

²As measured from the edge of the wet area or the meadow vegetation, whichever is greater. Limited conditions allowing for herbicide application within meadows are described in HE 12.

- HE 14. Herbicide application is limited to targeted treatments directed at the plant (spot treatments of the immediate area surrounding the plant are allowed with aminopyralid and clopyralid, only) using a backpack sprayer; broadcast spray methods that dispense chemical over a non-localized area will not be used.
- HE 15. Avoid application of Aminopyralid and Clopyralid sprayed mulch materials on revegetation sites.

4.3.1 Herbicide Use Plan

As required, an Herbicide Use Plan will be prepared for the Project once a complete inventory of noxious weeds is completed prior to construction and it is determined what areas and what species will be treated. The completion of a pesticide use proposal form (FS 2100-02, Appendix A) is required by the USFS and will be included in the Herbicide Treatment Plan. The form can also be found at the USFS website:

<https://www.fs.fed.us/foresthealth/protecting-forest/integrated-pest-management/pesticide-management/index.shtml>

Consultation with Native American tribes and the development of management strategies which protect the integrity of traditional cultural plant gathering locations will occur. Herbicides will not be used to treat noxious or invasive weeds in any Area of Concern or gathering site for local Tribes without consulting with the Tribes.

4.3.1.1 Herbicide Application and Handling

Before application, NV Energy or its construction contractor(s) will obtain any required permits from local authorities. Permits may contain additional terms and conditions that are outside the scope of this Plan. A licensed contractor will perform all herbicide application in accordance with applicable laws and regulations and permit stipulations.

All herbicide applications must be applied in compliance with the United States Environmental Protection Agency label instructions, except where Project design features include more restrictive measures (Section 4.3). Application of herbicides will only occur under favorable weather conditions, defined as:

- Wind velocities are five miles per hour or less;
- 30 percent or less chance of precipitation on the day of application based upon National Weather Service weather forecasting for the Reno area;
- If rain, showers or light rains are predicted within 48 hours, the amount of rain predicted shall be no more than ¼ inch of rain; and
- Rain does not appear likely at the time of application.

Preparation of herbicides for applications (i.e., mixing, filling of wands, and rinsing of spray equipment) will only occur on level, disturbed sites and will take place outside of wetlands, meadows, riparian zones, wells and springs, and other sensitive sites, and more than 300 feet from surface water.

Prior to the start of application, all spray equipment will be calibrated to ensure accuracy of the delivered amounts of herbicide. Equipment used during herbicide application will be regularly inspected to insure it is in proper working order. Herbicide application is limited to targeted treatments directed at the plant (spot treatments of the immediate area surrounding the plant are allowed with aminopyralid and clopyralid, only) using a backpack sprayer. A low nozzle pressure (<25 pounds per square inch), and a coarse spray (producing a median droplet diameter of >500 microns) will be used in order to minimize drift during herbicide applications. The spray nozzle will



be kept as close to target plants as possible (within 20 inches). NV Energy and its construction contractor will comply with herbicide application methods and requirements for sensitive plant, riparian, and wet meadow communities as described in design features HE 10, HE 11, HE 12, and HE 13.

Additionally, in areas of concentrated public use, posting signs will be placed about upcoming herbicide treatments.

4.3.1.2 Herbicide Spills and Cleanup

A spill cleanup kit will be readily available whenever herbicides are transported or stored. A spill kit will be carried by the applicator at all times when using the wicking application method. A spill cleanup kit will include:

- Personal protective equipment including clothing and gloves recommended on the product label or Safety Data Sheet;
- Absorptive clay, “kitty litter,” or another commercial adsorbent; and
- Plastic bags and bucket, shovel, fiber brush, dustpan, caution tape, highway flares (use on established roads only), and detergent.

Response to an herbicide spill will vary with the size and location of the spill, but general procedures include:

- USFS, Sierra County Environmental Health Department, and Nevada Division of Environmental Protection notification;
- Traffic control (roadside cleanup);
- Containing the spilled material;
- Cleaning up and removing the spilled herbicide and contaminated adsorptive material and soil; and
- Transporting the spilled herbicide and contaminated material to an authorized disposal site.

4.3.1.3 Worker Safety and Spill Reporting

All herbicide contractors will be state licensed to apply herbicides (and certified if restricted use herbicides are used) and obtain and have readily available copies of the appropriate Safety Data Sheets for the herbicides used. All herbicide spills will be reported in accordance with applicable laws and requirements.



5.0 TREATMENT METHODS

As stated in Section 3.0, the following species have been identified as a primary concern due to the degree of impact they have on ecosystem function and are subject to treatment and control in the Project area.

- Musk thistle;
- Spotted knapweed;
- Yellow star-thistle;
- Bull thistle;
- Medusahead;
- Perennial pepperweed (tall whitetop);
- Scotch thistle;
- Tamarisk; and
- Cheatgrass.

Table 5-1 provides the suggested treatment control methods specific to each species for the Project. Table 5-2 provides pesticide restrictions based on the state of application.

Table 5-1 Treatment Control Methods of Noxious and Invasive Species

Weed Species	Treatment Options
Musk thistle	<ul style="list-style-type: none"> • Mowing, tilling or hand removal after bolting but prior to flowering is effective; remove the top two inches of crown by digging before seed production. • Several biological control agents are available. • Apply 2,4-D, chlorsulfuron, metsulfuron or picloram to actively growing rosettes; aminopyralid or clopyralid between rosette and late-bolt stages.
Spotted knapweed	<ul style="list-style-type: none"> • Mowing plants in bud to flower stage can reduce seed production; repeated hand removal can be effective; do not burn. • Several insect biological control agents are available. • Apply 2,4-D in the rosette stage; apply clopyralid, picloram or aminopyralid between rosette and mid-bolt stages.
Yellow star-thistle	<ul style="list-style-type: none"> • Grazing, mowing, burning, pulling, digging and cultivation can be effective if done prior to seed production. • Several biological control agents are available. • Apply aminopyralid, 2,4-D, clopyralid, or picloram to actively growing plants before flowering.

Weed Species	Treatment Options
Bull thistle	<ul style="list-style-type: none"> To kill bull thistle till, hoe or hand pull it. Seeds will likely be left in the soil, so revegetate the site with desirable plants that will be able to compete with bull thistle and prevent reinvasion. These methods are most effective when done before bull thistle flowers. Mowing bull thistle will not eradicate the weed, but it can be used to limit the spread of seed if timed properly. Mow once after the plants produce a flower stalk (bolt) but before they flower, and then again about a month later. Mowing will be more effective if used in combination with other management techniques. When bull thistle plants are in the rosette growth state, clopyralid, MCPA, 2,4-D, or picloram can be used in pastures, rangeland, and non-crop areas. For plants that are in the bolting to bud stages, use metsulfuron or chlorsulfuron. It can also be sprayed during the bolt stage with great success.
Medusahead	<ul style="list-style-type: none"> Tillage, mowing or grazing prior to seed set can reduce stands. Burning has had mixed results; most effective with a hot, slow fire prior to medusahead seed maturity but after other species have dried-down; burning can also be used to reduce the thatch layer, which can increase the performance of soil-applied herbicides. Apply minopyralid, imazapic, or sulfometuron methyl before emergence or to small, actively growing plants; glyphosate to actively growing plants.
Perennial pepperweed (tall whitetop)	<ul style="list-style-type: none"> Mowing, digging, tillage, burning and grazing established stands are not effective. Apply metsulfuron or chlorsulfuron to actively growing plants through early-bloom; imazapic from full-bloom until plants become necrotic; 2,4-D and glyphosate at bud to flower can be effective if repeated for several years.
Scotch thistle	<ul style="list-style-type: none"> Hand-removal, digging or mowing prior to flowering can be effective. Apply 2,4-D, chlorsulfuron, metsulfuron or picloram to actively growing rosettes; 2,4-D + dicamba, aminopyralid, chlorsulfuron or clopyralid between rosette and late-bolt stage.
Tamarisk	<ul style="list-style-type: none"> Cutting, digging or burning must be combined with a chemical application to be effective. An insect biological control agent is available. Apply imazapyr to actively growing foliage during flowering; triclopyr, glyphosate or imazapyr as a cut stump or basal bark treatment. Success with the cut stump method using Garlon 4Ultra has also occurred.
Cheatgrass	<ul style="list-style-type: none"> The integration of chemical management tools with cultural practices is recommended for successful control. Disking and other mechanical control treatments alone are typically not recommended because disturbed soil and a fluffy seedbed usually favor cheatgrass. If mechanical control is used, multiple treatments are required to bury cheatgrass seeds at least four to six inches deep to suppress their germination. Mechanical control followed by chemical application may help to reduce the abundance of cheatgrass seeds in the seedbank. Roundup (glyphosate) can be applied at low rates in early spring to suppress competitive growth and seed production of cheatgrass. Care should be taken to only apply glyphosate when desirable vegetation is dormant to avoid risk of injury to those species. Roundup applications are limited to no more than one contiguous acre in California.

Source: NDA 2019; UNCE 2005; MSU 2008



Table 5-2 Pesticide Use Restrictions

Pesticide Name	Active Ingredient	Use Allowed by State
Weedar 64/LV4/ 2-4, D amine	2,4,-D	NV Only
Telar	Chlorsulfuron	CA or NV
Escort/Patriot	Metsulfuron	CA or NV
Tordon	Picloram	NV Only
Milestone	Aminopyralid	CA or NV
Transline	Clopyralid	NV Only
Plateau	Imazapic	NV Only
Oust	Sulfometuron methyl	CA or NV
Rodeo/Round up Pro/Aquaneat	Glyphosate	CA* or NV
Garlon 3A/4 Ultra	Tricopyr	CA or NV
Habitat/Polaris	Imazapyr	CA or NV
MCPA	2-methyl-4-chlorophenoxyacetic acid	CA* or NV

Source: CDPR 2015 and USFS 2020

5.1 RESPONSIBLE PARTIES

The construction contractor(s) will be responsible for implementing the design features as appropriate prior to and during construction, as well as during the post-construction reclamation phase. NV Energy will be responsible for implementing the design features as appropriate during the operations and maintenance phase. NV Energy and the construction contractor(s) or other subcontractor(s) will not be responsible for pre-existing weed infestations, weeds introduced by another activity (e.g., another construction project, mining, ranching, hunting, etc.), or natural occurrence (e.g., fire); weeds found beyond the ROW; or weeds along existing access roads that are not improved by the Project.

6.0 SUCCESS CRITERIA, MONITORING, AND REMEDIATION

6.1 WEED ABATEMENT SUCCESS CRITERIA

Weed management will be considered successful if noxious weed infestations in areas disturbed by construction are no greater in density and extent than prior to construction, five years following the completion of construction.

NV Energy will not be responsible for new or recurring infestations caused by the spread of weeds from surrounding and adjacent lands, unless it can be demonstrably shown to be the result of disturbance caused by NV Energy.

6.2 MONITORING

Weed abatement monitoring will consist of both qualitative and quantitative analyses. Mapping and flagging will be conducted prior to construction for noxious weeds. Post-construction monitoring will continue annually until success criteria are met. Objectives of monitoring include the following:

- Qualitatively assess and describe the status of weed abatement Project disturbance areas;
- Identify and remedy areas exhibiting weed abatement failure;
- Document and map areas where weed abatement is not progressing;
- Assess if any problems are occurring and determine whether remedial measures are necessary.

Weed abatement monitoring will be conducted during the growing season for most weeds, between late May and mid-July. Monitoring will be conducted by vehicle and/or on foot in the disturbed areas along ROW/easement, the roads proposed for widening, construction access roads, equipment and material staging areas, and vegetation removal areas. Species names and locations of weed infestations will be recorded on field datasheets and Global Positioning System (GPS) coordinates will be recorded using a GPS with sub-meter accuracy. Photographs will also be taken of each targeted population prior to treatment and one year following treatments. Infestation size and density estimates for representative samples will be included on the maps and/or on the field datasheets at the levels listed below.

- Satellite Populations (i.e., possible new colonies): Defined as a very small infestation areas (less than 25 square-feet) that have only a few individual plants and are found apart from dense or large weed populations.
- Infestation Sites: Defined as a site in which a minimum of 25 square-feet is populated by a weed species. Densities of these weed populations will be estimated as high (i.e., greater than 50 plants), medium (i.e., 10 to 50 plants), or low (i.e., less than 10 plants), based on the average number of plants per square-foot. Densities can be defined



differently for different weed species, as appropriate. All density definitions should be provided on the field monitoring sheets.

The data will be qualitatively compared with preconstruction monitoring data for the same infestation areas and/or reference sites adjacent to the original infestation areas.

6.3 REMEDIATION AND ADAPTIVE MANAGEMENT PROCESS

If monitoring indicates that sites disturbed by Project activities have not met or are not trending toward meeting success criteria, the weed abatement methods may need to be adjusted. Herbicide applications will be determined in consultation with the appropriate agencies. Remedial measures will be implemented as soon as practicable in problem areas, selected on a case-by-case basis, and subject to agency and landowner approval.

In some cases, NV Energy will not be able to control the spread of noxious weeds in the Project area independently. Weed distributions in the Project area are also influenced by activities of property owners, authorized users (e.g., recreational users), and managing agencies of public lands like the USFS and BLM. To be truly successful, these property owners and managing agencies would also need to initiate weed abatement controls in the local area and surrounding region. Furthermore, weed abatement can be very difficult in arid areas, especially during drought years.

If noxious weed abatement criteria are not met within five years following the end of construction and reclamation, NV Energy may negotiate with the USFS or appropriate agencies to fund further efforts to comply with the mitigation requirements.

7.0 REFERENCES

- Bureau of Land Management (BLM). 1992. BLM Manual 9015-Integrated Weed Management. December 1992.
- California Department of Food and Agriculture (CDFA). 2019. Plant Health and Pest Prevention Services. Encycloweed: Weed Ratings. Accessed April 2019 online at: http://www.cdfa.ca.gov/plant/IPC/encycloweed/winfo_weedratings.html.
- California Department of Pesticide Regulation (CDPR). 2015. California Restricted Materials Requirements. Accessed June 30, 2020 at: <https://www.cdpr.ca.gov/docs/enforce/dpr-enf-013a.pdf>
- Montana State University Extension (MSU). 2008. Cheatgrass: Identification, Biology, and Integrated Management. Accessed August 2019 online at: <http://ipm.montana.edu/documents/Cheatgrass.pdf>.
- Nevada Department of Agriculture (NDA). 2019. Nevada Noxious Weed List. Accessed online August 2019 at: http://agri.nv.gov/Plant/Noxious_Weeds/Noxious_Weed_List/.
- United States Forest Service (USFS). 2014. Specialist Report: Vegetation Resources. Bordertown to California 120 kV Transmission Line Project. Sierra County, California and Washoe County, Nevada. Humboldt-Toiyabe National Forest. Carson Ranger District. September 2014.
- United States Forest Service (USFS). 2018. Final Environmental Impact Statement. Bordertown to California 120 kV Transmission Line Project. Humboldt-Toiyabe National Forest, Carson Ranger District Sierra County, California, and Washoe County, Nevada. June 2018.
- United States Forest Service (USFS). 2019. Invasive Species Program: Policy and Authorities. <https://www.fs.fed.us/invasivespecies/policy.shtml>.
- United States Forest Service (USFS). 2020. Approved Herbicides. Memo from Courtney Ghiglieri received via email June 29, 2020.
- University of Nevada Cooperative Extension (UNCE). 2005. Identification and Management of Bull Thistle. Accessed August 2019 online at: <https://www.unce.unr.edu/publications/files/nr/2005/FS0503.pdf>.

FIGURES

V:\2037\ACTIVE\20370316\03_03_data\gls\mxd\Appendix_Figures\Fig_1_Noxious_weed_abatement_Plan_v2_11x17P.mxd Revised: 2020-05-11 By: chiphinson

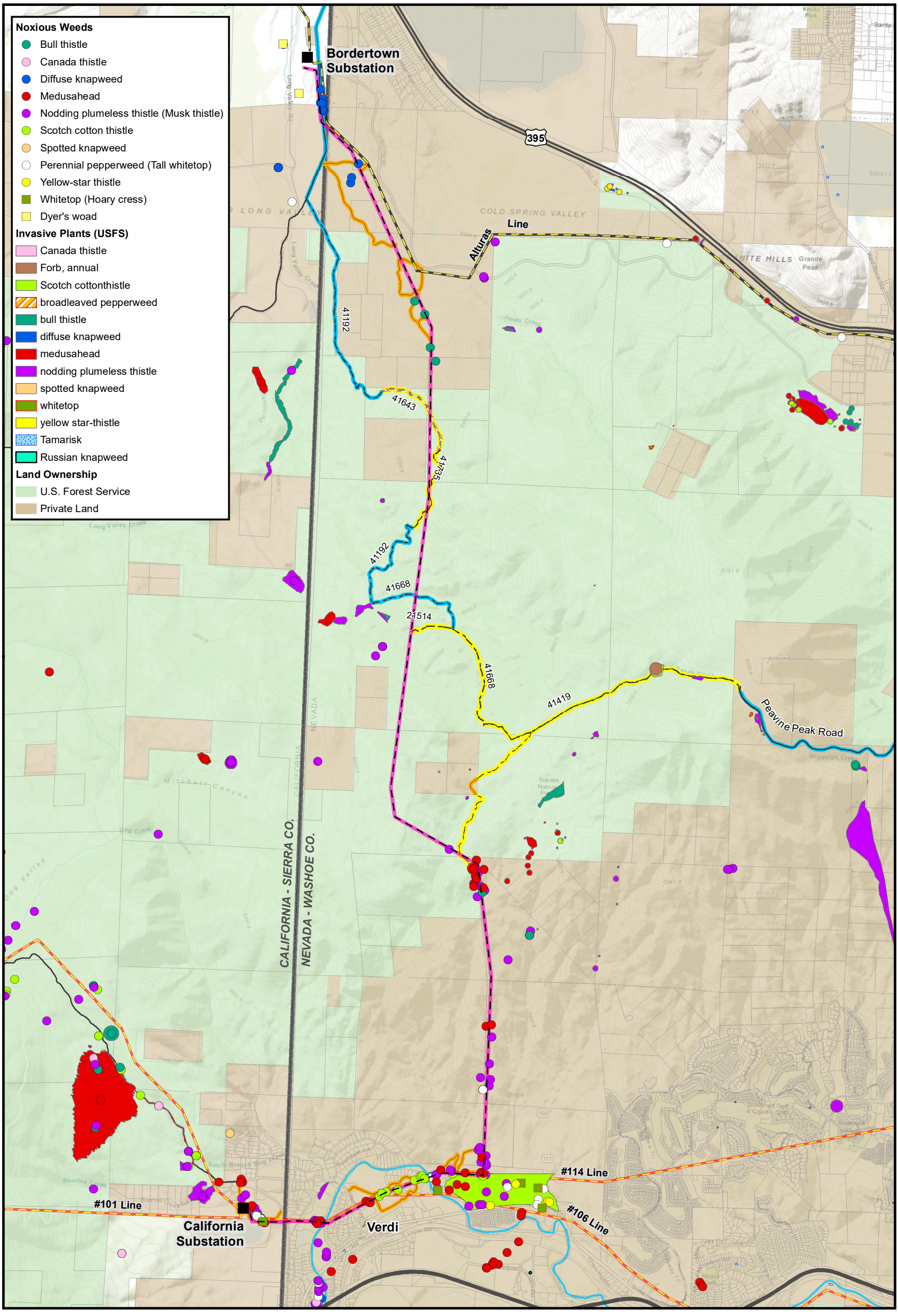

- Noxious Weeds**
- Bull thistle
 - Canada thistle
 - Diffuse knapweed
 - Medusahead
 - Nodding plumeless thistle (Musk thistle)
 - Scotch cotton thistle
 - Spotted knapweed
 - Perennial pepperweed (Tall whitetop)
 - Yellow-star thistle
 - Whitetop (Hoary cress)
 - Dyer's woad
- Invasive Plants (USFS)**
- Canada thistle
 - Forb, annual
 - Scotch cottonthistle
 - broadleaved pepperweed
 - bull thistle
 - diffuse knapweed
 - medusahead
 - nodding plumeless thistle
 - spotted knapweed
 - whitetop
 - yellow star-thistle
 - Tamarisk
 - Russian knapweed
- Land Ownership**
- U.S. Forest Service
 - Private Land

- Substation
- Bordertown to California 120 kV Transmission Line
- 90-ft ROW
- USFS Roads**
- USFS Roads
- ××× USFS Road Not Open to Public Motorized Travel
- Private and Roads**
- Public and Private Road
- USFS Roads (Temporary Widening)
- USFS Roads Used for Access (No Widening)
- Public and Private Roads across Private Land (Temporary Widening; includes Dirt Roads)
- Public and Private Roads Used for Access (No Widening)
- 120 kV Transmission Line
- 345 kV Transmission Line

1 in = 4,000 feet

T19N, R18E Washoe County, NV
 NAD 1983 UTM Zone 11N

DRAWN BY: CJ	1ST REVIEW: JT	2ND REVIEW: MB
DATE: 5/11/2020	PROJECT NO: 203703160	

NV ENERGY
 BORDERTOWN TO CALIFORNIA 120 KV
 TRANSMISSION LINE CONSTRUCTION,
 OPERATION, AND MAINTENANCE
 (COM) PLAN

**Figure C1-1
 Noxious Weed
 Abatement Plan**

Disclaimer: Stantec assumes no responsibility for data supplied in electronic format. The recipient accepts full responsibility for verifying the accuracy and completeness of the data. The recipient releases Stantec, its officers, employees, consultants and agents, from any and all claims arising in any way from the content or provision of the data.

Service Layer Credits: Sources: Esri, HERE, Garmin, Intermap, increment P Corp., GEBCO, USGS, FAO, NIS, MRCAN, Geobase, IGN, Kadaster NL, Ordnance Survey, Esri Japan, METI, Esri China (Hong Kong), Swisstopo, Swisstopo, Swisstopo, and the GIS User Community

APPENDIX A

Pesticide Use Proposal Form



Pesticide-Use Proposal

(Reference FSM 2150)

FS-2100-0002 (REV.02/2019)
OMB 0596-0241 Exp. 2/28/2022

To complete this form, see instructions for Form FS-2100-0002, Pesticide-Use Proposal

Agency / Cooperator*	Contact Name, Phone Number and e-mail*

Region*	Forest/District*	Date Submitted*

How would you like to be informed of the decision on your proposal?*

Telephone E-mail Both

<p>1) OBJECTIVE a) Project name and/or identifier b) Specific target pests(s) c) Purpose</p>	
<p>2) PESTICIDE PRODUCT(S) a) Trade name b) Formulation as purchased c) Restricted-use Pesticide(yes/no) d) EPA registration number e) Common name of chemical(s) f) AI, AE, IU, or PIB expressed as % or concentration</p>	
<p>3) TYPE OF APPLICATION a) Method b) Equipment</p>	
<p>4) FIELD APPLICATION INFORMATION a) Formulation of material to be applied b) Planned application rate c) Dilution rate d) Diluent e) Pounds of AI or AE per acre(or other applicable rate) f) Other pesticides being applied to proposed treatment site(s)</p>	
<p>5) TREATMENT AREA DESCRIPTION a) Targeted treatment area b) State and County c) Site Description d) Estimate of acres(or other unit) to be treated e) Number of applications f) Month(s) and year(s) of application</p>	
<p>6) SENSITIVE AREAS a) Special designated area (if applicable) b) Areas to be avoided c) Areas to be treated with caution</p>	

7) PROJECT IMPLEMENTATION

- a) Trained/certified personnel to be used
- b) Personal safety
- c) State and local coordination
- d) Best management practices
- e) Monitoring
- f) Additional project information

For Official Use Only

8. REVIEWER SIGNATURE(S)

a) Pesticide Use Coordinator	_____	Date	_____
b) Other reviewer(s) (as necessary)	_____	Date	_____
Other reviewer(s) (as necessary)	_____	Date	_____
Other reviewer(s) (as necessary)	_____	Date	_____
c) Approval (signature of approving official)	_____	Date	_____

Attach File(s)

Submit by Email

Burden Statement

According to the Paperwork Reduction Act of 1995, an agency may not conduct or sponsor, and a person is not required to respond to a collection of information unless it displays a valid OMB control number. The Valid OMB control number for this information collection is 0596-0241. The time required to complete this information collection is estimated to average 2 hours per response including the time for reviewing instructions, searching existing data sources, gathering and maintaining the data needed, and completing and reviewing the collection of information.

The U.S. Department of Agriculture (USDA) prohibits discrimination in all its programs and activities on the basis of race, color, national origin, gender, religion, age, disability, political beliefs, sexual orientation, and marital or family status. (not all prohibited bases apply to all programs) Persons with disabilities who require alternative means for communication of program information (Braille, large print, audiotape, etc) should contact USDA's TARGET Center at (202) 720-2600 (Voice and TDD).

To file a complaint of discrimination, write USDA, Director, Office of Civil Rights, 1400 Independence Avenue, SW, Washington, DC 20250-9410 or call (800) 795-3272 (voice) or (202) 720-6382 (TDD). USDA is an equal opportunity provider and employer.

APPENDIX C2

Streams, Wetlands, Wells, and Springs Protection Plan

**Wells, Springs, Streams, Riparian Zones, and Wetlands
Protection Plan
Bordertown to California 120 kV Transmission Line
Construction, Operation, and Maintenance (COM) Plan**

Prepared for:

NV Energy
6100 Neil Road
Reno, NV 89511

Prepared by:

Stantec Consulting Services Inc.
6995 Sierra Center Parkway
Reno, NV 89511

August 2020

Table of Contents

1.0	INTRODUCTION	1
2.0	REGULATORY OVERVIEW	2
2.1	Federal	2
2.2	State	2
3.0	OVERVIEW OF WELLS, STREAMS, RIPARIAN ZONES, AND WETLANDS	3
3.1	Wells and Springs.....	3
3.2	Streams	3
3.3	Riparian Zones and Wetlands	4
4.0	DESIGN FEATURES	6
4.1	General Aquatic Resources Protection Measures	6
4.2	Temporary Stream Crossings	6
4.3	Spill Prevention	7
4.4	Erosion and Sedimentation	7
5.0	MONITORING	9
6.0	REFERENCES	10

List of Figures

Figure 1 Waterbody Crossings

List of Tables

Table 3-1	Wells and Springs.....	3
Table 3-2	Number of Streams within the Project Area.....	3
Table 3-3	Preliminary Jurisdictional Determination	4
Table 3-4	Acres of Wetlands within the Project Area	5

LIST OF ABBREVIATIONS

AFA	Acre-feet Annually
BMP	Best Management Practice
cfs	Cubic Feet per Second
GP	General Practices
HM	Hazardous Materials and Waste
kV	Kilovolt
NDEP	Nevada Division of Environmental Protection
NPDES	National Pollutant Discharge Elimination System
Plan	Wells, Springs, Streams, Riparian Zones, and Wetlands Protection Plan
Project	Bordertown to California 120 Kilovolt (kV) Transmission Line Project
ROW	Right-of-Way
SPCC	Spill Prevention, Control, and Countermeasure Plan
U.S.	United States



USACE	U.S. Army Corps of Engineers
USFS	U.S. Forest Service
WA	Water Resources and Soil
WL	Wildlife and Sensitive Wildlife Species



1.0 INTRODUCTION

NV Energy and its contractors will construct the Bordertown to California 120 Kilovolt (kV) Transmission Line Project (Project) in compliance with all federal, state, and local regulations as well as the National Environmental Policy Act, the Environmental Impact Statement and Final Record of Decision, the United States (U.S.) Forest Service (USFS) Special Use Permit, and all other applicable permits. The Project area is in Washoe County, Nevada, and Sierra County, California, west and northwest of the city of Reno, Nevada. The northern boundary of the Project area is near Bordertown, Nevada, and U.S. Highway 395 and the southern boundary is near Interstate 80 between Verdi, Nevada, and Mogul, Nevada. The western boundary is roughly parallel with the California state line and the eastern boundary extends to the Peavine area generally east of Peavine Peak. The constructed 120 kV overhead transmission line will be approximately 11.9 miles long and will run between the existing Bordertown and California substations in Sierra County, California.

This Wells, Springs, Streams, Riparian Zones, and Wetlands Protection Plan (Plan) is part of NV Energy's compliance obligation and is appended to the Construction, Operations, and Maintenance (COM) Plan. This Plan provides guidelines for the crossings of watercourses in the Project area and for the protection of wetland and riparian resources. This Plan describes measures to protect streams and wetlands from impacts associated with Project construction. This includes measures to be implemented when crossing or working adjacent to these areas including erosion or sedimentation control measures specific to streams and wetlands.

2.0 REGULATORY OVERVIEW

The construction, operation, and maintenance phases of the Project are subject to various regulations designed to protect environmental resources and the public. Regulations that are relevant to water resources are outlined below.

2.1 FEDERAL

General water quality is protected under the federal Clean Water Act and a permit is required if a project will result in the alteration of or discharges into watercourses, water bodies (waters of the U.S.), or wetlands. The U.S. Army Corps of Engineers (USACE) and Environmental Protection Agency regulate the placement of fill into waters of the U.S. under Section 404 of the Clean Water Act.

2.2 STATE

In Nevada, waters of the State are defined by the State of Nevada in Nevada Revised Statutes 445A.415 and include all surface waters and wetlands, regardless of their federal status. The Nevada Division of Environmental Protection (NDEP) is responsible for administration of the Nevada Water Pollution Control Law, which provides state authority to protect water quality. The NDEP also regulates Section 401 Water Quality Certification, Stormwater Permits for Construction Activity, and Temporary Permits for Working in Waterways for the Project.

3.0 OVERVIEW OF WELLS, STREAMS, RIPARIAN ZONES, AND WETLANDS

3.1 WELLS AND SPRINGS

There is one identified permitted underground water well and one identified permitted spring located within the ROW/easement (NDWR 2019). Details of the well and spring are included in **Table 3-1** and the locations included on **Figure 1**.

Table 3-1 Permitted Wells and Springs within the ROW/Easement

Permit Number	Application Status	Owner of Record	Source	Use	Point of Diversion	Diversion Rate (cfs)	Duty (AFA)
47611	Certificate	Washoe County	Underground	Quasi municipal	T19N, R18E, Section 7	0.017	3.36
V11207	Vested Right	Heinz Holdco, LLC	Spring	Irrigation	T20N, R18E, Section 5	Entire flow source is diverted.	0

cfs = cubic feet per second
 AFA = acre-feet annually
 Source: NDWR 2019

3.2 STREAMS

The Project spans two major watersheds: the Honey-Eagle Lakes watershed and the Truckee watershed, which includes the Truckee River (**Figure 1**).

Streams within the southern portion of the Project area are within the Truckee watershed and includes the Truckee River. Streams in the northern portion of the Project area are within the Honey-Eagle Lakes watershed, and drain to Long Valley Creek, White Lake, or Silver Lake. The total number of perennial, intermittent, and ephemeral streams identified in the Project area, including those on USFS land, are detailed in **Table 3-2** below.

Table 3-2 Number of Streams within the Project Area

Stream Flow Regime	Located on USFS Land	Total
Perennial	0	3
Intermittent	0	0
Ephemeral	9	15
Total	9	18

Source: USFS, 2018

Streams and wetlands within the Project area were evaluated to determine whether the stream would be considered a water of the U.S., subject to regulation under the Clean Water Act. The results of this evaluation are presented in **Table 3-3**.

Table 3-3 Preliminary Jurisdictional Determination

Stream Name	Stream #	Sub-Watershed	Land Status	Waters of the U.S. Determination Rationale
Bull Ranch Creek	34	Bull Ranch Creek	Private	Yes; Relatively permanent tributary of the Truckee River.
Truckee River	35, 36	Bull Ranch Creek	Private	Yes; Traditional Navigable Water.
Unnamed Stream	37	Bull Ranch Creek	USFS	Yes; Hydrological and ecological significant nexus to the Truckee River.
Bull Ranch Creek	38	Bull Ranch Creek	USFS	Yes; Hydrological and ecological significant nexus to the Truckee River.
Unnamed Stream	39	Bull Ranch Creek	Private	Yes; Hydrological and ecological significant nexus to the Truckee River.
Unnamed Stream	40	Bull Ranch Creek	Private	Yes; Relatively permanent tributary of the Truckee River.
Unnamed Stream	3-6	Long Valley Creek	USFS	Yes; Interstate Water.
Unnamed Stream	10, 11	Long Valley Creek	USFS	Yes; Interstate Water.
Unnamed Stream	1,2	Cold Spring Valley	Private	No; Isolated with No Interstate Commerce Use.

Source: USFS 2014

No formal coordination with the USACE was conducted for the preliminary jurisdictional determination presented in **Table 3-3**, and therefore, the determination of jurisdictional status should only be considered preliminary until verified by the USACE. Regardless of their federal status, all surface waters and wetlands within the Project area would be considered waters of the State of Nevada.

However, the permanent Project facilities are expected to span all potentially jurisdictional drainages along the route and no transmission line structures would impact jurisdictional waters (including wetlands). Whenever possible, temporary access would occur from both sides of drainages and construction contractors would avoid crossing drainages and potential impacts. If a drainage must be crossed for temporary access, the required permits will be obtained and the design features described in Section 4.0 will be implemented.

3.3 RIPARIAN ZONES AND WETLANDS

Intermittent and perennial streams identified in **Table 3-2** support wetland riparian zones. The wetland riparian zones of the largest streams are dominated by willow shrubs, while riparian zones of smaller streams are dominated by wetland grasses and forbs (i.e., wet meadow). A few isolated springs and seeps are present outside of stream zones and are generally dominated by grasses and forbs. **Table 3-4** details the acreage of wetlands, which includes the wetland riparian zones and off-channel wetlands that are found within the variable-width corridor and road widening corridor for the Project, Including on USFS land.



Table 3-4 Acres of Wetlands within the Project Area

Analysis Area	Located on USFS Land	Total
Variable Width-Corridor	1.1	21.8
Road Widening Corridor	1.1	1.3
Total	2.2	23.1

Source: USFS 2018

Riparian zones and wetlands that could be impacted from the Project occur along streams. The permanent transmission line facilities of the Project will span riparian zones and wetlands along streams. Ancillary facilities such as staging areas and log landings will be placed outside of streams.

Additionally, construction activities, including temporary road crossings, would not require the placement of permanent, above-ground fill within designated special flood hazard areas. No impacts to floodplains would occur as a result of construction of the Project.

4.0 DESIGN FEATURES

NV Energy and the construction contractor(s) will implement the design features discussed in this section to minimize Project impacts to streams, riparian zones, and wetlands where they occur along the Project route.

4.1 GENERAL AQUATIC RESOURCES PROTECTION MEASURES

General Practices (GP) 1. All environmentally sensitive areas (i.e., culturally sensitive areas, meadows, and special status plant populations) will be temporarily fenced during construction for avoidance.

Plants and Sensitive Plant Communities (SV) 3. There will be no new access roads or widening of existing roads for construction access through meadows. This measure will also protect potential habitat for special status plant populations that are found in wetland and meadow habitats, such as Dog Valley ivesia.

Water Resources and Soil (WA) 3. Construction equipment staging areas, and storage of equipment fuels will not be located within 300 feet of perennial streams or within 150 feet of intermittent and ephemeral streams. Staging areas and fuel storage will also not be located within 150 feet of wetlands or other water features.

WA 4. Pole sites and staging areas will not be constructed within the 100-year floodplain of any stream or within wetlands.

WA 7. Water drafting (i.e., water withdrawal) from streams will not be permitted. Water shall be provided by truck for dust abatement and other project needs.

Wildlife and Sensitive Wildlife Species (WL) 10. To limit the potential for impacts to aquatic resources, particularly to Lahontan cutthroat trout, pole sites or roads will not be placed within the 100-year floodplain in Dog Creek, Bull Ranch Creek, and the Truckee River. During construction, no soil disturbing activities will occur within the 100-year floodplain of these streams.

4.2 TEMPORARY STREAM CROSSINGS

WA 8. Improvements to any existing road crossing will be designed to minimize surface disturbance.

WA 9. Crossings will be located where the stream channel is narrow, straight, and uniform, and has stable soils and relatively flat terrain. Stream crossings will be oriented perpendicular to the stream channel. All stream crossings will be designed and installed such that sufficient load-bearing strength for the expected equipment is provided.

WA 10. Stream crossings will be designed for a normal range of flows for the site, and crossings that must remain in place during high runoff seasons will be stabilized. However, all new crossings will be temporary and will be removed at the end of the construction season. The water body profile and substrate will be restored when the crossing is removed.



Improvements to existing crossings will be removed or stabilize and retained as part of the Reclamation and Habitat Restoration Plan.

- WA 11. Stream crossings will be regularly monitored to evaluate the condition. Any repairs or improvements to the crossings identified during monitoring will be promptly addressed.
- WA 12. Surface drainage and roadway stabilization measures will be used to disconnect the access road from the stream in order to avoid or minimize water and sediment from being channeled into surface waters and to dissipate concentrated flows.
- WA 13. On perennial streams, existing crossings will be utilized whenever possible and any temporary new crossings will be constructed in accordance with permit requirements.
- WA 14. If it is determined that a stream crossing is needed, and a Section 404 permit is needed an application for a permit will be completed at that time.
- WA 15. Perennial streams may have environmental resource designs which may include ramp crossings outside of ordinary high-water mark.

4.3 SPILL PREVENTION

Hazardous Materials and Waste (HM) 1. A Spill Prevention, Control, and Countermeasure Plan (SPCC) will be implemented during construction to prevent any spills. The SPCC, which will include cleanup procedures, will become part of the COM plan.

4.4 EROSION AND SEDIMENTATION

- WA 1. As a part of the COM Plan, a Stormwater Pollution Prevention Plan (SWPPP) will be prepared to minimize erosion from the Project construction worksites and to contain sediment. The SWPPP will be prepared in accordance with the National Pollutant Discharge Elimination System (NPDES) General Construction Stormwater Permit. At a minimum, it will identify the existing drainage patterns of the construction work sites and ROW/easement, nearby drainages and washes, potential pollutant sources other than sediment, and erosion and sediment control measures and Best Management Practices (BMPs) that will be implemented to protect stormwater runoff. The SWPPP will include maps with locations for erosion and sediment control measures, and BMPs. The SWPPP will be kept on site throughout the duration of construction.
- WA 2. Erosion and stormwater controls will be inspected on the ground at least once every seven days and within 24 hours of a storm event of 0.5 inch or greater. Weather forecasts and data available from the National Weather Service in Reno will be used to determine total precipitation associated with a storm event. Qualified personnel of NV Energy or its contractors with specific training in erosion and sediment control will perform the inspections.
- WA 5. Construction equipment will not be operated on unstable soils or on soils too wet to adequately support equipment in order to prevent rutting, puddles on soil surface, or runoff of sediments directly into waterbodies.

- VG 5. Where removal of vegetation other than trees is unavoidable, the vegetation will be cut at ground level to preserve the root structure and allow for potential sprouting.
- VG 6. All areas of temporary ground disturbance that result from the construction or maintenance of the Project will be restored as required by the land management agency and per any applicable permits. Restoration will include restoring contours to their approximate pre-construction condition, stabilizing the area through seeding, mulching, placement of erosion control fabric, and installing erosion control features. Revegetation may include incorporation of chips into the soil, as needed. Erosion control includes installing cross drains and placing water bars in the road, as needed.

5.0 MONITORING

Stream crossings will be regularly monitored to evaluate the condition during and following the Project's construction period. The principle criterion for measuring the success of protection measures for stream and wetland crossings is to ensure that sediment transport levels are not increased above pre-construction levels. Monitoring of streams and wetland protection measures during the construction and post-construction phases of the Project will be in accordance with the Reclamation and Habitat Restoration Plan (Appendix C3 of the COM Plan).

6.0 REFERENCES

- State of Nevada Division of Water Resources (NDWR). (2019). Nevada Water Rights Mapping Application. Accessed August 2019 online at:
http://webgis.water.nv.gov/Html5Viewer/Index.html?configBase=http://webgis.water.nv.gov/Geocortex/Essentials/REST/sites/NDWR_Water_Rights/viewers/NDWR_Water_Rights1/virtualdirectory/Resources/Config/Default.
- United States Forest Service (USFS). (2014). Specialist Report: Water and Soils Bordertown to California 120 kV Transmission Line Project. Carson City, Nevada: U.S. Department of Agriculture, Forest Service, Humboldt-Toiyabe National Forest, Carson Ranger District.
- United States Forest Service (USFS). (2018). Final Environmental Impact Statement. Bordertown to California 120 kV Transmission Line Project. Humboldt-Toiyabe National Forest, Carson Ranger District Sierra County, California, and Washoe County, Nevada. June 2018.

FIGURE

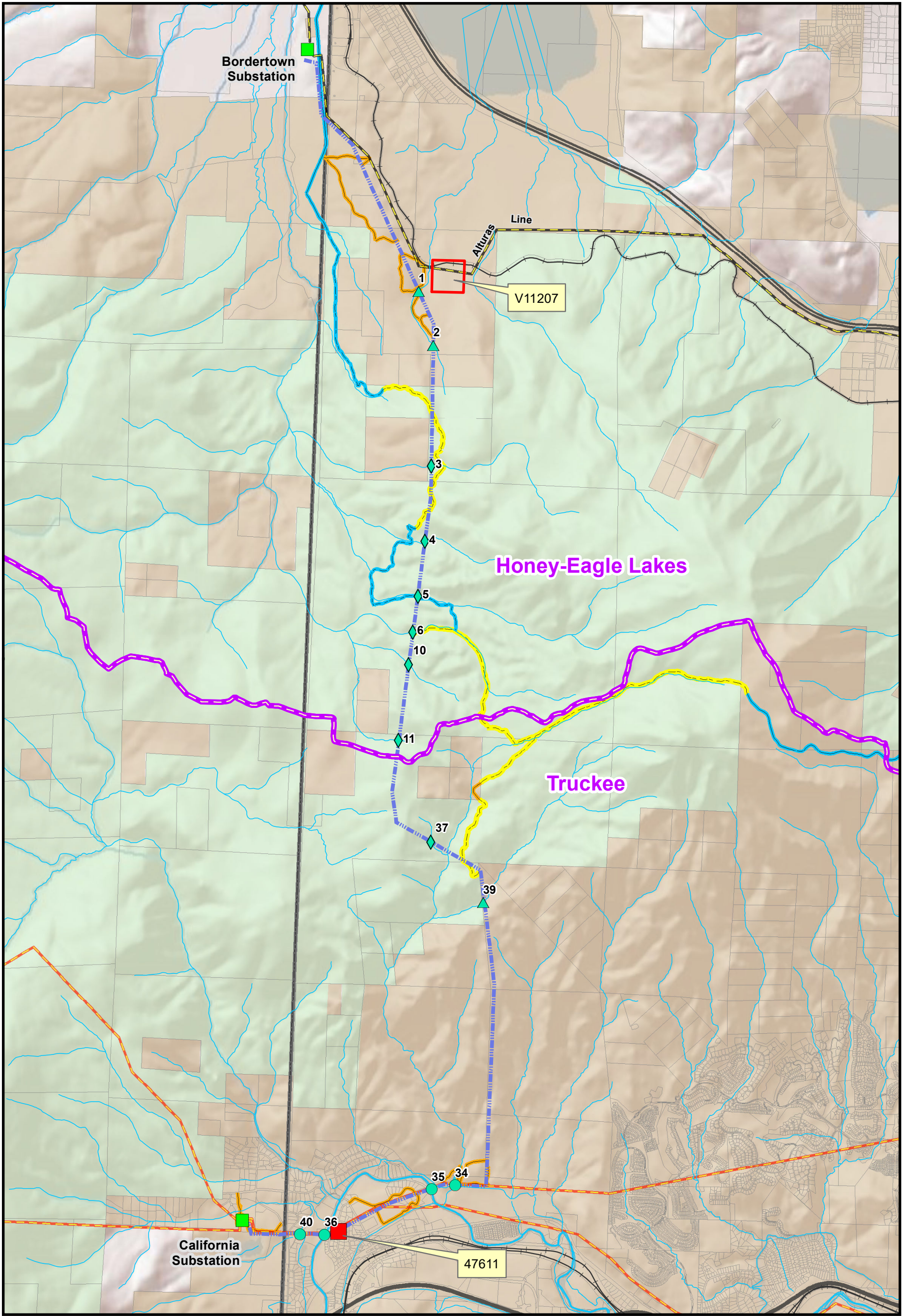

V:\2037\Active\203703160\03_datal\gis\ccad\gis\mxd\Appendix\Figures\Fig_1_Waterbody_Crossings_11x17P.mxd Revised: 2020-05-12 By: chjohnson

Water Crossings

- ◆ Ephemeral Channel
- ▲ Intermittent
- Perennial
- V11207
- USGS Hydrologic Unit
- Substation
- Bordertown to California 120 kV Transmission Line
- 120 kV Transmission Line

- 345 kV Transmission Line
 - USFS Roads (Temporary Widening)
 - USFS Roads Used for Access (No Widening)
 - Public and Private Roads across Private Land (Temporary Widening; includes Dirt Roads)
 - Public and Private Roads Used for Access (No Widening)
- Land Ownership**
- U.S. Forest Service
 - Private Land

NV ENERGY
BORDERTOWN TO CALIFORNIA 120 KV
TRANSMISSION LINE CONSTRUCTION,
OPERATION, AND MAINTENANCE
(COM) PLAN

0 2,000 4,000 Feet
1 in = 4,000 feet

T19N, R18E Washoe County, NV
NAD 1983 UTM Zone 11N

DRAWN BY: CJ	1ST REVIEW: JT	2ND REVIEW: MB
DATE: 5/12/2020		PROJECT NO: 203703160

Figure 1
Waterbody Crossings

Service Layer Credits: Copyright (c) 2014 Esri

Disclaimer: Stantec assumes no responsibility for data supplied in electronic format. The recipient accepts full responsibility for verifying the accuracy and completeness of the data. The recipient releases Stantec, its officers, employees, consultants and agents, from any and all claims arising in any way from the content or provision of the data.

APPENDIX C3

**Reclamation and Habitat Restoration
Plan**

**Reclamation and Habitat Restoration Plan
Bordertown to California 120 kV Transmission Line
Construction, Operation, and Maintenance (COM) Plan**

Prepared for:

NV Energy
6100 Neil Road
Reno, NV 89511

Prepared by:

Stantec Consulting Services Inc.
6995 Sierra Center Parkway
Reno, NV 89511

August 2020

Table of Contents

1.0	INTRODUCTION	1
2.0	OVERVIEW OF EXISTING ENVIRONMENT	2
2.1	Plant Communities.....	2
3.0	RECLAMATION AND RESTORATION PROTOCOLS	6
3.1	Responsible Parties	6
3.2	Design Features	6
3.2.1	Noxious Weeds (NW).....	6
3.2.2	Vegetation (VG).....	6
3.2.3	Herbicide Use (HE)	7
3.2.4	Forest Health (FH) – Insects and Disease.....	9
3.2.5	Water Resources and Soil (WA).....	9
3.2.6	Wildlife and Sensitive Wildlife Species (WL).....	9
3.2.7	Recreation/Roads/Transportation (RT).....	10
4.0	RECLAMATION OF CONSTRUCTION DISTURBANCE AREAS	11
4.1	ROW/Easement.....	11
4.2	Power Pole Structures	11
4.3	New Temporary Access Roads.....	11
4.4	Existing Access Roads.....	12
4.5	Staging Areas	13
5.0	SOIL REVEGETATION RECLAMATION METHODS	14
5.1	Topsoil.....	14
5.2	Seeding	14
5.2.1	Seed Bed Preparation and Application	15
5.2.2	Seeding Schedule	15
5.3	Mulching	15
5.4	Erosion Control.....	16
6.0	RECLAMATION MONITORING	17
6.1	Performance Criteria by Vegetation Type	17
6.2	Monitoring.....	17
7.0	REFERENCES	19

List of Figures

Figure 1 Vegetation Communities and Transects

List of Tables

Table 2-1	Acres of Vegetation Communities within the Variable-Width Corridor	2
Table 2-2	Plant Community Type Cover Summary	3
Table 2-3	Acres of Vegetation Communities within the ROW/Easement and Road Widening Corridors	4
Table 3-1	Minimum Buffers (ft) for Herbicide Application Near Aquatic Features	8



Table 5-1 Revegetation Seed Mix.....14

LIST OF ABBREVIATIONS

COM	Construction, Operations, and Maintenance
EIS	Environmental Impact Statement
kV	Kilovolt
NDA	Nevada State Department of Agriculture
NDOW	Nevada Department of Wildlife
NFS	National Forest System
Plan	Reclamation and Habitat Restoration Plan
PLS	Pure Live Seed
Project	Bordertown to California 120 Kilovolt Transmission Line Project
ROW	Right-of-Way
U.S.	United States
USFS	United States Forest Service



1.0 INTRODUCTION

NV Energy and its contractors will construct the Bordertown to California 120 Kilovolt (kV) Transmission Line Project (Project) in compliance with all federal, state, and local regulations as well as the National Environmental Policy Act, the Environmental Impact Statement (EIS) and Final Record of Decision, the United States (U.S.) Forest Service (USFS) Special Use Permit, and all other applicable permits. The Project area is in Washoe County, Nevada, and Sierra County, California, west and northwest of the city of Reno, Nevada. The northern boundary of the Project area is near Bordertown, Nevada, and U.S. Highway 395 and the southern boundary is near Interstate 80 between Verdi, Nevada, and Mogul, Nevada. The western boundary is roughly parallel with the California state line and the eastern boundary extends to the Peavine area generally east of Peavine Peak. The constructed 120 kV overhead transmission line will be approximately 11.9 miles long and will run between the existing Bordertown and California substations in Sierra County, California.

This Reclamation and Habitat Restoration Plan (Plan) is part of NV Energy's compliance obligation and is appended to the Construction, Operations, and Maintenance (COM) Plan. The objective of this Plan is to provide guidelines for activities prior to, during, and following construction of the Project that ultimately pertain to the successful reclamation of areas disturbed by implementation of the Project and restoration of vegetation communities and associated wildlife habitat in areas disturbed by Project activities.

Construction and reclamation practices will be guided by the State of Nevada Best Management Practices Handbook (NDEP 1994), the United States Department of Agriculture National Best Management Practices for Water Quality Management on National Forest System Lands (USDA 2012), the Truckee Meadows Construction Site Best Management Practices Handbook (Farr West 2015), and applicable sections of the Truckee Meadows Structural Controls Design and Low Impact Development Manual (NCE 2015). In addition, the USFS, City of Reno, and Washoe County issued special use permits for the construction, operation and maintenance of the transmission line may also contain reclamation conditions not mentioned in this Plan. Upon issuance of the special use permits, this Plan will be modified to incorporate any modifications and/or additional reclamation requirements not already included. NV Energy's approach to revegetation emphasizes conservation and enhancement of native vegetation, supplemental seeding, and erosion control. The reclamation methods described below pertain to the restoration of the plant communities that will be disturbed during Project construction. These protocols will be implemented by the construction contractor(s) and/or reclamation contractor during the reclamation of disturbed vegetation communities.



2.0 OVERVIEW OF EXISTING ENVIRONMENT

Plant communities in the Project area were characterized and mapped during field surveys that were conducted for vegetation, special status plants, and noxious and invasive weeds in May and July 2012. Additionally, plant community boundaries and species were further refined during field surveys conducted in July and August 2018. Information on the plant species and vegetation communities in the Project area are summarized from the following documents: Specialist Report: Vegetation Resources, Specialist Report: Special Status Plants, the EIS for the Project, and the Reference Vegetation Memorandum: Bordertown Transmission Line (USFS 2014, 2016, 2018 and Western Botanical Services, Inc. 2018, respectively). Information on plant species and vegetation communities in the Project area from the above mentioned surveys and the EIS for the Project were used to develop the reclamation seed mix and seeding density recommendations that are contained in this Plan.

2.1 PLANT COMMUNITIES

Several large-scale fires have burned across the region in the past three decades. Wildfire has caused an uneven distribution of tree size and age within the forested communities in the region. Shrub communities have also suffered the repeated effects of fire and have been converted to communities dominated by species that are adapted to disturbance. Following wildfires, vegetation communities may initially be dominated by weeds and annual grasses, such as cheatgrass (*Bromus tectorum*), which is found in almost all of the vegetation communities in the Project area (USFS 2018).

Biological disturbances of vegetation communities have also occurred from climatic variations (i.e., drought) resulting in insect infestations in forested communities from Jeffrey pine beetle (*Dendroctonus jeffreyi*), pine engraver beetle (*Ips pini*), fir engraver beetle (*Scolytus ventralis*), and mountain pine beetle (*Dendroctonus ponderosae*) often resulting in tree mortality particularly in the Dog Valley area (USFS 2018).

Sixteen vegetation communities were identified within the 300- to 600-foot-wide variable-width corridor or the right-of-way (ROW) and the road widening corridor. Table 2-1 presents the total acreage of vegetation communities within the variable-width corridor of the Project.

Table 2-1 Acres of Vegetation Communities within the Variable-Width Corridor

Vegetation Community	Total Acres
Annual Grasses and Forbs	176.3
Big Sagebrush	33.8
Bitterbrush-Sagebrush	233.4
Chaparral	98.4
Curl-Leaf Mountain Mahogany	6.0
Eastside Pine	42.8
Jeffery Pine	25.1
Low Sagebrush	22.0
Mixed Riparian Hardwood	2.4



Vegetation Community	Total Acres
Mountain Sagebrush	0.9
Quaking Aspen	6.5
Ruderal	16.6
Snowbrush	12.3
Urban Developed	8.5
Wet Meadow	12.4
Willow	6.9
Total	704.3

Source: USFS 2018

The bitterbrush-sagebrush community is the most abundant vegetation community within the variable width corridor of the Project; however, it is less abundant on the south aspect of Peavine Peak where the Project crosses.

Loss of vegetation cover will occur at pole sites, wire setup sites, staging areas, widened roads, new access roads, and within line clearance areas. As a result, during the 2018 vegetation surveys, five plant communities were identified requiring baseline data collection to be used for both designing erosion control and revegetation specifications as well as monitoring progress toward meeting performance criteria goals for revegetation and reclamation work. Baseline data collection transects were established in each of the identified vegetation community, with a minimum of two transects per vegetation community. The baseline data collection transects are required to comply with design feature Vegetation (VG) 7. Table 2-2 summarizes the plant communities and cover summaries identified as requiring baseline data collection during the 2018 field surveys and the associated baseline data collection transects. Figure 1 details the baseline data collection transect locations.

Table 2-2 Plant Community Type Cover Summary

Plant Community	Field Observed Cover Characteristics	Average Total Cover (including litter, gravel and rock)	Average Total Vegetative Cover	Vegetative Cover by Native Species	Baseline Data Collection Transects
Jeffery Pine Alliance	Vegetative cover was dominated by litter (pine needles). Non-native cover was dominated by cheatgrass and native cover was dominated by native perennial bluegrass (<i>Poa sp.</i>).	93%	20%	13%	Transects 6 and 7



Plant Community	Field Observed Cover Characteristics	Average Total Cover (including litter, gravel and rock)	Average Total Vegetative Cover	Vegetative Cover by Native Species	Baseline Data Collection Transects
Great Basin Mixed Chaparral	Vegetative cover was dominated by native shrubs, particularly mountain sagebrush (<i>Artemisia tridentata ssp vaseyana</i>) and tobaccobrush (<i>Ceanothus velutinus</i>). Litter dominated non-vegetative cover. Cheatgrass only occurred Transect 9.	91%	57%	54%	Transects 3, 8, and 9
Bitterbrush-Sagebrush Alliance	Vegetative cover was dominated by native shrubs and cheatgrass.	92%	60%	44%	Transects 1, 2, 5, 14, and 15
Rabbitbrush Alliance	Vegetative cover was dominated by native shrubs and forbs.	95%	78%	58%	Transects 4, 12, and 13
Ruderal	Vegetative cover was dominated by nonnative annual graminoids.	100%	93%	14%	Transects 10 and 11

Source: Western Botanical Services, Inc. 2018

The estimated plant community disturbance areas along the road widening corridors and the ROW/easement from the Project is presented in Table 2-3 below.

Table 2-3 Acres of Vegetation Communities within the ROW/Easement and Road Widening Corridors

Vegetation Community	Total Acres in ROW/Easement	Total Acres in Road Widening Corridors
Bitterbrush-Sagebrush	51.9	22.0
Eastside Pine	6.3	3.6
Jeffrey Pine	3.9	0.0
Mixed Conifer-Fir	0.0	0.2
Plantation	0.0	0.0
Aspen	1.9	0.8
Chaparral	15.1	0.9
Annual Grasses and Forbs	30.7	3.5
Big Sagebrush	3.8	0.4
Great Basin Mixed Scrub	0.0	2.3
Curl-leaf Mountain Mahogany	1.1	0.0
Low Sagebrush	3.7	0.0
Mountain Sagebrush	0.0	0.7
Ruderal	4.6	8.1
Snowbrush	0.7	0.0



Vegetation Community	Total Acres in ROW/Easement	Total Acres in Road Widening Corridors
Wet Meadow	3.0	0.0
Willow	1.5	1.3
Total	128.2	43.8

Source: USFS 2018



3.0 RECLAMATION AND RESTORATION PROTOCOLS

3.1 RESPONSIBLE PARTIES

NV Energy will have the overall responsibility of directing and monitoring the reclamation and habitat restoration actions for this Project and NV Energy's reclamation obligation will only be for up to five years. NV Energy's construction contractor(s) may retain the services of a reclamation specialist subcontractor to implement the reclamation protocols during and following construction.

3.2 DESIGN FEATURES

The Project EIS contains specific design features that pertain to reclamation and habitat restoration, as described below. In addition, Appendix C1 (Noxious Weed Plan) and Appendix C4 (Wildlife Protection Plan) also provide more details related to specific design features that are described below.

3.2.1 Noxious Weeds (NW)

NW 2. Monitoring and continued treatment in areas that were treated prior to construction will commence the first full growing season after Project implementation. Weed treatment will continue until disturbed areas are successfully restored (see restoration criteria detailed in VG 7). Weed treatment will continue during maintenance activities and within the ROW.

NW 4. When cut and fill is required to create access roads and structure sites, topsoil will be stockpiled and covered to prevent weeds from establishing in the soil. This topsoil will be re-spread during restoration.

NW 7. Restoration seed mixes will be certified as weed-free.

NW 8. All gravel and/or fill material will be certified as weed-free.

3.2.2 Vegetation (VG)

VG 4. Trees identified for removal will be whole tree yarded to log landings for disposal. Permits and/or contracts shall be issued prior to felling any trees greater than eight inches diameter at breast height (dbh). All logs and slash will be removed from National Forest System (NFS) land within six weeks to reduce insect and disease infestations. Woodchips not needed for restoration will also be removed from NFS land within six weeks.

VG 5. Where removal of vegetation other than trees is unavoidable, the vegetation will be cut at ground level to preserve the root structure and allow for potential sprouting.

VG 6. All areas of temporary ground disturbance that result from the construction or maintenance of the Project will be restored as required by the land management agency and per any applicable permits. Restoration will include restoring contours to their approximate pre-construction condition, stabilizing the area through seeding, mulching, placement of erosion control fabric, and installing erosion control features. Erosion control includes installing cross drains and placing water bars in the road, as needed.



VG 7. Successfully restored areas will be defined as:

Reference sites will be pre-established and approved by the USFS. Reference sites will include plant communities that are representative of the ecological site and must include plant communities that are in a late-seral and ecologically functioning condition. Appropriate reference sites will be determined by collecting baseline cover data to indicate plant succession and community structure.

3.2.3 Herbicide Use (HE)

- HE 1. Herbicides will be used in accordance with label instructions, except where project design features describe more restrictive measures. An herbicide use plan will be developed and included in the COM Plan.
- HE 2. Prior to the start of application, all spray equipment will be calibrated to ensure accuracy of the delivered amounts of herbicide. Equipment used during herbicide application will be regularly inspected to insure it is in proper working order.
- HE 3. Herbicide spray applications will not occur when wind velocity is five miles per hour or greater to further minimize the potential for drift.
- HE 4. Herbicide applications will not be conducted during rain or immediately following rain when soil is saturated or runoff or standing water is present. Application will occur only under favorable weather conditions, defined as:
 - a) 30% or less chance of precipitation on the day of application based upon National Weather Service weather forecasting for the Reno area;
 - b) If rain, showers or light rains are predicted within 48 hours, the amount of rain predicted shall be no more than ¼ inch of rain; and
 - c) Rain does not appear likely at the time of application.
- HE 5. Preparation of herbicides for application, including mixing, filling of wands and rinsing of spray equipment, will take place outside of wetlands, meadows, riparian zones, wells and springs, and other sensitive sites, and more than 300 feet from surface water. Herbicide preparation will occur only on level, disturbed sites such as the interior of landings.
- HE 6. A spill cleanup kit will be readily available whenever herbicides are transported or stored. A spill kit will be carried by the applicator at all times when using the wicking application method.
- HE 7. Low nozzle pressure (<25 pounds per square inch), and a coarse spray (producing a median droplet diameter of >500 microns) will be used in order to minimize drift during herbicide applications.
- HE 8. Prior to treatments in areas of concentrated public use, the public will be notified about upcoming herbicide treatments via posting signs.



- HE 9. The herbicide spray nozzle will be kept as close to target plants as possible (within 20 inches) while achieving uniform coverage in order to limit overspray and drift to non-target vegetation.
- HE 10. Where riparian vegetation communities occur, herbicide application will be limited to directed foliar spray or wiping methods and spray will be directed away from native vegetation.
- HE 11. Herbicide treatments will not occur within 500 feet of sensitive plant occurrences.
- HE 12. Herbicide application within wet meadows will be limited to treating invasive plant infestations that occupy less than 100 square feet. Herbicide applications will be limited to wiping techniques with aminopyralid, chlorsulfuron, and glyphosate and treatment of the following high priority species: Canada thistle (*Cirsium arvense*), yellow star thistle (*Centaurea solstitialis*), Russian knapweed (*Acroptilon repens*) or tall whitetop (*Lepidium latifolium*) which are difficult to eradicate with non-chemical means. Meadows will be surveyed for special status plant species prior to any chemical treatments and will be monitored post-treatment to determine effects to non-targeted vegetation.
- HE 13. Herbicide application will not occur within the established buffers for aquatic features shown in Table 3-1.

Table 3-1 Minimum Buffers (ft) for Herbicide Application Near Aquatic Features

Herbicide	Application Method	Dry Aquatic Features	Streams ¹ or Ditches with Water ²	Wetland or Meadow
Aminopyralid	Spot & directed foliar spray	25	25	100
	Wiping	15	150	15
Chlorsulfuron	Directed foliar spray	25	100	100
	Wiping	15	15	15
Glyphosate	Directed foliar spray or drizzle	0	25	25
	Cut stump or wiping	0	15	15
Imazapic	Directed foliar spray	25	75	75
Triclopyr (TEA)	Directed foliar spray	25	75	75
	Wiping or cut stump	15	15	15
Clopyralid	Spot & directed foliar spray	25	50	50
	Wiping	15	15	15

¹As measured from the edge of the stream channel. If a defined channel is not present (draws do not have defined channels), measurement is from the bottom of the feature.

²As measured from the edge of the wet area or the meadow vegetation, whichever is greater. Limited conditions allowing for herbicide application within meadows are described in HE 12.

- HE 14. Herbicide application is limited to targeted treatments directed at the plant (spot treatments of the immediate area surrounding the plant are allowed with aminopyralid and clopyralid, only) using a backpack sprayer; broadcast spray methods that dispense chemical over a non-localized area will not be used.

HE 15. Avoid application of Aminopyralid and Clopyralid sprayed mulch materials on revegetation sites.

3.2.4 Forest Health (FH) – Insects and Disease

FH 1. To reduce the build-up or residual tree mortality by pine engraver beetles (*Ips pini*), and reduce fuel loading the following measures shall occur:

- a) Trees greater than three inches dbh (whether in accessible or inaccessible areas) shall be removed (after proper permitting) to established log landings. All slash shall be chipped and hauled off of NFS land for disposal. All logs and slash shall be removed from NFS lands within six weeks of cutting. Any incidental breakage during whole-tree yarding that is three inches in diameter or greater shall be removed and taken off of NFS lands with other residual slash materials.
- b) Timing: In areas where material three inches or greater in diameter must be left on site, cutting shall only occur from August 1 through December 31. Lopping and scattering may only occur with limited material and at the approval of the USFS. All material that is approved to be lopped and scattered must be scattered to ensure slash depth is no greater than six inches. There are no timing restrictions for dead trees.

3.2.5 Water Resources and Soil (WA)

WA 6. Topsoil removed from foundation holes and structure sites will be separated and stockpiled at the edge of active work areas to salvage the seed bank.

WA 10. Stream crossings will be designed for a normal range of flows for the site, and crossings that must remain in place during high runoff seasons will be stabilized. However, all crossings will be temporary and will be removed at the end of the construction season. The water body profile and substrate will be restored when the crossing is removed.

Improvements to existing crossings will be removed or stabilized and retained as part of the Reclamation and Habitat Restoration Plan.

3.2.6 Wildlife and Sensitive Wildlife Species (WL)

WL 7. To aid in providing browse for wintering mule deer, post construction revegetation in areas mapped as crucial winter and winter spring high use habitat will include seed mix of brush species preferred by mule deer (i.e., bitterbrush, mountain big sagebrush, mountain mahogany, serviceberry, snowberry, and Wyoming big sage) as well as appropriate forbs and grasses.

WL 8. To ensure that impacts to wildlife habitat, particularly mule deer are no more than minor, vegetation that would be permanently lost or temporarily disturbed from the Project, would require creation of or improvement of on or offsite wildlife habitat. To achieve this, NV Energy will fund a habitat restoration account that includes the cost of restoring three acres to every one acre of habitat that is permanently or temporarily disturbed. The account will be administered by Nevada Department of Wildlife (NDOW) or a Sierra Front Wildlife



Working Group that would include NDOW, Washoe County, USFS, Bureau of Land Management, City of Reno and other interested participants.

3.2.7 Recreation/Roads/Transportation (RT)

- RT 3. All new access roads (i.e., spur roads and centerline travel roads) specifically constructed for this Project will be re-contoured and reclaimed and will have a physical closure installed to prevent motorized access immediately following the completion of construction and restoration. The types of closure and design specification used will be approved by the USFS prior to installation.
- RT 4. Physical barriers such as boulders or natural features designed to harmonize with the natural environment of the surrounding area will be installed to prevent unauthorized vehicle use from occurring on restored roads. The use of gates or other such structures for this purpose will be avoided unless determined necessary by the USFS. Design specifications will be provided by the USFS.
- RT 5. Maintenance activities which cause a road to be opened to unauthorized vehicles or damage to restoration improvements will need to be assessed and barriers reinstalled as needed at the expense of NV Energy.
- RT 6. Restored roads will require a signage and monitoring plan implemented by NV Energy for compliance with the closure which will include inspecting the barricade areas to determine the effectiveness of the blockades at preventing unauthorized motorized vehicle use of the restored access roads. Signs will notify the public that construction access roads are closed and are being restored. Signs will be replaced by NV Energy if vandalism occurs to the signs. Design specifications will be provided by the USFS.
- RT 7. If unauthorized vehicle use occurs on restored roads, barricades and reclamation will be monitored for effectiveness and remedial measures taken. Monitoring will continue until disturbed areas are successfully restored.
- RT 9. All construction vehicle movement will be restricted to the transmission line ROW/easement, pre-designated access roads, public roads, and private roads. All existing roads will be left in a condition equal to or better than their preconstruction condition.

4.0 RECLAMATION OF CONSTRUCTION DISTURBANCE AREAS

All areas of temporary ground disturbance that result from the construction or maintenance of the Project will be restored as required by the land management agency and per any applicable permits.

4.1 ROW/EASEMENT

Prior to construction, noxious weeds will be inventoried, mapped, and treated within the ROW/Easement and areas within 100 feet of Project ground disturbance. Vegetation will not be routinely removed from the permanent ROW/easement except as needed at power pole structure sites and wire stringing sites. During vegetation clearing operations, vegetation will be mowed leaving root systems intact wherever possible. In forested areas, whole trees will be removed using heavy equipment where terrain and slope stability permits and skidded to log landings for disposal. In areas that are not accessible with equipment or with excessive slopes and highly erodible soils, trees would be removed by helicopter. All slash will be chipped and removed from NFS land within six weeks to reduce insect and disease infestations. Tree clearing will be performed in a manner that will not interfere with reclamation activities or inhibit revegetation.

4.2 POWER POLE STRUCTURES

A pole site is the area needed for the construction and installation of the pole structure and will be 0.5 to one-acre in size depending on the type of pole structure. Clearing of vegetation at pole structure sites will be limited to the area excavated for the installation of the pole structures. Pole structure sites in steeper terrain (greater than 10 percent to 12 percent slopes) will be graded level for safe operation of equipment. Equipment pads will not be recontoured, but reseeded so that the pad will be available for future maintenance of the pole.

Excavation for poles and foundations will typically occur with a truck or track-mounted power auger; however, backhoe excavation and blasting may also be used as alternative excavation methods as required. Topsoil removed from foundation holes and structure sites will be separated and stockpiled at the edge of active work areas to salvage the seed bank.

At power pole structure sites in steep terrain, an approximate 0.25-acre level pad will be retained for equipment access to structures for maintenance inspections and repairs and the rest of the structure site disturbance will be recontoured. All structure site disturbance (including the equipment pads retained for future inspections) will be de-compacted, stabilized and reseeded with USFS-approved seed mixes. Different seed mixes and seeding rates will be required for various portions of the Project depending upon the vegetation community, substrate, and elevation. Revegetation methods including seeding is discussed further in Section 5.0.

4.3 NEW TEMPORARY ACCESS ROADS

New temporary access roads (i.e., centerline travel road and spur roads) will be constructed to pole sites, transmission wire setup sites, and staging areas when there are no existing roads available. Access roads will be 30 feet wide and located within the 300- to 600-foot-wide corridor



(variable-width corridor). The variable-width corridor will be centered on the transmission line and will measure 300 feet wide where slopes are 10 percent or less, and 600 feet wide where slopes are greater than 10 percent. While new access roads wider than 30 feet will not be expected, occasional widening beyond 30 feet may be necessary in areas where extensive blading and side cuts are required.

All temporary construction access roads constructed on NFS land will be recontoured and reclaimed. All existing authorized NFS roads and motorized trails that are widened for construction access will be reclaimed and returned to the original roadbed. Non-designated roads on NFS land that will be widened and used for construction access will be reclaimed and reseeded. Restoration will include recontouring roads, installing erosion control features such as drain dips, ripping, chipping, and seeding. Logs, branches, pine needles, brush, and rocks may be used to disguise the road for restoration purposes or other techniques approved by the USFS. Restoration success will be monitored until restoration is deemed successful by the USFS.

Temporary roads will be constructed primarily by mowing or masticating vegetation using a grader, hydro ax, brush hog, or other suitable equipment in a manner that leaves root systems intact to encourage regrowth and minimize soil erosion. Whole tree removal will be required where new access roads cross forested areas. Rocks or other obstructions will be bladed. If rocks cannot be removed with heavy equipment, explosives may be used.

Following construction, all temporary access roads will be recontoured and stabilized by seeding, mulching, placement of erosion control fabric, and installing erosion control features such as water bars. Where deemed appropriate by the USFS, roads near sensitive resources may not be recontoured in order to avoid inadvertent disturbance to resources. Barriers will be installed on all restored access roads located on NFS land to prevent unauthorized vehicle use. Restored roads will require a signage and monitoring plan for compliance with closure which will include inspecting the barricade areas to determine the effectiveness of the blockades at preventing unauthorized motorized vehicle use of the restored access roads. Signs will notify the public that construction access roads are closed and are being restored and will be replaced as needed if vandalism occurs.

NV Energy will monitor the restored roads for unauthorized vehicle use and will ensure the effectiveness of barricades preventing unauthorized use.

Vehicle access for transmission line maintenance is expected to be rare as the poles will be made of fire resistant metal. Access will be necessary approximately every 10 years for close visual inspections and tree removal within the line clearance area. There are no temporary access roads proposed to be kept for operation and maintenance of the new transmission line.

4.4 EXISTING ACCESS ROADS

Existing roads will be used for construction and maintenance access as much as possible; however, some existing roads will be widened up to 30 feet, including cut and fill slopes to accommodate construction equipment. All designated NFS roads widened for construction or maintenance access will be restored to the original roadbed and will be left in a condition equal to or better than their preconstruction condition. Non-designated roads on NFS land that will be widened and used for construction access will be reclaimed and reseeded.



Restoration will include recontouring roads, installing erosion control features such as drain dips, ripping, chipping, and seeding. Logs, branches, pine needles, brush, and rocks may be used to disguise the road for restoration purposes or other techniques approved by the USFS. Restoration success will be monitored until restoration is deemed successful by the USFS.

4.5 STAGING AREAS

Two staging areas will be established to support construction activities for the Project and will measure approximately 500 feet in length by 500 feet in width. The staging areas will use previously disturbed ground and will not be located on NFS land. Vegetation will be removed as need for site preparation and will generally consist of mowing or masticating shrub and grass vegetation in a manner that leaves the root system intact.

Surplus materials, equipment, and construction debris will be removed from staging areas at the completion of construction activities. NV Energy and the construction contractor(s) are responsible for appropriate disposal of all waste products. All wastes generated, including trash, sanitary waste, scraps, salvage materials, hazardous materials, and petroleum products will be disposed of in accordance with applicable local, state, and federal regulations. All man-made construction debris will be removed and disposed of as appropriate at permitted landfill sites.

Following Project construction, staging areas will be restored to their approximate pre-construction condition. Restoration will include restoring contours to their approximate pre-construction condition, stabilizing the area through seeding, mulching, placement of erosion control fabric, and installing erosion control features. Revegetation may include incorporation of chips into the soil, as needed.



5.0 SOIL REVEGETATION RECLAMATION METHODS

The following discusses reclamation methods to be used during Project reclamation activities.

5.1 TOPSOIL

In areas where significant grading will be required, topsoil will be stockpiled and segregated for later reapplication.

Salvaged topsoil and organic matter consist of a mixture of soil, vegetation, and other organic matter salvaged from the upper layer of the existing soil that typically is rich in organic matter and vegetation and usually distinct in color from deeper layers of soil. For this Project, an unconsolidated bulk material mixture consisting of roots and soil will be considered topsoil and organic matter. Topsoil will be maintained with temporary best management practices as detailed in the storm water pollution prevention plan. In no case will visqueen or plastic sheeting be allowed. For piles stockpiled more than two months, annual ryegrass at 10 Pure Live Seed (PLS) pounds per acre will be applied, which will be raked to incorporate into the stockpile.

5.2 SEEDING

All seed will conform with all laws and regulations pertaining to the sale and shipment of seed required by the Nevada State Department of Agriculture (NDA) and the Federal Seed Act. All shipments of seed will be reported to the NDA and are subject for inspection of noxious weeds.

Seed used for reclamation will be certified 100 percent weed free and will have a minimum PLS as specified in Table 5-1. Seeds used will not include any seed of cheatgrass, sweet clover (*Melilotus officinalis*), and Russian thistle (*Salsola tragus*) and crop seed will not exceed 0.25 percent.

Table 5-1 Revegetation Seed Mix

Botanical Name	Common Name/Variety	PLS pounds/acre
<i>Achnatherum hymenoides</i>	Indian ricegrass (nezpar/native)	2.00
<i>Achnatherum occidentale</i>	Western needlegrass	1.00
<i>Agropyron cristatum</i>	Crested wheatgrass	3.00
<i>Argemone munita</i>	Flatbud pricklypoppy	0.25
<i>Artemisia tridentata ssp vaseyana</i>	Mountain sagebrush	0.50
<i>Artemisia tridentata ssp wyomingensis</i>	Wyoming sagebrush	0.50
<i>Cercocarpus ledifolius</i>	Curl-leaf mountain mahogany	1.00
<i>Leymus cinereus</i>	Great Basin wildrye	4.00
<i>Elymus elymoides</i>	Bottlebrush squirreltail	3.00
<i>Ericameria nauseosa</i>	Rubber rabbitbrush	0.50
<i>Eriogonum umbellatum</i>	Sulphur buckwheat	1.00
<i>Lolium multiflorum</i>	Annual rye	4.00
<i>Lupinus argenteus</i>	Silvery lupine	3.00
<i>Monardella odoratissima</i>	Pale monardella	0.50



Botanical Name	Common Name/Variety	PLS pounds/acre
<i>Poa secunda</i>	Sandberg bluegrass	1.00
<i>Purshia tridentate</i>	Antelope bitterbrush	1.00
<i>Sphaeralcea grossulariifolia</i>	Gooseberryleaf globemallow	1.00
Total		27.25

Source: Western Botanical Services, Inc. 2019

5.2.1 Seed Bed Preparation and Application

Seed bed preparation will include de-compacting all compacted soils to achieve 85 percent or less compaction. Rippers or tines will be used to the depth of compaction, which is estimated to be six to 12 inches. Tilling will not be used as ripping perpendicular to the flow line will be the preferred method. Salvaged topsoil will be applied and incorporated as available.

Seeds will be uniformly hand broadcast with hand-held seeders and incorporated by raking, harrowing, or chaining to cover seed to a depth of ¼-to a ½-inch in all disturbed soils with the revegetation seed mix detailed in Table 5-1. Seeders can also be truck-mounted or shoulder models to insure even applications. Seeding will not occur under conditions that would allow the seed to become windborne (generally winds greater than five miles per hour).

5.2.2 Seeding Schedule

Typically seeding will take place in the fall, before snowfall, as snow cover will provide adequate moisture for the seeds to germinate in the spring. The seeding schedule will be refined in response to weather, site conditions, and the construction schedule. Seeding will be coordinated with other reclamation activities and will occur as soon as possible after final grading and topsoil replacement, if weather conditions and the season are suitable.

5.3 MULCHING

Mulch will consist of salvaged native material from the Project area including pine needles and forest duff and in no case will material be removed from undisturbed, adjacent plant communities. Mulch material can also include slash. All organic materials removed during the clearing and grubbing operation including, but not limited to, pine needles, leaves, duff, trees smaller than six inches in diameter at an elevation of five feet above existing ground, stumps, and suitable roots shall be processed and stockpiled and used for mulch as part of the revegetation work. The contractor shall make allowances for chipping larger organic materials such as trees, suitable roots, branches, and stumps so that these materials can be used for revegetation efforts.

Construction material and debris developed during construction activities shall be considered unsuitable and disposed of outside the ROW in an approved location. All disturbed soils will be covered with native mulch to achieve 85 percent cover, one layer deep. If necessary, to achieve specified cover, imported mulch will be used including wood chips or tub grindings with a particle size between 0.5 and two inches in length and not less than 0.5 inches in width and 0.125 inches in thickness, with at least 95 percent conforming to specified sizes. All material will be clean from rock, garbage, weeds, or other deleterious material.



5.4 EROSION CONTROL

No trees will be removed/fell unless the tree has been marked for removal. Trees will be harvested in such a manner as not to injure standing trees and plants which are to be preserved. For all slopes greater than 3:1, erosion control netting will be installed. Erosion control blankets will be 100 percent coir fiber twine, 0.30 inches thick, 6.6 feet by 164 feet, and approximately 50 percent open area of weave (70 or 700 or product equal).

Erosion control netting will be installed as follows:

- At the top of the slope, a six-inch by six-inch trench will be excavated;
- A blanket will be placed in the trench so that the edge of the blanket extends six inches beyond the top of the trench;
- The blanket will be anchored with hardwood stakes on one-foot centers and then the trench backfilled and loose soil compacted;
- Extra blanket will be folded over the blanket and native fill placed over the blanket;
- The edges of adjacent parallel rolls will be overlapped every six inches and stapled every three feet.
- If blankets must be spliced, blankets will be placed end-over-end (shingle style) with two-foot overlap. Overlapped areas will be stapled through, approximately one foot on the center; and
- Hardwood stakes (12 inches in length) will be installed down the slopes in a diamond pattern either every six-inch or 12-inch, as needed (an average of two stakes per square yard).

6.0 RECLAMATION MONITORING

6.1 PERFORMANCE CRITERIA BY VEGETATION TYPE

Restoration success will be monitored by NV Energy until it is deemed successful by the USFS. Successfully restored areas will be defined as:

“Reference sites will be pre-established and approved by the USFS. Reference sites will include plant communities that are representative of the ecological site and must include plant communities that are in a late-seral and ecologically functioning condition. Appropriate reference sites will be determined by collecting baseline cover data to indicate plant succession and community structure (USFS 2018).”

The reclamation contractor will maintain all vegetation installed to meet the following warranty in accordance with the baseline data from the EIS for the following community types and the baseline data collection transects discussed in Section 2.1.

- Jeffrey Pine Alliance: Achieve 9 percent native vegetative cover;
- Great Basin Mixed Chaparral Transition Alliance: Achieve 38 percent native vegetative cover;
- Bitterbrush – Sagebrush Alliance: Achieve 31 percent native vegetative cover;
- Rabbitbrush Alliance: Achieve 41 percent native vegetative cover; and
- Ruderal: Achieve 10 percent native vegetative cover.

Monitoring will continue following reclamation until success criteria is met. Sites where revegetation is not fully restored after approximately five years will be mitigated by improving habitat in other onsite areas or through off-site habitat restoration projects using mitigation funds provided by NV Energy.

6.2 MONITORING

Monitoring will be conducted annually. Post-construction monitoring will continue following reclamation until success criteria are met. If monitoring indicates that Project-affected sites are trending toward successfully meeting soil, vegetation, invasive weeds, and other criteria, monitoring may be conducted less frequently (e.g., every two or three years) subsequently, until success criteria are met. Objectives of monitoring include the following:

- Qualitatively describe the status of revegetation in areas disturbed by the Project.
- Qualitatively survey areas disturbed to identify and remedy areas experiencing revegetation failure.
- Document and map areas where revegetation is not progressing in a desired direction; assess the severity of the problems.
- Quantitatively sample and evaluate representative reclamation areas and reference sites (i.e., baseline data collection transects) to determine whether or not success criteria are met or whether remedial measures are necessary. Monitoring will be conducted using the



point-intercept sampling method with 100-foot transects with sampling occurring every one-foot along the transect. Measurements will include total percent cover (including litter, gravel, and rock), total vegetative cover, and vegetative cover by native species.

If monitoring indicates that sites disturbed by the Project have not been met required reclamation criteria, or are not trending toward meeting reclamation criteria, the erosion control, revegetation, or invasive weed control plans may need to be revised (e.g., schedule, seed mixes, treatments, preparation methods). Remedial measures will be implemented as soon as practical in problem areas. Remedial measures will be determined on a case-by-case basis and may include measures such as supplemental seeding, mulching, additional weed control measures, use of matting, or other erosion control measures, as approved in consultation with the USFS and NV Energy.



7.0 REFERENCES

- Farr West Engineering. 2015. The Truckee Meadows Construction Site Best Management Practices Handbook. City of Reno, City of Sparks and Washoe County. February 2015.
- NCE. 2015. Truckee Meadows Structural Controls Design and Low Impact Development Manual. City of Reno, City of Sparks and Washoe County. April 2015.
- Nevada Division of Environmental Protection (NDEP). 1994. Best Management Practices Handbook. Nevada Department of Conservation and Natural Resources, Division of Environmental Protection. Accessed March 2019 online at:
<https://ndep.nv.gov/uploads/water-nonpoint-docs/NVBMPHandbook1994.pdf>.
- United States Department of Agriculture (USDA). 2012. National Best Management Practices for Water Quality Management on National Forest System Lands. April 2012.
- United States Forest Service (USFS). 2014. Specialist Report: Vegetation Resources. Bordertown to California. 120 kV Transmission Line Project. Sierra County, California and Washoe County, Nevada. Humboldt-Toiyabe National Forest. Carson Ranger District. September 2014.
- United States Forest Service (USFS). 2016. Specialist Report: Special Status Plants. Bordertown to California. 120 kV Transmission Line Project. Sierra County, California and Washoe County, Nevada. Humboldt-Toiyabe National Forest. Carson Ranger District. October 2016.
- United States Forest Service (USFS). 2018. Final Environmental Impact Statement. Bordertown to California 120 kV Transmission Line Project. Humboldt-Toiyabe National Forest, Carson Ranger District Sierra County, California, and Washoe County, Nevada. June 2018.
- Western Botanical Services, Inc. 2018. Reference Vegetation Memorandum. Bordertown Transmission Line. Washoe County, Nevada. October 26, 2017. Revised February 1, 2018.
- Western Botanical Services, Inc. 2019. Special Technical Specifications for Bordertown to California 120 kV Transmission Line Project. March 2019.

FIGURE

V:\2037\Active\203703160_03_data\gis\mxd\Baseline_Data_Collection_Transsects_Fig_C3-1_Preliminary_Figures\Fig_C3-1_Baseline_Data_Collection_Transsects_1x17P.mxd Revised: 2019-04-10 By: cfrjohnson

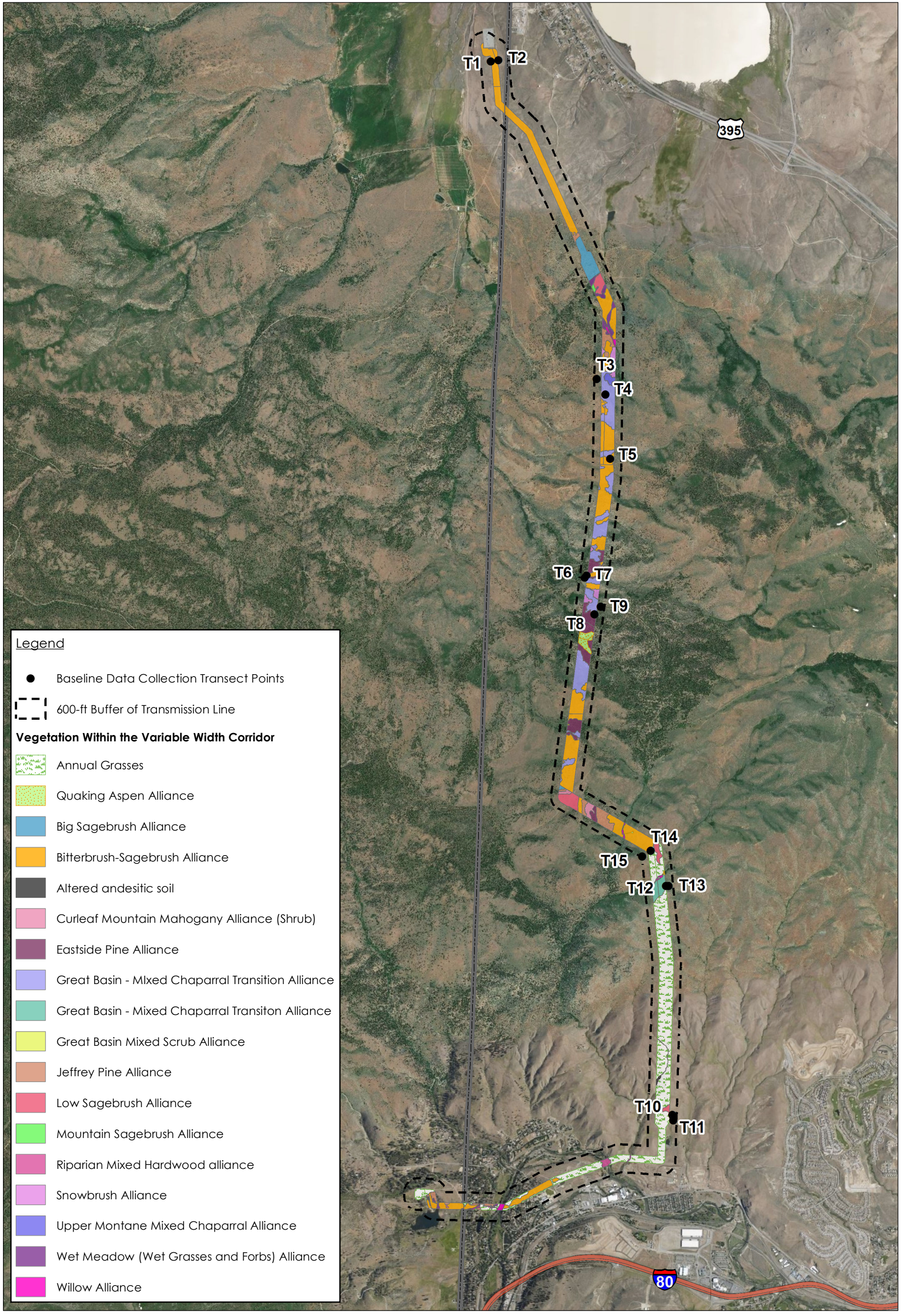

Legend

- Baseline Data Collection Transect Points
- 600-ft Buffer of Transmission Line

Vegetation Within the Variable Width Corridor

- Annual Grasses
- Quaking Aspen Alliance
- Big Sagebrush Alliance
- Bitterbrush-Sagebrush Alliance
- Altered andesitic soil
- Curleaf Mountain Mahogany Alliance (Shrub)
- Eastside Pine Alliance
- Great Basin - Mixed Chaparral Transition Alliance
- Great Basin - Mixed Chaparral Transition Alliance
- Great Basin Mixed Scrub Alliance
- Jeffrey Pine Alliance
- Low Sagebrush Alliance
- Mountain Sagebrush Alliance
- Riparian Mixed Hardwood alliance
- Snowbrush Alliance
- Upper Montane Mixed Chaparral Alliance
- Wet Meadow (Wet Grasses and Forbs) Alliance
- Willow Alliance

N

Stantec

0 2,000 4,000 Feet
1 in = 4,000 feet

Sierra County, CA & Washoe County, NV
NAD 1983 UTM Zone 11N

DRAWN BY: CJ	1ST REVIEW: JT	2ND REVIEW: KC
DATE: 4/10/2019		PROJECT NO: 203703160

NV ENERGY
BORDERTOWN TO CALIFORNIA 120 KV
TRANSMISSION LINE CONSTRUCTION,
OPERATION, AND MAINTENANCE
(COM) PLAN

Figure 1
Baseline Data
Collection Transects

Disclaimer: Stantec assumes no responsibility for data supplied in electronic format. The recipient accepts full responsibility for verifying the accuracy and completeness of the data. The recipient releases Stantec, its officers, employees, consultants and agents, from any and all claims arising in any way from the content or provision of the data.

Service Layer Credits: 2015 National Agriculture Imagery Program (NAIP)

APPENDIX C4
Wildlife Protection Plan

**Wildlife Protection Plan
Bordertown to California 120 kV Transmission Line
Construction, Operation, and Maintenance (COM) Plan**

Prepared for:

NV Energy
6100 Neil Road
Reno, Nevada 89511

Prepared by:

Stantec Consulting Services Inc.
6995 Sierra Center Parkway
Reno, Nevada 89511

August 2020

Table of Contents

1.0	INTRODUCTION	1
1.1	Regulatory Requirements	1
1.1.1	Federal Endangered Species Act	1
1.1.2	Migratory Bird Treaty Act.....	1
1.1.3	Humboldt-Toiyabe National Forest	2
1.1.4	Bureau of Land Management Eagle Lake Field Office.....	3
1.1.5	California Endangered Species Act	3
1.1.6	California Fish and Game Code - Fully Protected Species	3
1.1.7	California Species of Special Concern.....	3
1.1.8	State of Nevada Sensitive Species.....	3
2.0	OVERVIEW OF WILDLIFE IN PROJECT AREA	5
2.1	Wildlife Habitat.....	5
2.2	Management Indicator Species.....	5
2.3	General Wildlife	6
2.3.1	Mammals.....	6
2.3.2	Birds.....	6
2.3.3	Reptile and Amphibians.....	7
2.3.4	Aquatic Species.....	7
2.3.5	General Wildlife Habitat Loss	7
2.4	Special Status Wildlife Species	8
2.4.1	Special Status Wildlife Species Habitat Loss.....	10
3.0	PROTECTIVE MEASURES	12
3.1	Construction Phase.....	12
3.1.1	General Wildlife (General Practices [GP]).....	12
3.1.2	Sensitive Wildlife Species.....	12
3.1.3	Migratory Bird Species	13
3.1.4	Raptors	13
3.1.5	Mule Deer.....	13
3.1.6	Lahontan Cutthroat Trout	14
3.1.7	Avoidance Timeframes.....	14
3.1.8	Change Evaluation	14
3.2	Reclamation Phase.....	14
3.2.1	Habitat Restoration.....	14
4.0	REFERENCES	16

List of Figures

Figure 1 LCT Habitat Avoidance Areas

List of Tables

Table 2-1	Wildlife Habitats within the Project ROW/Easement.....	7
Table 2-2	Special Status Wildlife Species Potential for Occurrence in the Project Area.....	8
Table 2-3	Special Status Wildlife Species within the Project ROW/Easement.....	11



LIST OF ABBREVIATIONS

APLIC	Avian Power Line Interaction Committee
BLM	Bureau of Land Management
CDFW	California Department of Fish and Wildlife
dbh	Diameter at breast height
EIS	Environmental Impact Statement
ESA	Endangered Species Act
GP	General Practices
kV	Kilovolt
LCT	Lahontan cutthroat trout
LRMP	Land and Resource Management Plan
MBTA	Migratory Bird Treaty Act
MIS	Management Indicator Species
MIS	Management Indicator Species
NDOW	Nevada Department of Wildlife
NEPA	National Environmental Policy Act
PAC	Protected Activity Center
Plan	Wildlife Protection Plan
Project	Bordertown to California 120 Kilovolt Transmission Line Project
RMP	Resource Management Plan
ROD	Record of Decision
ROW	Right-of-Way
SNFPA	Sierra Nevada Forest Plan Amendment
SV	Plants and Sensitive Plant Communities
U.S.	United States
U.S.C.	U.S. Code
USFS	United States Forest Service
USFWS	U.S. Fish and Wildlife Service
VG	Vegetation
WL	Wildlife and Sensitive Wildlife Species



1.0 INTRODUCTION

NV Energy and its contractors will construct the Bordertown to California 120 Kilovolt (kV) Transmission Line Project (Project) in compliance with all federal, state, and local regulations as well as the National Environmental Policy Act (NEPA), the Environmental Impact Statement (EIS) and Final Record of Decision (ROD), the United States (U.S.) Forest Service (USFS) Special Use Permit, and all other applicable permits including the right-of-way (ROW) grant. The Project area is in Washoe County, Nevada, and Sierra County, California, west and northwest of the city of Reno, Nevada. The northern boundary of the Project area is near Bordertown, Nevada, and U.S. Highway 395 and the southern boundary is near Interstate 80 between Verdi, Nevada, and Mogul, Nevada. The western boundary is roughly parallel with the California state line and the eastern boundary extends to the Peavine area generally east of Peavine Peak. The constructed 120 kV overhead transmission line will be approximately 11.9 miles long and will run between the existing Bordertown and California substations in Sierra County, California.

This Wildlife Protection Plan (Plan) is part of NV Energy's compliance obligation and is appended to the Construction, Operations, and Maintenance (COM) Plan. The objective of this Plan is to address the wildlife and wildlife habitat design features and mitigation measures contained in the Project's Final EIS and to provide guidelines for activities prior to, during, and following construction to protect wildlife that may be directly or indirectly impacted by Project activities.

1.1 REGULATORY REQUIREMENTS

1.1.1 Federal Endangered Species Act

Pursuant to the federal Endangered Species Act (ESA) of 1973, the U.S. Fish and Wildlife Service (USFWS) determines if a species should be listed under the ESA, and whether these species should be listed as candidate, proposed, threatened, or endangered. Endangered means a species that is in danger of extinction throughout all or a significant portion of its range. Threatened species are likely to become endangered in the foreseeable future. The USFWS also maintains a list of species or subspecies (i.e., taxa) that may warrant listing as threatened or endangered and for which the agency has sufficient biological information to support a rule to list as threatened or endangered. These species are referred to as candidate species. Proposed species are species (taxa) for which the USFWS has published a proposal to list as threatened or endangered in the Federal Register.

1.1.2 Migratory Bird Treaty Act

The Migratory Bird Treaty Act of 1918 (MBTA) (16 United States Code [U.S.C.] 703-712) is administered by the USFWS and is the cornerstone of migratory bird conservation and protection in the United States. The MBTA provides that it shall be unlawful, except as permitted by regulations, "to pursue, take, or kill any migratory bird, or any part, nest or egg of any such bird" (16 U.S.C. 703). However, the MBTA does not regulate habitat. The list of species protected by



the MBTA was revised in March 2010 and includes almost all bird species (1,007 species) that are native to the United States.

1.1.3 Humboldt-Toiyabe National Forest

The Toiyabe National Forest Land and Resource Management Plan (LRMP) outlines the management direction of USFS land (USFS 1986). The regulations require that the USFS maintain viable populations of all vertebrate wildlife and fish species native to the USFS land. Management Indicator Species (MIS) were established to represent significant ecosystems on USFS land and the associated wildlife and fish that depend on the ecosystems. USFS biologists are required to periodically monitor species to ensure management directions are sustaining these ecosystems and species. A variety of factors are included in selecting MIS species. Generally, MIS species include those that are:

- Federally-listed threatened or endangered species;
- State-listed threatened or endangered species;
- Species representative of environmental suitability for other species; and
- Species having significant economic value.

The USFS sensitive species are plant and animal species identified by a Regional Forester for which population viability is a concern, as evidenced by:

- Significant current or predicted downward trends in population numbers or density; and
- Significant current or predicted downward trends in habitat capability that would reduce a species' existing distribution (Forest Service Manual 2670.5).

The Sierra Nevada Forest Plan Amendment (SNFPA) amended the Toiyabe LRMP in 2001 and in again in 2004 (USFS 2004). The SNFPA is designed to facilitate a regionally-consistent management of old forest ecosystem resources across USFS management boundaries and as such is called "framework" (e.g., Sierra Nevada Framework). The umbrella management also applies to other sensitive resources such as aquatic, meadow, and riparian ecosystems. The goals of the plan as they relate to wildlife resources include:

- Improve quantity and quality of useable habitat available for SNFPA species by increasing density of large trees, increase structural diversity of vegetation, and improve the continuity and distribution of old forests across the landscape; and
- Protect and restore desired conditions of aquatic, riparian, and meadow ecosystems in Sierra Nevada national forests.



1.1.4 Bureau of Land Management Eagle Lake Field Office

The Bureau of Land Management (BLM) manages habitat for wildlife and sensitive species outlined in the Eagle Lake Resource Management Plan (RMP) (BLM 2008a) through a variety of mechanisms. Under the authority of the Federal Land Policy and Management Act of 1976, public land must be managed to protect environmental quality and ecological relationships, and where appropriate, to preserve and protect their natural condition. Additionally, the BLM has signed Memorandums of Understandings with the California Department of Fish and Wildlife (CDFW) and Nevada Department of Wildlife (NDOW), where wildlife and wildlife habitat are managed in cooperation with either of these state agencies. Overall the goals for management of habitat for wildlife are to administer public land in a manner that promotes the recovery, restoration, maintenance, or enhancement of endemic wildlife populations.

In addition, the BLM Manual 6840.06 E states that native species may be listed as sensitive if they meet certain criteria (BLM 2008b). The BLM affords these sensitive species the same level of protection as federal candidate species. The BLM's policy for sensitive species is to avoid authorizing actions that would contribute to the listing of a species as threatened or endangered.

1.1.5 California Endangered Species Act

Pursuant to the California ESA, a permit from the CDFW is required for projects that could result in take of a plant or animal species that is state-listed as threatened or endangered. The California ESA defines "take" as an activity that would directly or indirectly kill an individual of a species. Authorization for take of state-listed species can be obtained through a California Fish and Game Code Section 2080.1 consistency determination or a Section 2081 incidental take permit.

1.1.6 California Fish and Game Code - Fully Protected Species

Protection of fully protected species is described in Sections 3511, 4700, 5050, and 5515 of the California Fish and Game Code. These statutes prohibit take or possession of fully protected species and do not provide for authorization of incidental take of fully protected species. The CDFW has informed nonfederal agencies and private parties that their actions must avoid take of any fully protected species.

1.1.7 California Species of Special Concern

The CDFW maintains a list of species that may be experiencing or formerly experienced population declines or range retractions that may lead to the species qualifying for California ESA protection, or had naturally small populations exhibiting high susceptibility to risk from factors that could lead to declines qualifying the species for protection under the California ESA. Species under this designation are not afforded legal protection.

1.1.8 State of Nevada Sensitive Species

The NDOW maintains a list of species thought to occur in limited numbers, limited distribution, or may be vulnerable to climatic or landscape scale changes. These are listed as both sensitive



species by Nevada Revised Statute 501.331 and within the Wildlife Action Plan (NDOW 2013) as Species of Conservation Priority. Some of these species are listed as sensitive by the BLM, USFS, or as a conservation priority bird species. Species under this designation are not afforded legal protection.



2.0 OVERVIEW OF WILDLIFE IN PROJECT AREA

2.1 WILDLIFE HABITAT

Bitterbrush-sagebrush (*Purshia tridentata-Artemisia spp.*) habitat is the most widely available wildlife habitat within the Project area. Other prevalent habitats within the variable-width corridor of the Project include forest (i.e., eastside pine), chaparral (with mixed scrub), and annual grasses. Aspen and riparian communities comprise less than one percent of the available habitat within the variable-width corridor of the Project. The Project has substantial non-native annual grasslands present within the variable-width corridor at 24 percent. Annual grasses consist primarily of cheatgrass and other non-native species, which are, in part, a reflection of past wildfires, particularly on the south facing slopes of Peavine Peak. Riparian habitats are available along the Truckee River, and as a result a diversity of species, particularly migratory bird species, may occur within the Project area. The Project area contains approximately 16 acres of aspen and willow habitat combined which provide potentially suitable habitat for a variety of avian species (USFS 2018).

2.2 MANAGEMENT INDICATOR SPECIES

Management Indicator Species (MIS) are identified in the Toiyabe Forest Plan as representing a group of species having similar habitat requirements. Essentially, these species are analogs for all other species that might occur within a given habitat. Managing for these species allows the USFS to preserve a diversity of habitats for more common wildlife. USFS biologists are required to periodically monitor species to ensure management directions are sustaining these habitats and species (USFS 2018).

The MIS expected to occur within the Project area include:

- Mule deer (*Odocoileus hemionus*);
- American marten (*Martes americana*);
- Yellow-rumped warbler (*Setophaga coronata*);
- Williamson's sapsucker (*Sphyrapicus thyrodeus*);
- Hairy woodpecker (*Leuconotopicus villosus*);
- Lahontan cutthroat trout (*Oncorhynchus clarkii henshawi*);
- Northern goshawk (*Accipiter gentilis*);
- Yellow warbler (*Setophaga petechia*); and
- Macroinvertebrates.



2.3 GENERAL WILDLIFE

A variety of common wildlife species occur within the Project area because of the diversity of habitat types that are available including: mammals, birds, reptiles and amphibians, and aquatic species. Species presented below either have been documented, are assumed to occur within the Project area, or could occur as ascertained using the California Wildlife Habitat Relationship System tool (USFS 2018).

2.3.1 Mammals

Mammalian species, in addition to mule deer, that commonly occur within the bitterbrush-sagebrush and chaparral habitats are badger (*Taxidea Taxus*), bobcat (*Lynx rufus*), mountain lion (*Puma concolor*), coyote (*Canis latrans*), and various rodents including California ground squirrel (*Otospermophilus beecheyi*), pocket mice, chipmunks, black-tailed jackrabbit (*Lepus californicus*), cottontail (*Sylvilagus spp.*), and yellow-bellied marmot (*Marmota flaviventris*). Within forest and aspen communities (i.e., habitats) American black bear (*Ursus americanus*), yellow-pine chipmunk, raccoon (*Tamias amoenus*), striped skunk (*Mephitis mephitis*), meadow jumping mouse (*Zapus hudsonius*), and deer mice (*Peromyscus spp.*) occur. Within or adjacent to the Truckee River, North American river otter (*Lontra canadensis*) and weasel (*Mustela spp.*) are expected to occur (USFS 2018).

2.3.2 Birds

The Project area is within the Pacific Flyway for migratory birds and within the contact between Great Basin and Sierra Nevada ecosystems. The Project area supports seasonal habitats for hundreds of birds. Aspen habitat is favored by a variety of cavity-nesting birds, such as bluebirds (*Sialia spp.*), sapsuckers (*Sphyrapicus spp.*), downy woodpeckers (*Picoides pubescens*), nuthatches (*Sitta spp.*), and chickadees (*Poecile spp.*). Species of birds that may occur within the brush and conifer habitat of the Project area include: house finch (*Haemorhous mexicanus*), Bewick's wren (*Thryomanes bewickii*), rock wren (*Salpinctes obsoletus*), Cassin's finch (*Haemorhous cassinii*), California quail (*Callipepla californica*), horned lark (*Eremophila alpestris*), western meadowlark (*Sturnella neglecta*), spotted towhee (*Pipilo maculatus*), dark-eyed junco (*Junco hyemalis*), northern flicker (*Colaptes auratus*), Steller's jay (*Cyanocitta stellari*), scrub jay (*Aphelocoma spp.*), black-headed grosbeak (*Pheucticus melanocephalus*), ruby-crowned kinglet (*Regulus calendula*), Brewer's blackbird (*Euphagus cyanocephalus*), and pine siskin (*Spinus pinus*) (USFS 2018).

The Truckee River provides habitat for waterfowl and water dependent birds such as mallard duck (*Anas platyrhynchos*), common merganser (*Mergus merganser*), wood duck (*Aix sponsa*), American dipper (*Cinclus mexicanus*), belted kingfisher (*Mergaceryle alcyon*), heron and swallows.

A number of raptors may be found within the available habitats. Raptors include red-tailed hawk (*Buteo jamaicensis*), American kestrel (*Falco sparverius*), sharp-shinned hawk (*Accipiter striatus*), Cooper's hawk (*Accipiter cooperii*), osprey (*Pandion haliaetus*), northern harrier (*Circus hudsonius*), northern saw-whet owl (*Aegolius acadicus*), great-horned owl (*Bubo virginianus*),



long-eared owl (*Asio otus*), and western screech owl (*Megascops kennicottii*), among others (USFS 2018).

2.3.3 Reptile and Amphibians

The Project area provides diverse brush habitat for reptiles and amphibians. Common species expected to occur are: Great Basin rattlesnake (*Crotalus oreganus lutosus*), western whipsnake (*Hierophis viridiflavus*), rubber boa (*Charina bottae*), gopher snake (*Pituophis catenifer*), Sierra garter snake (*Thamnophis couchii*), western yellow-bellied racer (*Coluber constrictor mormon*), western fence lizard (*Sceloporus occidentalis*), long-nosed leopard lizard (*Gambelia wislizenii*), zebra-tailed lizard (*Callisaurus draconoides*), and horned lizards (*Phrynosoma spp.*). Amphibians that may occur in riparian and wetland areas include western toad (*Anaxyrus boreas*), Sierran tree (chorus) frog (*Pseudacris sierra*), and American bullfrog (*Lithobates catesbeianus*) (USFS 2018).

2.3.4 Aquatic Species

A range of fish species may occur in Dog Creek and/or the Truckee River. According to NDOW, brown trout (*Salmo trutta*), Lahontan redbreast (*Richardsonius egregius*), mountain sucker (*Catostomus platyrhynchus*), mountain whitefish (*Prosopium williamsoni*), Paiute sculpin (*Cottus beldingii*), rainbow trout (*Oncorhynchus mykiss*), speckled dace (*Rhinichthys osculus*), and Tahoe sucker (*Catostomus tahoensis*) occur within the Project area (USFS 2018).

2.3.5 General Wildlife Habitat Loss

As a result of surface disturbance required for Project construction, general wildlife (including migratory birds) and MIS will encounter a loss of available habitat. Table 2-1 presents the acres of potential habitat within the Project ROW/easement that could be altered or lost from Project construction activities. Most surface disturbance from construction activities would be temporary and vegetation communities would be restored as detailed in the Project design features (Section 3.0).

Table 2-1 Wildlife Habitats within the Project ROW/Easement

Species	Vegetation/Habitat	Acres	
		USFS	Private
Yellow-rumped warbler, Hairy woodpecker, Williamson's sapsucker, Migratory birds	Mixed Conifer – White Fir (<i>Abies concolor</i>), Eastside Pine, and Jeffrey Pine (<i>Pinus jeffreyi</i>)	8.0	2.2
Mule deer (summer use), Migratory birds	Willow (Riparian)	0.1	1.4
Hairy woodpecker, Williamson's sapsucker, Mule deer (summer use includes Aspen), Migratory birds	Aspen and Mixed Riparian Hardwood	1.1	0.8



Species	Vegetation/Habitat	Acres	
		USFS	Private
Mule deer, Migratory birds	Mountain Mahogany (<i>Cercocarpus spp.</i>), Great Basin Mixed Scrub, Bitterbrush-Sagebrush, Chaparral-Snowbrush, and Mountain Sagebrush (<i>A. tridentata spp. vaseyana</i>)	50.7 ¹	18.1
Mule deer (Big sagebrush), Migratory birds	Big Sagebrush, Low Sage (<i>A. arbuscula</i>), Annual Grasses and Forbes and Ruderal, and Urban/Developed	1.7	41.1
Macroinvertebrates	Mixed Riparian Hardwood, Wet Meadow, and Water (Perennial Streams)	0	3.0 ²

¹ Includes approximately 15 acres of Bitterbrush-Sagebrush community on BLM-administered public land at the Bordertown Substation.

² Bull Ranch Creek, Truckee River.

Source: USFS 2018.

2.4 SPECIAL STATUS WILDLIFE SPECIES

Special status wildlife species that have the potential occur in the Project area are detailed in **Table 2-2**.

Table 2-2 Special Status Wildlife Species Potential for Occurrence in the Project Area

Special Status Wildlife Species	Status ¹	Habitat	Potential for Occurrence ²
American badger <i>Taxidea taxus</i>	SSC	Semi and arid shrubland or grassland with friable soils for digging burrows. Forages on pocket gophers, ground squirrels among others.	Likely to occur.
Spotted bat <i>Euderma maculatum</i>	SS, SSC	Roosts on cliffs ranging in habitats from high elevation to deserts. Foraging habitat are areas with moth abundance.	Could occur.
Townsend's big-eared bat <i>Corynorhinus townsendii townsendii</i>	SS, BS, SSC	Highly associated with caves and mines. Found primarily in rural settings from deserts to lower, mid to high-elevation mixed coniferous-deciduous forest and has also been reported to utilize buildings, bridges, rock crevices and hollow trees as roost sites.	Could occur.
Fringed myotis <i>Myotis thysanodes</i>	BS	Variety of habitats, generally lower elevation. Found roosting in trees, caves, buildings and mines. Forages on small beetles.	Could occur.
Pallid bat <i>Antrozous pallidus</i>	BS	Found in a variety of habitats from low elevation coniferous forest, woodlands to sagebrush. Forages on large ground dwelling insects but also moths.	Could occur.



Special Status Wildlife Species	Status ¹	Habitat	Potential for Occurrence ²
Dark-nosed small-footed myotis <i>Myotis melanorhinus</i>	BS, SSC	Habitat includes a variety of vegetation communities, roosts in caves, mines, and trees. Forages in open areas.	Could occur.
Yuma myotis <i>Myotis yumanensis</i>	BS	Habitat includes all landscapes including human built ones, roosts in outcrops, caves or buildings, forages primarily on emergent aquatic insects.	Could occur.
Sierra Nevada snowshoe hare <i>Lepus americanus tahoensis</i>	SSC	Inhabits mid-elevation riparian brush or young conifer thickets.	Could occur.
Northern goshawk <i>Accipiter gentilis</i>	MIS, SS, SNF, SSC, BS	Generally nests within late-seral stage montane forest; and in Nevada commonly nests in aspen.	Could occur.
Golden eagle <i>Aquila chrysaetos</i>	BGE, BS, FP	Nests on cliffs and rocky scarps with large expanses of hunting territory. Also nests in conifers when rocks are unavailable.	Known to occur.
Northern Harrier <i>Circus cyaneus</i>	SSC	Wide-ranging breeders in Nevada and northeastern California. Forages and nests within open habitats such as meadows and grasslands.	Known to occur.
Mountain quail <i>Oreortyx pictus</i>	SS	Montane shrub and riparian habitat with <i>Ceanothus</i> near water sources.	Known to occur.
Swainson's hawk <i>Buteo swainsoni</i>	SSC, BS, CT	Common habitat includes agricultural lands with open foraging habitat, and tall trees for nesting.	Could occur.
Burrowing owl <i>Athene cunicularia</i>	SSC, BS	This small owl nests and roosts within burrows, commonly excavated by fossorial mammals. Habitat is found within open grasslands, or other areas of open areas with sparse vegetation, whether natural or altered.	Could occur.
Long-eared owl <i>Asio otus</i>	SSC	Generally found within riparian, conifer or other woodland habitats which are open or adjacent to meadows and shrublands. Nest in old corvid or hawk nests in trees or on cliff faces.	Could occur.
Flammulated owl <i>Psiloscops flammeolus</i> (syn <i>Otus flammeolus</i>)	SS	Open coniferous forests, nest in dead trees with existing woodpecker holes.	Could occur.
White-headed woodpecker <i>Picoides albolarvatus</i>	SS	Mixed conifer forests, with a diversity of pine species (for seed consumption) and mixed ages, generally nest in dead standing trees.	Known to occur.



Special Status Wildlife Species	Status ¹	Habitat	Potential for Occurrence ²
Yellow warbler <i>Setophaga petechia</i> (syn. <i>Dendroica petechia</i>)	MIS, SSC	Occur along streams or in bushy thickets and willows; sometimes found in montane chaparral; wide ranging.	Could occur.
Olive-sided flycatcher <i>Contopus cooperi</i>	SSC	These flycatchers are mostly associated with edges, openings, and natural and human-created clearings in otherwise relatively dense forests, but they also occupy semi-open forests.	Likely to occur.
Loggerhead shrike <i>Lanius ludovicianus</i>	SSC, BS	Open arid shrublands, woodlands, mountain mahogany, with a few perches/lookouts.	Known to occur.
Northern sagebrush lizard <i>Sceloporus graciosus graciosus</i>	BS	Sagebrush habitats.	Likely to occur.
Lahontan cutthroat trout (LCT) <i>Oncorhynchus clarkii henshawi</i>	T, MIS	Perennial streams and waterbodies on the east side of the northern Sierra Nevada Mountains.	Known to occur.

¹ Status designation:

USFWS ESA

E - Endangered

T - Threatened

Humboldt-Toiyabe National Forest

SS - USFS Region 4 Sensitive Species, Carson District

MIS - USFS Toiyabe Management Indicator Species

SNF - Sierra Nevada Framework Focal Species

BGE - Bald and Golden Eagle Protection Act (USFWS)

Bureau of Land Management

BS - Sensitive Species

State of California: California Endangered Species Act

CT - Threatened

CE - Endangered

California Department of Wildlife

SSC - Species of Special Concern

FP - Fully protected

² Potential for occurrence definitions:

Could occur: Suitable habitat is available in the Project area; however, there are few or no other indicators that the species might be present.

Likely to occur: Habitat conditions, behavior of the species, known occurrences in the Project vicinity, or other factors indicate a relatively high likelihood that the species would occur in the Project area.

Known to occur: The species, or evidence of its presence, was observed in the Project area during surveys or was reported by others.

Source: USFS 2018.

2.4.1 Special Status Wildlife Species Habitat Loss

Table 2-3 details the potential habitat for special status wildlife species that could be altered or lost from Project construction activities. Most surface disturbance from construction activities would be temporary and vegetation communities would be restored as detailed in the Project design features (Section 3.0). When deemed appropriate and applicable, NV Energy will perform



Wildlife Protection Plan

Bordertown to California 120 kV Transmission Line Project COM Plan

pre-construction surveys for northern goshawk and flammulated owl or other USFS sensitive species. Additionally, if construction must occur during the typical avian breeding season (April 1 to July 31), surveys will be conducted prior to construction to location active nesting areas. Section 3.0 provides further details on the Project design features that will be implemented by NV Energy to minimize impacts to special status wildlife species from construction activities.

Table 2-3 Special Status Wildlife Species within the Project ROW/Easement

Species	Vegetation/Habitat	Acres	
		USFS	Private
Northern goshawk, Flammulated owl, White-headed woodpecker, Olive-sided flycatcher	Mixed Conifer, Eastside Pine, and Jeffrey Pine	8.0	2.2
Yellow warbler, Northern goshawk, Flammulated owl, Snowshoe hare, Northern harrier	Willow-Willow Scrub (Riparian)	0.1	1.4
Yellow warbler, Northern goshawk, Flammulated owl, Long-eared owl, Bat species (foraging), Sierra Nevada Snowshoe hare, Northern harrier, Olive-sided flycatcher	Aspen and Riparian Mixed Hardwood	1.1	0.8
Mountain quail, Golden eagle (Mountain sagebrush for foraging), American badger, Loggerhead shrike, Sagebrush lizard	Mountain Mahogany, Snowbrush, Great Basin Mixed Scrub, Bitterbrush, Bitterbrush-Sagebrush, Chaparral, and Mountain Sagebrush	50.7 ¹	18.1
Golden eagle (foraging habitat), American badger, Burrowing owl, Swainson's hawk (w/ large nesting trees)	Big Sagebrush, Low Sagebrush, Annual Grasses, Ruderal, and Urban and Developed	1.7	41.1
Bat species, LCT	Riparian Mixed Hardwood, Wet Meadow Water, and Water	0.0	3.0 ²

¹ Includes approximately 15 acres of Bitterbrush-Sagebrush community on BLM-administered public land at the Bordertown Substation.

² Bull Ranch Creek, Truckee River.

Source: USFS 2018.



3.0 PROTECTIVE MEASURES

Design features for the Project will be implemented by NV Energy and its construction contractor(s) to minimize impacts to wildlife associated with Project construction. The design features listed below guide the implementation of proper avoidance periods and buffer zones during construction by species. The Environmental Field Maps in Volume I provide mapped locations of sensitive resources and identify specific design features such as buffers and boundaries for seasonal closure habitat (detailed below), best management practices, and construction details that correspond to the protection of specific resources.

3.1 CONSTRUCTION PHASE

3.1.1 General Wildlife (General Practices [GP])

- GP 1. All environmentally sensitive areas (i.e., culturally sensitive areas, meadows, and special status plant populations) will be temporarily fenced during construction for avoidance.
- GP 2. Prior to construction, all construction personnel will be instructed on the protection of sensitive biological and cultural resources that have the potential to occur on-site by qualified personnel.
- GP 9. Signs, flagging, or other readily visible markings will be used to indicate the presence of guy wires to reduce the potential for people and wildlife to run into the wires.

Wildlife and Sensitive Wildlife Species (WL) 5. Excavations deep enough to potentially entrap wildlife species will be covered and fenced at night or when unattended to prevent livestock or wildlife from falling in. All covers will be secured in place and strong enough to prevent breakage by wildlife.

Plants and Sensitive Plant Communities (SV) 3. There will be no new access roads or widening of existing roads for construction access through meadows. This measure will also protect potential habitat for special status plant populations that are found in wetland and meadow habitats, such as Dog Valley ivesia (*Ivesia aperta* var. *canina*).

3.1.2 Sensitive Wildlife Species

- WL 1. If any USFS or BLM sensitive wildlife or plant species are identified during pre-construction surveys or during construction activities, work in the general area of the identified species will be halted until a USFS biologist or other qualified biologist is consulted to determine an appropriate buffer and other protective measures. The USFS will be notified within 24 hours of the discovery of the species. Buffer distance will be established in consultation with the USFS on a case by case basis depending on species and type and magnitude of construction activity. If avoidance is infeasible, consultation with the USFS, and at its discretion, any cooperating agencies will be contacted prior to continuing work in the immediate area of the species. The same process will be implemented in the event that



any federal- or state-listed species are discovered on public land, with the discovery being reported to the USFS or BLM, depending on the respective land administration.

3.1.3 Migratory Bird Species

- WL 2. If appropriate, additional surveys for northern goshawk and flammulated owl or other Forest Service sensitive species will be conducted prior to construction by a qualified biologist approved by the USFS. Coordination with the USFS will be conducted prior to commencing surveys to determine appropriate survey methodology, timing, and survey area. If nesting is detected, the USFS will be contacted within 24 hours and Forest Plan standard and guidelines (USFS 2004) will be implemented. A designated Protected Activity Center (PAC) will be delineated around the nest site. Within the PAC no construction activities may occur during the “Limited Operating Period” April 15th-September 30th. Pole construction will need to be designed to span the PAC.
- WL 3. To reduce potential disturbance to migratory birds, construction will occur outside the typical avian breeding season (April 1 to July 31). If construction activities cannot be avoided during this time period, surveys will be conducted immediately prior to construction to locate active nesting areas.
- WL 4. If active avian nests are located on NFS land or BLM-administered public land, they will be flagged and avoided until after the breeding period. NV Energy will coordinate with the USFS or BLM biologist to determine appropriate time frames for resuming construction.

Vegetation (VG) 1. Placement of the ROW will avoid wherever possible, isolated groups of trees and/or groups of trees with an average diameter of dominant and co-dominant trees greater than 24 inches at breast height (dbh) as directed/approved by the USFS Silviculturist.

3.1.4 Raptors

- WL 9. To protect raptors such as hawks and eagles from electrocution, transmission line and pole structures will be constructed in conformance with the guidelines contained in Suggested Practices for Avian Protection on Power Lines: The State of the Art in 2006, prepared by the Avian Power Line Interaction Committee (APLIC) (2006).

3.1.5 Mule Deer

- WL 6. To avoid impacts to wintering mule deer, construction will not occur from November 25 through May 25 within areas mapped as crucial winter or winter-spring high deer use, including the Mitchell Canyon Deer Management Area. Non-ground disturbing activities, such as surveying, staking, or resource driven activities (e.g., cultural surveys, biological surveys), may occur within this time frame.

This Design Feature will not apply to work within fenced and cleared areas associated with the existing California and Bordertown substations, including the Bordertown



Substation expansion area that needs to be cleared and fenced prior to the Limited Operating Period (LOP) of November 25 through May 25, as long as the initial clearing of vegetation occurs outside the LOP. Once the vegetation is cleared and the Bordertown Substation expansion area is fenced, construction of the actual facility will no longer be bound to the LOP restriction.

3.1.6 Lahontan Cutthroat Trout

WL 10. To limit the potential for impacts to aquatic resources, particularly to Lahontan cutthroat trout, pole sites or roads will not be placed within the 100-year floodplain in Dog Creek, Bull Ranch Creek, and the Truckee River. During construction, no soil disturbing activities will occur within the 100-year floodplain of these streams (**Figure 1**).

3.1.7 Avoidance Timeframes

A table of construction timelines restrictions for wildlife specific to the Project are detailed in **Table 3-1**.

Table 3-1 Avoidance Timetable for Wildlife

Species	Activity to Avoid	Avoidance Period	Notes
Mule deer	Construction	November 25 through May 25	See WL. 6
Northern goshawk (occupied nests)	Construction	April 15 through September 30	See WL. 2.
Flammulated owl (occupied nests)	Construction	April 15 through September 30	See WL. 2.
Migratory birds	Construction	April 1 through July 31	See WL. 3.
LCT	Construction	Year-Round	See WL. 10 (Figure 1).

3.1.8 Change Evaluation

NV Energy may request variances from the above restrictions by using the “Change Evaluation” process. Before any variance from the required design features is allowed, the Change Evaluation process described in Chapter 4, Section 4.9.3 of this COM Plan must be completed. The course of action shall be documented and reported to the USFS (the compliance reporting process is also described in Chapter 4). All efforts will be made to not endanger any special status species.

3.2 RECLAMATION PHASE

3.2.1 Habitat Restoration

NV Energy will promote successful restoration of disturbed habitat by requiring restoration success to be based on reference sites selected by the USFS, as described in VG 7 below and as outlined in the Reclamation and Habitat Restoration Plan (Appendix 3C).



VG 7. Successfully restored areas will be defined as:

Reference sites will be pre-established and approved by the USFS. Reference sites will include plant communities that are representative of the ecological site and must include plant communities that are in a late-seral and ecologically functioning condition. Appropriate reference sites will be determined by collecting baseline cover data to indicate plant succession and community structure.

In addition, to encourage the rapid recovery of vegetation communities that benefit species such as mule deer, NV Energy will only cut brush species at ground level to preserve root systems allowing for re-growth (VG-5 below).

VG 5. Where removal of vegetation other than trees is unavoidable, the vegetation will be cut at ground level to preserve the root structure and allow for potential sprouting.

3.2.1.1 Mule Deer Specific Habitat Restoration

WL 7. To aid in providing browse for wintering mule deer, post construction revegetation in areas mapped as crucial winter and winter spring high use habitat will include a seed mix of brush species preferred by mule deer (i.e., bitterbrush, mountain big sagebrush, mountain mahogany, serviceberry (*Amelanchier spp.*), snowberry, and Wyoming big sage) as well as appropriate forbs and grasses.

WL 8. To ensure that impacts to wildlife habitat, particularly mule deer are no more than minor, vegetation that would be permanently lost or temporarily disturbed from the Project, would require creation of or improvement of on or offsite wildlife habitat. To achieve this, NV Energy will fund a habitat restoration account that includes the cost of restoring three acres to every one acre of habitat that is permanently or temporarily disturbed. The account will be administered by NDOW or a Sierra Front Wildlife Working Group that would include NDOW, Washoe County, USFS, BLM, City of Reno and other interested participants.



4.0 REFERENCES

- Avian Power Line Interaction Committee (APLIC). (2006). Suggested Practices for Avian Protection on Power Lines: The State of the Art 2006. Washington, D.C., and Sacramento, California: Edison Electric Institute, Avian Power Line Interaction Committee, and the California Energy Commission.
- Bureau of Land Management (BLM). (2008a). Record of Decision: Eagle Lake Resource Management Plan. Susanville, California: U. S. Department of the Interior, Bureau of Land Management, Eagle Lake Field Office.
- Bureau of Land Management (BLM). (2008b). Manual 6840: Special Status Species Management (Release No. 6-125). U.S. Department of the Interior, Bureau of Land Management.
- Nevada Department of Wildlife (NDOW). (2013). Nevada Wildlife Action Plan. Reno, Nevada: Nevada Department of Wildlife.
- United States Forest Service (USFS). (1986). Toiyabe National Forest Land and Resource Management Plan. U.S. Department of Agriculture, Forest Service, Toiyabe National Forest.
- United States Forest Service (USFS). (2004). Sierra Nevada Forest Plan Amendment, Record of Decision (ROD). Vallejo, California: U.S. Department of Agriculture, Forest Service, Pacific Southwest Region and Intermountain Region.
- United States Forest Service (USFS). (2018). Final Environmental Impact Statement. Bordertown to California 120 kV Transmission Line Project. Humboldt-Toiyabe National Forest, Carson Ranger District Sierra County, California, and Washoe County, Nevada. June 2018.

FIGURE

VA:2037\Active\203703160\03_cad\gib\mxd\Appendix\Figures\Figure_1_LCT_Habitat_Avoidance_Area_11x17.mxd Revised: 2020-05-11 By: chjohnson

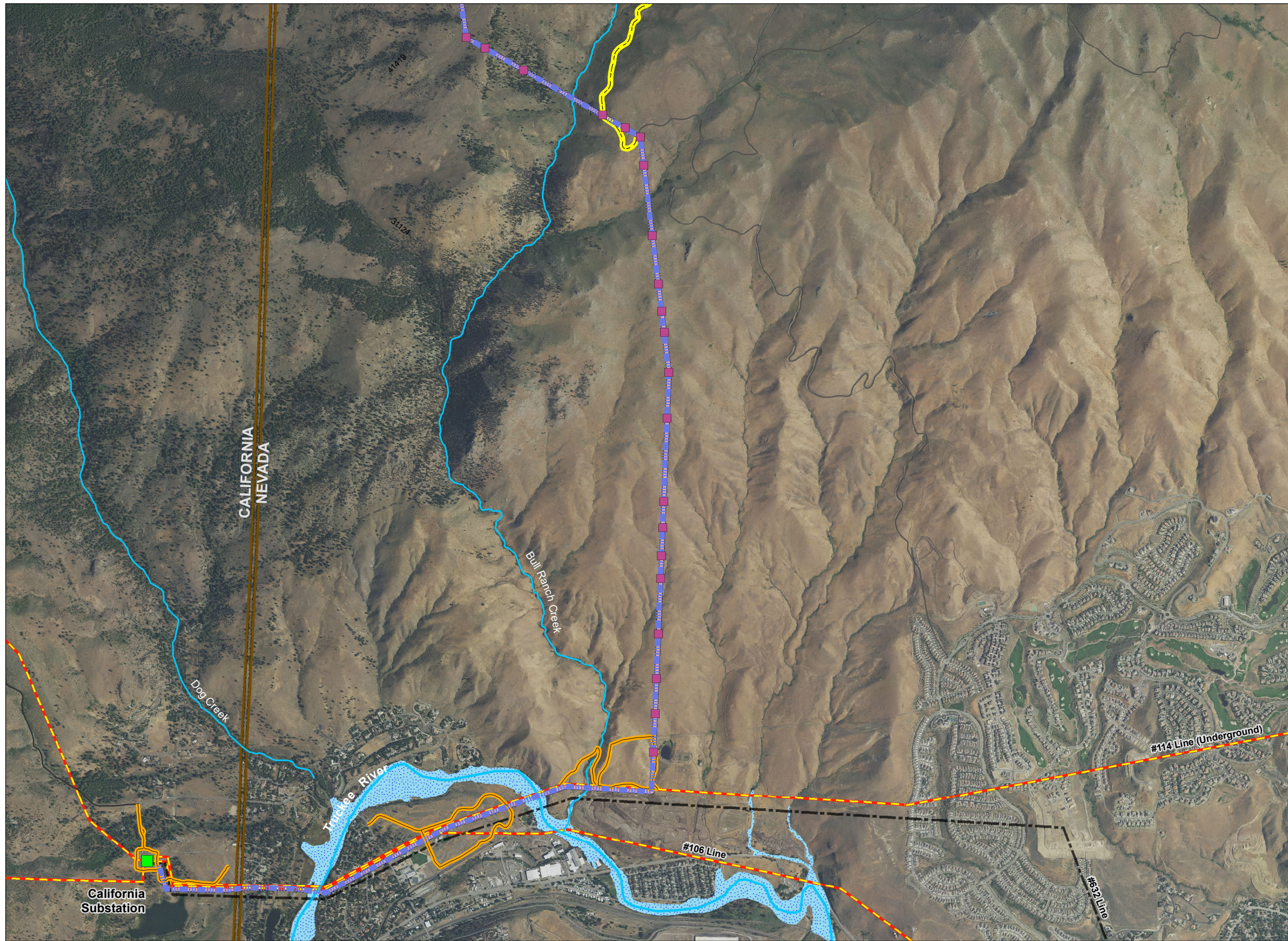

- Legend**
- New Pole Structure
 - Substation
 - ▬▬▬ Bordertown to California 120 kV Transmission Line
 - ▬ Stream
- Existing Features**
- ▬▬▬ 120 kV Transmission Line
 - ▬▬▬ 345 kV Transmission Line
 - ▬▬▬ 60 kV Transmission Line
 - ▬ Public and Private Road
 - ▬▬▬ USFS Roads (Temporary Widening)
 - ▬▬▬ Public and Private Roads across Private Land (Temporary Widening; includes Dirt Roads)
 - ▨▨▨ Flood Plain
 - ▭ State Boundaries

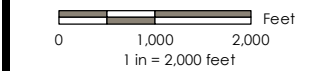

Sierra County, CA & Washoe County, NV
 NAD 1983 UTM Zone 11N

PROJECT NO: 203703160
 DRAWN BY: JT
 1ST REVIEW: CJ
 2ND REVIEW: KC
 DATE: 5/11/2020

NV Energy
 Bordertown to California 120 kV
 Transmission Line Construction,
 Operation, and Maintenance (COM) Plan

Figure 1
LCT Habitat
Avoidance Area

Disclaimer: Stantec assumes no responsibility for data supplied in electronic format. The recipient accepts full responsibility for verifying the accuracy and completeness of the data. The recipient releases Stantec, its officers, employees, consultants and agents, from any and all claims arising in any way from the content or provision of the data.

Service Layer Credits:

APPENDIX C5
Storm Water Pollution Prevention Plans

APPENDIX D1
Inadvertent Discovery Plan

**Inadvertent Discovery Plan
Bordertown to California 120 kV Transmission Line
Construction, Operation, and Maintenance (COM) Plan**

Prepared for:

NV Energy
6100 Neil Road
Reno, Nevada 89511

Prepared by:

Far Western Anthropological Research Group, Inc.
Great Basin Branch
3656 Research Way, Suite 32
Carson City, NV 89706

August 2020

Table of Contents

1.0 INTRODUCTION 1
2.0 DISCOVERY OF CULTURAL RESOURCES 2
3.0 DISCOVERY OF HUMAN REMAINS 4

LIST OF ABBREVIATIONS

COM	Construction, Operations, and Maintenance
kV	Kilovolt
NAGPRA	Native American Graves Protection and Repatriation Act
NRHP	National Register of Historic Places
Plan	Inadvertent Discovery Plan
Project	Bordertown to California 120 Kilovolt Transmission Line Project
SHPO	State Historic Preservation Office
THPO	Tribal Historic Preservation Office
U.S.	United States
USFS	United States Forest Service

1.0 INTRODUCTION

NV Energy and its contractors will construct the Bordertown to California 120 Kilovolt (kV) Transmission Line Project (Project) in compliance with all federal, state, and local regulations as well as the National Environmental Policy Act, the Environmental Impact Statement and Final Record of Decision, the United States (U.S.) Forest Service (USFS) Special Use Permit, and all other applicable permits. The Project area is in Washoe County, Nevada, and Sierra County, California, west and northwest of the city of Reno, Nevada. The northern boundary of the Project area is near Bordertown, Nevada, and U.S. Highway 395 and the southern boundary is near Interstate 80 between Verdi, Nevada, and Mogul, Nevada. The western boundary is roughly parallel with the California state line and the eastern boundary extends to the Peavine area generally east of Peavine Peak. The constructed 120 kV overhead transmission line will be approximately 11.9 miles long and will run between the existing Bordertown and California substations in Sierra County, California.

This Inadvertent Discovery Plan (Plan) is part of NV Energy's compliance obligation and is appended to the Construction, Operations, and Maintenance (COM) Plan. This Plan will be implemented throughout the Project and it details the measures to be taken during construction and operation of the Project should unanticipated buried cultural resources or human remains are identified during Project activities and construction. This Plan details the proper protocols to ensure proper identification, evaluation, and protection of unanticipated cultural resources.

2.0 DISCOVERY OF CULTURAL RESOURCES

The following protocol will be implemented if Project activities or construction discover any cultural resources.

- 1) The Project supervisor or construction contractor(s) will immediately:
 - a. Cease all activity within 100 feet/30 meters of the discovery.
 - b. Notify the USFS Heritage Program Leader, who will notify the applicable State Historic Preservation Office (SHPO), Tribes, Tribes, other consulting parties, and cultural resource consultants assigned to the Project.
 - c. Notify the official Tribal Monitor(s) for each Tribe, if present.
 - d. Leave all artifacts and materials in place but protect the discovery from further damage, theft, or removal.

- 2) The USFS Heritage Program Leader and designated Heritage Specialists will:
 - a. Document the discovery in a manner to support consultation. Documentation should include, but is not limited to, documenting exposed artifacts and features; mapping the extent of artifacts, features, and cultural horizons; and documenting natural and cultural stratigraphy in open trenches or pits.
 - b. Ensure the tribes have been notified and provide the opportunity for tribal representation during documentation of the discovery.
 - c. Evaluate the cultural resources for National Register of Historic Places (NRHP) eligibility. If an eligibility recommendation cannot be made based on the data collected during recordation, additional testing may be required to further delineate the nature, extent, and significance of the discovery. Testing, in consultation with the appropriate SHPO, and Tribes as necessary, will be limited to a sufficient level needed to provide a recommendation of NRHP eligibility.
 - d. If the cultural resources meet NRHP eligibility, the USFS Heritage Program Leader will develop an action plan, mitigation plan, or emergency treatment plan for the affected cultural resources in consultation with the SHPO and Tribes.

- 3) The USFS Heritage Program Leader will:
 - a. Determine NRHP eligibility and consult with the SHPO and Tribes.
 - b. Ensure the USFS follows the Discovery of Human Remains Protocol below, if the discovery contains human remains.
 - c. Ensure the USFS fulfills the requirements of the Native American Graves Protection and Repatriation Act (NAGPRA), as described in the Discovery of Human Remains protocol below, if associated or unassociated funerary objects or objects of cultural patrimony are discovered.
 - d. Recommend the resumption of work if the cultural resources are determined, in consultation with SHPO/THPO, to be ineligible for the NRHP. Resumption will include appropriate monitoring for further cultural resource disturbances.

- e. Consult with the SHPO and consulting parties to avoid, minimize, or mitigate further effects to cultural resources that are determined, in consultation with SHPO, to be eligible for the NRHP. Mitigation efforts may be contingent upon several factors, including the type and extent of the disturbed resource, the extent of the adverse effect, and whether or not it is possible to avoid any further effects to the resource.
- 4) Resumption of work:
- a. Work in the immediate vicinity of the discovered materials may not resume until after the cultural resources are evaluated and adverse effects to historic properties have been avoided, minimized, or mitigated. Resumption of work is the Line Officer's decision. In most cases this will be the USFS District Ranger, but in case where human remains are involved it is recommended that the USFS Supervisor make this decision.

3.0 DISCOVERY OF HUMAN REMAINS

If human remains or remains thought to be human are identified during Project activities and construction, the USFS will ensure that employees or construction contractor(s) comply with federal and state laws. If the discovery is located on federal land, then the federal agency will take the lead on complying with the NAGPRA. If the discovery is located within any other jurisdiction, then state laws will be followed and the respective SHPO will take the lead. State laws include California Health and Safety Code 7050.5, California Public Resources Code 5097.98, and Nevada Revised Statutes 383.150 to 383.190 as amended by Senate Bill 244 in 2017. The following protocol has been developed to assist with compliance in the event of a discovery and is in keeping with federal and state laws:

- 1) The Project supervisor or construction contractor(s) will:
 - a. Ensure that employees or contractors do not take photographs of the human remains out of respect for Tribal concerns and because of law enforcement forensic concerns.
 - b. Be responsible for the security and protection of human remains, funerary artifacts and associated soil during discovery consultations, until disposition of the remains is determined. The area should be cordoned off with fencing or whatever means available.
- 2) The USFS Heritage Program Leader will:
 - a. Notify appropriate law enforcement authorities and/or the County coroner about the human remains and ensure human remains are handled as little as possible by all personnel.
 - b. Fulfill the requirements of federal and state law by consulting with affiliated SHPO, Tribes, and other consulting parties if law enforcement officials determine the human remains are not of recent age or criminal concern.
 - c. Once the discovery is considered not of recent age or criminal concern, Native American human remains will not be handled until an action plan for managing the discovery has been developed.
 - d. Facilitate development of an Action Plan, in consultation with Tribes and SHPO, for managing the discovery.
 - e. Ensure human remains and burials will not be discussed or displayed to the public or media.
 - f. Ensure burial discussions by project personnel are conducted within a professional setting or at the discovery site.
- 3) The USFS Line Officer will:
 - a. Ensure a specialist with expertise in human osteology and human remains make an in-situ assessment of the remains, under the direction of the USFS Heritage

Program Leader, to document the remains and to determine cultural affiliation that would guide the development of a written Action Plan.

- b. Assist the USFS Heritage Program Leader in developing an Action Plan for the evaluation and disposition of the human remains to meet federal and state laws.
 - c. Ensure tribal representatives are afforded the opportunity to conduct rites and ceremonies as deemed appropriate for the discovery.
- 4) Resumption of work:
- a. Work in the immediate vicinity of the human remains may not resume until after the disposition of the human remains is determined and a written binding agreement is executed between the necessary parties in accordance with federal and state law. Resumption of work is the Line Officer's decision. In most cases this will be the USFS District Ranger, but in cases where human remains are involved, it is recommended that the USFS Supervisor make this decision upon the advice of the USFS Heritage Program Leader and law enforcement officers.

APPENDIX E

Permits

(TO BE ADDED WHEN OBTAINED)



FINAL RECORD OF DECISION
BORDERTOWN TO CALIFORNIA
120 KV TRANSMISSION LINE PROJECT
HUMBOLDT-TOIYABE NATIONAL FOREST
WASHOE COUNTY, NEVADA
SIERRA COUNTY, CALIFORNIA

June 2019

**Responsible Official: William A. Dunkelberger, Forest Supervisor
Humboldt-Toiyabe National Forest**

A. Background

In 2011, NV Energy submitted an SF-299 application and preliminary plan of development to the Forest Service (USFS), Humboldt-Toiyabe National Forest requesting a Special Use Permit (SUP) to construct, operate and maintain a 120 kilo-volt (kV) above ground power line that would connect the Bordertown Substation located approximately 18 miles north of Reno, Nevada to the California Substation located near Verdi, Nevada. Both substations are located in Sierra County, California with the majority of the transmission line located in Washoe County, Nevada.

The Forest Service is the lead federal agency completing this EIS in cooperation with the Bureau of Land Management (BLM) Eagle Lake Field Office, Nevada Department of Wildlife (NDOW), Truckee Meadows Regional Planning Agency (TMRPA), Washoe County, Sierra County and the City of Reno. Both the California Public Utilities Commission (CPUC) and the Nevada Public Utilities Commission (PUCN) were invited to participate in the analysis. The CPUC determined that they do not have jurisdiction for this project since NV Energy does not have customers in California and PUCN did not participate because they do not regulate 120 kV transmission lines. The powerline exits each substation within existing utility corridors, located in Sierra County, California. If required, compliance with the California Environmental Quality Act (CEQA) would be completed by Sierra County or Lahontan Quality Control Board following a final record of decision.

Additional authorizations or permits are required where agencies have independent jurisdiction and approval authority over some project segments, including a right-of-way from the BLM for expansion of the Bordertown Substation, and special use permits from the City of Reno, Washoe County, Truckee Meadows Regional Planning Agency and Sierra County. NV Energy will also need to acquire easements across private property.

B. Decision

I have selected the Peavine/Poeville Alternative based upon my review of the analysis disclosed in the Final Environmental Impact Statement (FEIS), project record, and evaluation of the information provided by the applicant. This decision applies only to National Forest System (NFS) land in Washoe County, Nevada. This decision is conditioned on the terms of the special use permit and implementation of project design features, mitigation and monitoring as identified in the Final EIS and in Appendix B, Design Features attached to this Final Record of Decision (ROD). The permit will authorize temporary work areas that are outside of the long-term special use permit area, see (**Figure 2.7-1**).

Beginning at the Bordertown Substation, in Sierra County, California near Bordertown, Nevada the Peavine/Poeville powerline would parallel the existing Alturas 345 kV transmission line for approximately 2.2 miles, with 0.4 miles within the designated Section 368 energy corridor. The powerline would continue south approximately 6.0 miles generally parallel to the California-Nevada State line, approximately 0.6 to 0.9 miles east on the Nevada side of the state line. The last 2.2 miles would be reconstructed within an existing utility easement, replacing the H-frame pole structures of the inactive #632 line, parallel to the existing #114 120 kV and #106 120 kV powerline line west through Verdi, Nevada to the California Substation located in Sierra County, California.

The Peavine/Poeville Selected Alternative would be approximately 11.9 miles long. Approximately 10.8 miles would be constructed in Nevada and 1.1 miles in California. Approximately 4.3 miles or (46.9 acres) would cross NFS land, 0.4 miles or (4.36 acres) would cross BLM land and 7.2 miles or (78.5 acres) would cross private land. The Bordertown Substation would be expanded by approximately 3.7 acres on BLM land. The California Substation would not be expanded, as all needed modifications would be within the existing fenced area of the substation located on private land.

My decision approves the following construction related improvements and restoration activities for the Peavine/Poeville Alternative on NFS land as follows:

Transmission Line: Construction, operation and maintenance of a 120 kV above ground transmission line consisting of poles and electrical wire approximately 4.3 miles in length within a 90-foot wide right-of-way, totaling approximately 46.9 acres. (**Figure 2.7-1**).

Access Roads: Construction, operation, maintenance, widening, and restoration of access roads (**Figure 2.7-1**). These include the following categories of roads identified as:

- Regularly maintained roads: includes construction access and maintenance of Forest Roads 41192 and 41668, but not widened. The total length is approximately 3.8 miles.
- Temporary road or trail widening: these include sections of Forest Roads 41643, 41419, 41669, and motorized trail 21514 to be temporarily widened up to 30 feet to allow for construction access. These routes will be restored to the original road or trail width and revegetated following installation of the transmission line. The total length is approximately 6.7 miles or 17 acres.
- Temporary centerline travel route and work areas: an overland travel route will be utilized for construction access within the variable width corridor and centerline of the 90 foot right-of way. Approximately 127.3 acres containing travel routes and work areas will be revegetated following installation of the powerline.

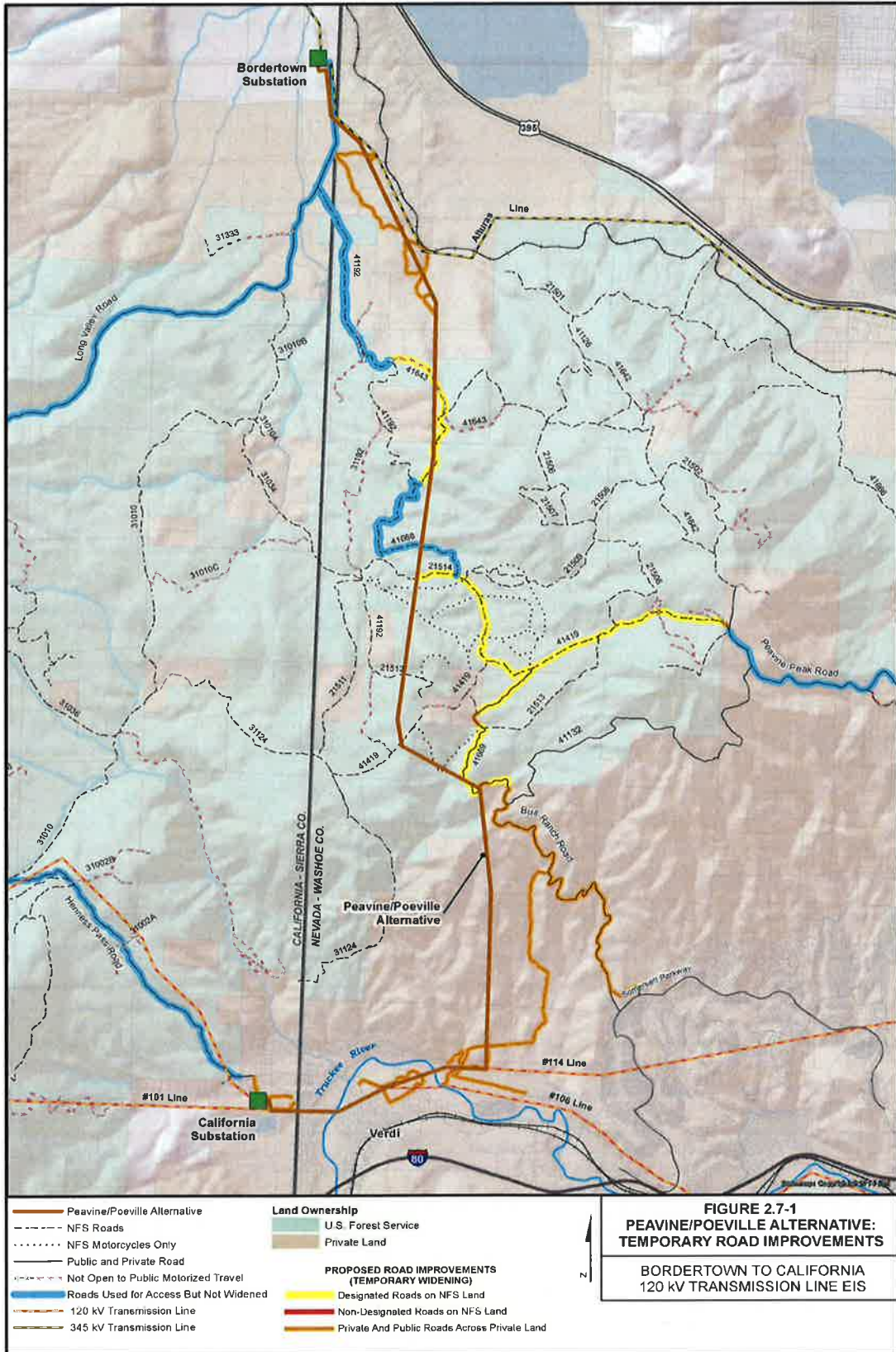

C. Project Design Features and Mitigation Measures

All practicable means to avoid or minimize environmental harm from the alternative selected have been adopted, including a required monitoring plan. Project design features are required to be implemented during construction, operation and maintenance of the powerline and are included in this decision as Appendix B. Mitigation requirements are described below.

D. Required Mitigation

My decision includes mitigation to offset wildlife habitat loss and the development of a historic property treatment plan to mitigate potential adverse effects to cultural resources included as follows:

Wildlife Habitat

To ensure that impacts to wildlife habitat, particularly mule deer are no more than minor, vegetation that would be permanently lost or temporarily disturbed from the project, would require creation of or improvement of on or offsite wildlife habitat. To achieve this, NV Energy will fund a habitat restoration account that includes the cost of restoring three acres to every one acre of habitat that is permanently or temporarily disturbed. The account will be administered by NDOW or a Sierra Front Wildlife Working Group that would include NDOW, Washoe County, USFS, BLM, City of Reno and other interested participants. Appendix B, (WL8).

Cultural Resources

Cultural resources will be managed in accordance with the Memorandum of Agreement among the United States Department of Agriculture, Forest Service, Humboldt-Toiyabe National Forest; the California State Historic Preservation Officer; the Nevada State Historic Preservation Officer; and the Advisory Council on Historic Preservation Regarding the California 120kv Transmission Line By NV Energy on the Humboldt-Toiyabe National Forest, Carson Ranger District, Washoe County, Nevada And Sierra County, California (Bordertown MOA, 2019).

E. Decision Rationale

My decision of the selected alternative provides the needed benefits of reliable electrical transmission capacity to the west side of Reno consistent with the reliability standards that NV Energy is mandated to achieve.

The selected alternative, best meets the purpose and need to provide a back-up power line to serve West Reno within and adjacent to the Humboldt-Toiyabe National Forest in a manner that minimizes crossing NFS land while utilizing regionally and federally designated utility corridors. This alternative minimizes routing across private land, avoids a property listed on the National Register of Historic Places, and avoids designated critical habitat for Webber ivesia (*Ivesia webberi*), a threatened species protected under the Endangered Species Act (ESA). This route maximizes crossing land previously disturbed by wildland fire and minimizes crossing mature forest vegetation types.

My conclusions are based on a review of the FEIS and project record, which documents a thorough analysis of relevant scientific information. I have considered the issues raised by the public during the environmental review. Several of those issues are addressed in the following discussion.

Land Use and Private Property: Land use plans and private property are addressed in Section 3.3.2 of the FEIS. The Peavine/Poeville Alternative crosses 4.3 miles on NFS land, 0.4 miles on BLM land and 7.2 miles on private

land. My selected action will have no impacts to structures from setbacks or separation requirements as the route would cross undeveloped private, NFS and BLM land. The Peavine/Poeville Alternative is consistent with the Toiyabe Land and Resource Management Plan (Forest Plan), BLM Eagle Lake Resource Management Plan (RMP), Sierra County and Truckee Meadows Planning Agency Regional Plan in that it utilizes federal and regionally designated utility corridors. Approximately 4.4 miles of the Peavine/Poeville Alternative would be located within an existing power line corridor consistent with the Truckee Meadows Regional Plan priority hierarchy to “locate new above ground or underground transmission infrastructure in an existing corridor that already contains above ground transmission infrastructure without expanding the corridor width” (Pg. 15 Module 3). The 2012 Sierra County General Plan preference is to locate powerlines that upgrade existing transmission lines and parallel existing transmission lines (Pg. 15-28).

Public Health and Safety: Electric and magnetic fields (EMF) are discussed in Section 3.4 of the FEIS. Presently, there are no federal health-based standards for limiting public exposure to EMFs. Several non- government organizations have recommended science-based exposure limits for EMFs for occupational workers and the general public. The calculated EMFs produced by the Peavine/Poeville Alternative, inside and outside the ROW are below the recommended exposure limits for the general public (FEIS Section 3.4.3.7).

Visual Resources: Visual resources are discussed in Section 3.2 of the FEIS, including Appendix C containing visual simulations. The Peavine/Poeville Alternative will have minimal visual impacts by utilizing the existing utility corridor east of the California Substation by replacing the existing #632 power line in the same location through Verdi see (Key Observation Points 16 and 17) and Section 3.2.4.6 of the FEIS. To further reduce visual effects of powerline transmission poles, design features (VI 1), non-specular conductors will be installed to reduce visual impacts and the number of new poles will be minimized by increasing the pole span length on NFS land in areas designated as Partial Retention as terrain allows (VI 2).

Vegetation Resources: Vegetation resources are discussed in Section 3.7 of the FEIS. The Peavine/Poeville Alternative would minimize crossing mature pine forest communities. Approximately 12 acres of forested habitat will be cleared to maintain safe transmission line clearances (FEIS Section 3.7.2.2).

Special Status Plants: Special status plants are discussed in Section 3.8 of the FEIS. The Peavine/Poeville Alternative avoids impacts to occupied habitat and critical habitat for Webber ivesia (*Ivesia webberi*), a threatened plant species protected under the ESA. Dog Valley ivesia (*Ivesia aperta* var. *canina*), a Forest Service sensitive plant species would also be avoided. Project design features (SV 2), (SV 4 through SV 8), and (HE 11) have been developed to avoid direct effects to special status plant populations and individual plants.

Wildlife Habitat: Wildlife and wildlife habitat is discussed in Section 3.9 of the FEIS. There are temporary and permanent impacts to habitat. The Peavine/Poeville Alternative avoids removal of mature pine forest habitat. The project has been designed to minimize impacts by precluding construction activities from November 25 through May 25 in areas mapped as crucial winter or winter-spring high use areas for mule deer (WL 6) and avoids disturbance to nesting birds by requiring that construction activities occur outside the typical avian breeding season (April 1 to July 31) or requiring surveys to be conducted immediately prior to construction to locate active nesting areas for protection (WL 3). To ensure that impacts to wildlife habitat, particularly mule deer are no more than minor, vegetation that would be permanently lost or temporarily disturbed from the project, would require creation of or improvement of on or offsite wildlife habitat. (WL 8).

Cultural Resources: Cultural resources is discussed in Section 3.5 of the FEIS. The project has been designed to avoid or minimize direct effects to all NRHP listed, eligible or unevaluated sites (CU3) and requires a historic property treatment plan be prepared and implemented where avoidance is not possible. A historic property treatment plan was prepared to mitigate impacts to pre-historic resources (MOA, 2019)

F. Other Required Permits and Approvals

My decision is only one part of the regulatory approvals needed by NV Energy for this project to be approved prior to construction. NV Energy must obtain other agency approvals as described in section 1.9 of the FEIS. The special use permit will not be issued by the Forest Service until NV Energy obtains all applicable permits or licenses.

Alternatives Considered in Detail

In addition to the selected alternative, I considered 4 other alternatives in detail, which are discussed below. A comparison of alternatives considered in detail can be found in Section 2.3 through 2.6 and displayed on Figures 2.1-1 through 2.1-3 in the FEIS. The differences between the action alternatives are the location of the proposed 90-footwide right-of-way and the location of construction access roads, including road widening. The project facilities and substation modifications would be constructed, operated, and maintained under any of the action alternatives. Construction activities, equipment, and materials would apply to all the action alternatives. The number of pole structures and sites, access roads, and transmission wire setup sites required during construction would vary by length and location of each alternative.

No Action Alternative

Under the No Action alternative, the Forest Service would not issue a special use permit. I did not select this alternative because it does not meet to the purpose and need to provide the redundancy needed in NV Energy's power transmission system.

Mitchell Alternative

The Mitchell Alternative would be approximately 11.7 miles long, with 8.4 miles on NFS land. I did not select this alternative because it would impact more forest habitat and would have greater visual effects to private property in Verdi, Nevada and at the Forest Service boundary along Dog Valley/Heness Pass road.

Peavine Alternative

The Peavine Alternative would be approximately 10.3 miles long, with 7.0 acres on NFS land. The first approximately 5.0 miles of the Peavine Alternative would be identical to the Mitchell Alternative. I did not select this alternative because it would impact more forest habitat and would have greater visual effects to private property and at the Forest Service boundary along Dog Valley/Heness Pass road in Verdi, Nevada.

Poeville Alternative

The Poeville Alternative would be approximately 18.0 miles long, with 4.3 miles on NFS land. This alternative had the least number of miles crossing NFS land as any of the other alternatives which is why I originally identified it as the Agency preferred alternative in the Draft EIS. I did not select this alternative because it would have greater impact to private land, greater visual impacts and would potential adversely affect historic properties along the right-of-way including a site listed on the National Historic Register of Historic Places.

G. Alternatives Eliminated from Detailed Study

In addition to the alternatives considered in detail, I also considered 20 additional alternatives. These alternatives were eliminated from further study and analysis as described in the FEIS Section 2.11 as they were either redundant with alternatives considered in detail, were infeasible to construct or would impact occupied habitat for Webber ivesia (*Ivesia webberi*). The proposed action as presented by NV Energy had the potential to impact individual populations and critical habitat of Webber's Ivesia, a plant listed as threatened by the ESA.

H. Public Involvement Conducted

A Notice of Intent (NOI) to prepare an EIS was published in the *Federal Register* on November 21, 2011 (*Federal Register* Volume 76, Number 224). The Bureau of Land Management, Nevada Department of Wildlife, Truckee Meadows Planning Agency, Washoe County, Sierra County, and City of Reno were cooperating agencies in preparation of the EIS. Public notification of the Proposed Action and project documents have been posted on the Humboldt-Toiyabe National Forest Schedule of Proposed Actions website <http://www.fs.usda.gov/goto/htnf/bordertownline>.

A scoping notice describing the project was mailed to residents and interested parties in November 2011 and February 2012. To gain further participation from the public the USFS hosted public meetings in Cold Springs, Nevada, and Verdi, Nevada. In total, 60 people attended the scoping meetings. Presentations were made to the North Valleys Citizen Advisory Board, Verdi Township Citizen Advisory Board, Ward 5 Northwest Neighborhood Advisory Board, Ward 4 North Valleys and Northeast Neighborhood Advisory Board, Reno City Council, Washoe County Commission, and Sierra County Board of Supervisors. Issues raised during scoping included visual resource concerns, wildlife habitat, private property, electromagnetic fields, fire and fuels, recreation, vegetation including noxious weeds and land use.

A Notice of Availability (NOA) for the Draft EIS was published in the *Federal Register* on December 12, 2014 (*Federal Register* Volume 79, Number 239) initiating a 45-day public comment period. Interested and affected individuals were notified by email and regular mail. Public meetings were held at the Northwest Reno Public Library and a presentation at the North Valleys Citizen Advisory Board. Private property was a concern related to the Poeville alternative as it was the longest of the transmission line routes and crossed the most private land.

The Draft Record of Decision (ROD) and Final EIS was noticed in the *Reno Gazette Journal* initiating a 45-day objection period on March 3, 2018. No objections were received.

A letter of support from the Lahontan Regional Water Quality Control Board dated March 14, 2018 included reminders about general construction permitting if required. The water board does not anticipate taking discretionary action for this project as it has been exempted from the California Environmental Quality Act (CEQA). Other permitting requirements are identified in Section 1.9 of the FEIS.

A letter of from the Environmental Protection Agency dated July 19, 2018 supported the management requirements and mitigation measures identified in the FEIS which have all incorporated in Appendix B of this ROD.

A letter from Sierra County dated January 7, 2019 indicated that a permit would not be required for the California Substation improvements. The improvements are within the existing footprint and no discretionary review or approval from the County is needed and is exempt from the California Environmental Quality Act (CEQA).

I. Environmentally Preferred Alternative

As described in the FEIS, Section 2.10, the Environmentally Preferred Alternative is the No Action alternative because it would not result in disturbance to vegetation, soils or wildlife species, individuals or habitat. There would be no tree removal. There would be no road widening or restoration efforts needed to restore vegetation following construction. There would be no risk of new noxious weed establishment and no effects to habitat supporting pollinators for sensitive plant species. There would be no effects to cultural resources. I did not select this alternative because it would not meet the purpose and need of the project to provide reliable bulk transmission capacity to the West Reno/Verdi area.

J. Tribal Consultation

During the early planning stages of this analysis (2011), the Forest Service conducted informal consultation with the Reno-Sparks Indian Colony, the Washoe Tribe of Nevada and California, and the Pyramid Lake Paiute Tribe to discuss the project and potential effects to cultural resources. Intensive tribal consultation continued throughout the analysis and development of the Bordertown MOA (2019). Consultation will continue throughout implementation of the project.

K. Findings Required by Other Laws and Regulations

The National Forest Management Act (NFMA) requires projects and permits to be consistent with the Land Management Plan (16 USC § 1604(i)). Consistency with the Forest Plan is discussed in Section 3.3.2 of the FEIS. This decision to select the Peavine-Poeville Alternative is consistent with the Humboldt-Toiyabe Land and Resource Management Plan (Forest Plan) long term and multiple use goals and objectives listed in Chapter IV, Pages 1-12. The project was designed in conformance with forest plan standards and incorporates appropriate Forest Plan guidelines for managing sensitivity and visual quality objectives (IV-3), engaging the public in the decision making process (IV-5), protecting soils from being degraded and maintaining water quality (IV6), maintaining forested habitats for nongame and ecologically important species (IV-7), protection of sensitive and threatened species and coordination with State Wildlife Agencies (IV-7), National Register properties will be protected and noxious weed infestations will be treated (IV-12).

This decision also conforms to the following laws, regulations, policy, and executive orders.

LAW, REGULATION, POLICY, OR EXECUTIVE ORDER	STATEMENT OF CONFORMANCE
American Antiquities Act of 1906 (as amended)	Design features (Appendix B) have been developed to prohibit the collection or disturbance of archeological sites encountered during construction. All prior cultural resource surveys and any potential future cultural resource surveys for the proposed project were conducted by qualified archaeologists under a permit issued by the USFS.
American Indian Religious Freedom Act of 1978	Native American Tribes were consulted to determine the presence of American Indian religious sites. See tribal consultation summary (Section 4.2.2 FEIS).
Archeological Resource Protection Act of 1979	Design features (Appendix B, FEIS) have been developed to prohibit the unauthorized collection or disturbance of archeological sites encountered during construction or maintenance of the project.
Bald and Golden Eagle Protection Act of 1940 (as amended)	The proposed project would not result in the “take” of bald eagles or golden eagles. The project would be in conformance with the Bald and Golden Eagle Protection Act of 1940, as amended.
BLM Manual 6500: Wildlife and Fisheries Management (1988)	Design features (Appendix B) have been incorporated into the proposed project to avoid or minimize impacts to wildlife and fisheries as much as feasible.
BLM Manual 6840: Special Status Species Management (2008a)	Design features (Appendix B) have been incorporated into the proposed project to avoid or minimize impacts on BLM special status species.

LAW, REGULATION, POLICY, OR EXECUTIVE ORDER	STATEMENT OF CONFORMANCE
Clean Air Act of 1979 (as amended)	The proposed project would be compliant with the CAA of 1979, as amended, because emissions of criteria pollutants would be below the NAAQS (see Section 3.12 FEIS). Other air pollution problems addressed in the CAA, such as acid rain or depletion of the ozone layer are not relevant to the proposed project.
Clean Water Act of 1977 (as amended)	The discharge of pollutants from a point source would not occur under the proposed project. All impacts to waters of the United States would be permitted under Section 404 of the CWA.
Endangered Species Act of 1973 (as amended)	The proposed project would not jeopardize the continued existence of any listed species or result in the destruction or adverse modification of designated critical habitat of such species. The proposed project would not result in the “take” of any listed species or species proposed for listing. See agency consultation summary (Section 4.2.1 FEIS).
Executive Order 11988 (floodplains)	The proposed project would not require occupancy within the 100-year floodplain. The proposed project would not modify the flood flow retention capability of the 100-year floodplain (see Section 3.6.2.2 FEIS).
Executive Order 11990 (wetlands)	Compliant with Executive Order 11990, design features (Appendix B) have been developed to minimize impacts to wetlands on NFS land and BLM-administered public land.
Executive Order 12898 (environmental justice)	Compliant with Executive Order 12898, the USFS has completed an environmental justice analysis. A summary of the analysis conclusions is provided in Section 3.1.1.2.
Executive Order 13007 (American Indian sacred sites)	Native American Tribes were consulted to determine the presence of American Indian sacred sites. See tribal consultation summary (Section 4.2.2).
Executive Order 13175 (consultation and coordination with Indian Tribal Governments)	Consultation with Native American Tribes was conducted in accordance with Executive Order 13175. See tribal consultation summary (Section 4.2.2).
Executive Order 13186 (Migratory Bird Treaty)	Pursuant to Executive Order 13186, the potential effects of the proposed project on migratory birds are evaluated in Section 3.9. Design features (Appendix B) have been developed to avoid impacting nesting migratory birds during construction.
Federal Land Policy Management Act of 1976	In accordance with the Federal Land Policy Management Act of 1976, this EIS evaluates the proposed project in terms of its conformity with the Eagle Lake RMP (BLM 2008b) and its potential effects on the various resources contributing to the multiple uses for which the BLM-administered public land in the project area is managed.
Historic Sites Act of 1935	The potential effects of the proposed project on historic properties listed on the NRHP or eligible for such listing have been evaluated. See SHPO consultation summary (Section 4.2.3 FEIS).

LAW, REGULATION, POLICY, OR EXECUTIVE ORDER	STATEMENT OF CONFORMANCE
Memorandum of Understanding to Promote the Conservation of Migratory Birds (BLM and USFWS 2010)	Pursuant to the Memorandum of Understanding to Promote the Conservation of Migratory Birds (BLM and USFWS 2010), the potential effects of the proposed project on migratory birds are evaluated in Section 3.9. Design features (Appendix B) have been developed to avoid impacting nesting migratory birds during construction.
Migratory Bird Treaty Act of 1918 (as amended)	Design features (Appendix B) have been incorporated into the proposed project requiring pre-disturbance migratory bird nesting surveys if surface disturbance is unavoidable during the migratory bird nesting season. The proposed project would not result in the “take” of migratory birds, their eggs, or their nests.
National Bald Eagle Management Guidelines (USFWS 2007)	The proposed project would not result in the “take” of bald eagles or impact bald eagles. The proposed project would be in conformance with the guidelines. (Section 3.10.2 FEIS)
National Forest Management Act of 1976	In accordance with the National Forest Management Act of 1976, this EIS evaluates the proposed project in terms of its conformity with the Forest Plan (USFS 1986) and its potential effects on the various resources contributing to the multiple uses for which the NFS land in the project area is managed. (Section 3.3.2.1 FEIS)
National Historic Preservation Act of 1966 (as amended)	In accordance with Section 106 of the NHPA, the potential effects of the proposed project on historic properties listed on the NRHP or eligible for such listing were evaluated prior to signing the ROD. See agency consultation summary (Section 4.2.3). The Forest Service prepared the Bordertown MOA pursuant to the NHPA.
Native American Graves Protection and Repatriation Act of 1990	In the event that Native American human remains or grave goods are encountered during construction, personnel will follow the Inadvertent Discovery Plan in Appendix C of the Bordertown MOA (2019). Native American Tribes would be consulted in the event that Native American human remains are encountered.

L. Implementation Date

This Final ROD can signed as the following requirements have been met:

1. Objections. No objections were received during the 45-day formal objection period initiated by the legal notice in the Reno Gazette Journal on March 9, 2018.
2. Thirty days following the publication of the notice of availability (NOA) for the Final EIS in the federal register (40 CFR 1506.10). The Notice of Availability of a Final EIS was published in the Federal Register on June 22, 2018.
3. Section 106 of the National Historic Preservation Act compliance. The Bordertown MOA was signed May 10, 2019. A letter dated May 24, 2019 from the Advisory Council on Historic Preservation provided the fully executed agreement.

This project will be authorized by a Forest Service special use permit when:

1. NV Energy obtains all applicable permits and approvals including but not limited to special use permits from the BLM, Truckee Meadows Planning Agency, Washoe County, City of Reno, and private easements, see Section 1.9 of the FEIS. The project will be phased with improvements beginning at the California substation on private land and Bordertown Substation on Bureau of Land Management to occur in 2020 with powerline construction anticipated in 2021.
2. The wildlife habitat restoration account is funded with the Nevada Department of Wildlife.
3. The construction, operation, maintenance plan is approved by the Forest Service.

M. Contact Person

For additional information concerning this final record of decision contact Marnie Bonesteel, Lands Special Uses Program Manager, Humboldt-Toiyabe National Forest, at (775) 352-1240, or marnie.bonesteel@usda.gov



William A. Dunkelberger, Forest Supervisor
Humboldt-Toiyabe National Forest



Date

Appendix B Project Design Features

General Practices (GP)

- GP 1. All environmentally sensitive areas (i.e., culturally sensitive areas, meadows, and special status plant populations) will be temporarily fenced during construction for avoidance.
- GP 2. Prior to construction, all construction personnel will be instructed on the protection of sensitive biological and cultural resources that have the potential to occur on-site by qualified personnel.
- GP 3. Construction activities may require temporary access through existing fences and gates on public and private land. Fencing will be replaced when construction activities are completed. Replacement fencing will be built to agency or landowner specifications, consistent with the fencing that was removed. During construction, fences with open gates will remain open and fences with closed gates will remain closed. Fences crossed during construction will be braced and secured prior to cutting the fence to prevent slackening of the wire.
- GP 4. Prior to any construction activities, all utilities will be located by utilizing “Call before you dig” to avoid disruption to any services. If blasting is required within proximity to the Kinder Morgan buried gas pipeline, NV Energy will coordinate with Kinder Morgan and use a qualified licensed blaster.
- GP 5. Concrete wash out stations will be pre-approved and the water will be captured and disposed off NFS Lands and at an approved facility.
- GP 6. Long-term equipment staging and storage areas will not be located on NFS land.
- GP 7. Near sensitive receptors (i.e., occupied residences), noise-generating activities (e.g., blasting) will be limited to Monday through Friday from 7:00 a.m. to 7:00 p.m. Otherwise, work may occur 12 hours per day any day of the week.
- GP 8. Annual inspection will be made via helicopter or from the ground by walking to pole structures from existing roads.
- GP 9. Signs, flagging, or other readily visible markings will be used to indicate the presence of guy wires to reduce the potential for people and wildlife to run into the wires.

Noxious Weeds (NW)

- NW 1. Noxious weeds occurring on either the Nevada or California State list will be mapped and the full extent of the population will be treated prior to and following construction. Inventory and treatment areas will extend 100 feet from the ROW and all ground disturbed by project activities. Project disturbances include roads proposed for widening, construction access roads, equipment and material staging areas, and vegetation removal, including skid trails and landings.
- NW 2. Monitoring and continued treatment in areas that were treated prior to construction will commence the first full growing season after project implementation. Weed treatment will continue until disturbed areas are successfully restored (see restoration criteria). Weed treatment will continue during maintenance activities and within the ROW.
- NW 3. All equipment utilized off of existing roads and motorized trails will be cleaned with a high-pressure power washer of all mud, dirt, and plant parts. Following cleaning, equipment will be inspected for plant parts (e.g., leaves, stems, seeds). Equipment will be cleaned and inspected again prior to re-entry if it leaves the project site. Equipment will be inspected and cleaned again before moving from an area within the project area with known noxious weed species.

Inspections will be completed and documented by qualified personnel such as a USFS noxious weed specialist or USFS botanist.

- NW 4. When cut and fill is required to create log landings, topsoil will be stockpiled and covered to prevent weeds from establishing in the soil. This topsoil will be re-spread during restoration of the landings.
- NW 5. Staging areas will not be located in weed infested areas. Staging areas will be inspected by qualified personnel for pre-approved use to reduce the risk of introducing noxious weeds into the project area.
- NW 6. Construction of access roads will not occur in areas heavily infested with noxious or invasive weeds.
- NW 7. Restoration seed mixes will be certified as weed-free.
- NW 8. All gravel and/or fill material will be certified as weed-free.
- NW 9. NV Energy will coordinate with other county, state and federal agencies to address and treat landscape level infestations of invasive plant species.
- NW 10. For invasive plants that can be effectively controlled through grubbing or manual removal, methods that prevent seed spread or re-sprouting will be used. If flowers or seeds are present, the weed will be pulled carefully to prevent seeds from falling and will be placed in an appropriate container for disposal. If flowers and seedheads are not present or are removed and disposed of as described above, the invasive plant may be pulled and placed on the ground to dry out.
- NW 11. The appropriate method of control specific to the type of noxious weed will be used. Specific methods will be identified in the COM Plan.

Vegetation (VG)

- VG 1. Placement of the ROW will avoid wherever possible, isolated groups of trees and/or groups of trees with an average diameter of dominant and co-dominant trees greater than 24 inches at breast height (dbh) as directed/approved by a USFS Forester.
- VG 2. All trees measuring 8 inches or greater in dbh that need to be removed shall be identified and marked for removal by a USFS Forester prior to felling on NFS land.
- VG 3. For trees measuring 8 inches or greater in dbh, stump height shall not exceed 12 inches above ground level on the uphill side or 12 inches above natural obstacles. Trees less than 8 inches in dbh, stump heights shall not exceed 6 inches above ground level on the uphill side or 6 inches above natural obstacles.
- VG 4. Trees identified for removal will be whole tree yarded to log landings for disposal. Permits and/or contracts shall be issued prior to felling any trees greater than 8 inches dbh. All logs and slash will be removed from NFS land within 6 weeks to reduce insect and disease infestations. Woodchips not needed for restoration will also be removed from NFS land within 6 weeks.
- VG 5. Where removal of vegetation other than trees is unavoidable, the vegetation will be cut at ground level to preserve the root structure and allow for potential sprouting.
- VG 6. All areas of temporary ground disturbance that result from the construction or maintenance of the project will be restored as required by the land management agency and per any applicable permits. Restoration will include restoring contours to their approximate pre-construction condition, stabilizing the area through seeding, mulching, placement of erosion control fabric, and installing erosion control features. Revegetation may include incorporation of chips into the

soil, as needed. Erosion control includes installing cross drains and placing water bars in the road, as needed.

- VG 7. Successfully restored areas will be defined as:
Reference sites will be pre-established and approved by the USFS. Reference sites will include plant communities that are representative of the ecological site and must include plant communities that are in a late-seral and ecologically functioning condition. Appropriate reference sites will be determined by collecting baseline cover data to indicate plant succession and community structure.
- VG 8. Project implementation will comply with conditions in Lahontan Water Quality Control Board timber harvest waiver.

Herbicide Use (HE)

- HE 1. Herbicides will be used in accordance with label instructions, except where project design features describe more restrictive measures. An herbicide use plan will be developed and included in the COM Plan.
- HE 2. Prior to the start of application, all spray equipment will be calibrated to insure accuracy of the delivered amounts of herbicide. Equipment used during herbicide application will be regularly inspected to insure it is in proper working order.
- HE 3. Herbicide spray applications will not occur when wind velocity is 5 miles per hour or greater to further minimize the potential for drift.
- HE 4. Herbicide applications will not be conducted during rain or immediately following rain when soil is saturated or runoff or standing water is present. Application will occur only under favorable weather conditions, defined as:
- a) 30% or less chance of precipitation on the day of application based upon National Weather Service weather forecasting for the Reno area;
 - b) If rain, showers or light rains are predicted within 48 hours, the amount of rain predicted shall be no more than ¼ inch of rain; and
 - c) Rain does not appear likely at the time of application.
- HE 5. Preparation of herbicides for application, including mixing, filling of wands and rinsing of spray equipment, will take place outside of wetlands, meadows, riparian zones, wells and springs, and other sensitive sites, and more than 300 feet from surface water. Herbicide preparation will occur only on level, disturbed sites such as the interior of landings.
- HE 6. A spill cleanup kit will be readily available whenever herbicides are transported or stored. A spill kit will be carried by the applicator at all times when using the wicking application method.
- HE 7. Low nozzle pressure (<25 pounds per square inch), and a coarse spray (producing a median droplet diameter of >500 microns) will be used in order to minimize drift during herbicide applications.
- HE 8. Prior to treatments in areas of concentrated public use, the public will be notified about upcoming herbicide treatments via posting signs.
- HE 9. The herbicide spray nozzle will be kept as close to target plants as possible (within 20 inches) while achieving uniform coverage in order to limit overspray and drift to non-target vegetation.

- HE 10. Where riparian vegetation communities occur, herbicide application will be limited to directed foliar spray or wiping methods and spray will be directed away from native vegetation.
- HE 11. Herbicide treatments will not occur within 500 feet of sensitive plant occurrences.
- HE 12. Herbicide application within wet meadows will be limited to treating invasive plant infestations that occupy less than 100 square feet. Herbicide applications will be limited to wiping techniques with aminopyralid, chlorsulfuron, and glyphosate and treatment of the following high priority species: Canada thistle (*Cirsium arvense*), yellow star thistle (*Centaurea solstitialis*), Russian knapweed (*Acroptilon repens*) or tall whitetop (*Lepidium latifolium*) which are difficult to eradicate with non-chemical means. Meadows will be surveyed for special status plant species prior to any chemical treatments and will be monitored post-treatment to determine effects to non-targeted vegetation.
- HE 13. Herbicide application will not occur within the established buffers for aquatic features shown in **Table B-1**.

Table B-1 Minimum Buffers (ft) for Herbicide Application Near Aquatic Features

Herbicide	Application Method	Dry Aquatic Features	Streams ¹ or Ditches with Water ²	Wetland or Meadow
Aminopyralid	Spot & directed foliar spray	25	25	100
	Wiping	15	150	15
Chlorsulfuron	Directed foliar spray	25	100	100
	Wiping	15	15	15
Glyphosate	Directed foliar spray or drizzle	0	25	25
	Cut stump or wiping	0	15	15
Imazapic	Directed foliar spray	25	75	75
Triclopyr (TEA)	Directed foliar spray	25	75	75
	Wiping or cut stump	15	15	15
Clopyralid	Spot & directed foliar spray	25	50	50
	Wiping	15	15	15

¹As measured from the edge of the stream channel. If a defined channel is not present (draws do not have defined channels), measurement is from the bottom of the feature.

²As measured from the edge of the wet area or the meadow vegetation, whichever is greater. Limited conditions allowing for herbicide application within meadows are described in HE 17.

- HE 14. Herbicide application is limited to targeted treatments directed at the plant (spot treatments of the immediate area surrounding the plant are allowed with aminopyralid and clopyralid, only) using a backpack sprayer; broadcast spray methods that dispense chemical over a non-localized area will not be used.
- HE 15. Avoid application of Aminopyralid and Clopyralid sprayed mulch materials on revegetation sites.

Forest Health (FH) - Insects and Disease

- FH 1. To reduce the build-up or residual tree mortality by pine engraver beetles (*Ips pini*), and reduce fuel loading the following measures shall occur:
- a. Trees greater than 3 inches diameter at breast height (dbh) (whether in accessible or inaccessible areas) shall be removed (after proper permitting) to established log landings. Slash shall be chipped and hauled off of NFS land for disposal. All logs and slash shall be removed from NFS lands within 6 weeks of cutting. Any incidental breakage during whole-tree yarding that is 3 inches in diameter or greater shall be lopped and scattered to within 18 inches of the ground in open areas.
 - b. Timing: In areas where material 3 inches or greater in diameter is left on site, cutting shall only occur from August 1 through December 31. Material must be lopped and scattered to within 18 inches of the ground in open areas. There are no timing restrictions for dead trees or species other than pine.

Water Resources and Soil (WA)

- WA 1. As a part of the COM Plan, SWPPP will be prepared to minimize erosion from the project construction worksites and to contain sediment. The SWPPP will be prepared in accordance with the National Pollutant Discharge Elimination System (NPDES) General Construction Stormwater Permit. At a minimum, it will identify the existing drainage patterns of the construction work sites and ROW/easement, nearby drainages and washes, potential pollutant sources other than sediment, and erosion and sediment control measures and BMPs that will be implemented to protect stormwater runoff. The SWPPP will include maps with locations for erosion and sediment control measures, and BMPs. The SWPPP will be kept on site throughout the duration of construction.
- WA 2. Erosion and stormwater controls will be inspected on the ground at least once every seven days and within 24 hours of a storm event of 0.5 inch or greater. Weather forecasts and data available from the National Weather Service in Reno will be used to determine total precipitation associated with a storm event. Qualified personnel of NV Energy or its contractors with specific training in erosion and sediment control will perform the inspections.
- WA 3. Construction equipment staging areas, and storage of equipment fuels will not be located within 300 feet of perennial streams or within 150 feet of intermittent and ephemeral streams. Staging areas and fuel storage will also not be located within 150 feet of wetlands or other water feature.
- WA 4. Pole sites and staging areas will not be constructed within the 100-year floodplain of any stream or within wetlands.
- WA 5. Construction equipment will not be operated on unstable soils or on soils too wet to adequately support equipment in order to prevent rutting, puddles on soil surface, or runoff of sediments directly into water bodies.
- WA 6. Topsoil removed from foundation holes will be separated and stockpiled at the edge of active work areas to salvage the seed bank.
- WA 7. Water drafting (i.e. water withdrawal) from streams will not be permitted. Water shall be provided by truck for dust abatement and other project needs.

Temporary Stream Crossings

- WA 8. Improvements to any existing road crossing will be designed to minimize surface disturbance.

- WA 9. Crossings will be located where the stream channel is narrow, straight, and uniform, and has stable soils and relatively flat terrain. Stream crossings will be oriented perpendicular to the stream channel. All stream crossings will be designed and installed such that sufficient load-bearing strength for the expected equipment is provided.
- WA 10. Stream crossings will be designed for a normal range of flows for the site, and crossings that must remain in place during high runoff seasons will be stabilized. However, all crossings will be temporary and will be removed at the end of the construction season. The water body profile and substrate will be restored when the crossing is removed.
- WA 11. Stream crossings will be regularly monitored to evaluate the condition. Any repairs or improvements to the crossings identified during monitoring will be promptly addressed.
- WA 12. Surface drainage and roadway stabilization measures will be used to disconnect the access road from the stream in order to avoid or minimize water and sediment from being channeled into surface waters and to dissipate concentrated flows.
- WA 13. On perennial streams, existing crossings will be utilized and no new crossings will be constructed.

Plants and Sensitive Plant Communities (SV)

- SV 1. If any Forest Service or BLM sensitive plant or federal- or state-listed species are identified during construction activities, the USFS will be contacted within 24 hours. Depending on the plant species appropriate protective measures will be implemented.
- SV 2. Prior to construction, once access roads and pole locations are known, the following tasks will be completed for areas where surface disturbance is planned:
 - a. Pre-construction surveys for jaw-leaf lupine, andesite popcorn flower, and moonwort ferns;
 - b. Mapping and flagging of sensitive plant species, wetland areas, and noxious weeds; and
 - c. Noxious weed infestations will be treated according to design features NW1 and NW 2.
- SV 3. There will be no new access roads or widening of existing roads for construction access through meadows. This measure will also protect potential habitat for special status plant populations that are found in wetland and meadow habitats, such as Dog Valley ivesia.
- SV 4. Poles, staging areas, and line clearance areas, and any project-related ground disturbance will avoid all special status plant populations.
- SV 5. Where existing roads are used for travel to the project site (but not widened), any road maintenance within 100 feet from special status plant populations will focus on avoiding impacts. A permanent physical barrier, such as lining the roads with rock or fencing the road corridor, will be constructed to prohibit vehicle access to sensitive plant populations and contain travel within the existing road corridor.

Webber Ivesia and Dog Valley Ivesia

- SV 6. Construction of new access roads (i.e., spur roads and centerline travel roads) and widening of existing roads and motorized trails will not occur within 500 meters (1,640 feet) of populations of Dog Valley ivesia (*Ivesia aperta* var. *canina*) and Webber ivesia (*Ivesia webberi*) occurring on NFS land. Allowable maintenance of roads within these habitat areas that do not require widening include blading and installation of erosion control measures. Construction of new temporary access roads and widening of existing roads and motorized trails will not occur within 200 feet of other special status plant populations that occur on NFS land. Within these buffer

distances, travel and road maintenance on existing roads and motorized trails may be permitted but road improvements including widening of the existing travelled way are prohibited.

- SV 7. The transmission line will be excluded from the occupied habitat unit for Webber ivesia populations occurring on NFS land. (Occupied habitat includes the low sage habitat where the plants are present and a 500-meter buffer from the edge of the occurrence. The 500-meter buffer would include low sage and adjacent shrub steppe habitats to accommodate pollinators associated with the rare plant community).
- SV 8. Techniques to span over Webber ivesia potential habitat (i.e., unoccupied suitable habitat) will be evaluated with a USFS botanist. Unavoidable pole placement within habitat will require use of a helicopter. Access roads will not be constructed within potential habitat. Potential habitat includes low sage plant communities with specific habitat attributes: presence of a rocky pavement surface, presence of an argillic soil horizon, plant community composition and presence of associated plants, topographic position of the site, and, known elevation range. Areas defined as potential habitat will require the 500-meter buffer.

Wildlife and Sensitive Wildlife Species (WL)

- WL 1. If any Forest Service or BLM sensitive wildlife or plant species are identified during pre-construction surveys or during construction activities, work in the general area of the identified species will be halted until a USFS biologist or other qualified biologist is consulted to determine an appropriate buffer and other protective measures. The USFS will be notified within 24 hours of the discovery of the species. Buffer distance will be established in consultation with the USFS on a case by case basis depending on species and type and magnitude of construction activity. If avoidance is infeasible, consultation with the USFS, and at its discretion, any cooperating agencies will be contacted prior to continuing work in the immediate area of the species. The same process will be implemented in the event that any federal- or state-listed species are discovered on public land, with the discovery being reported to the USFS or BLM, depending on the respective land administration.
- WL 2. If appropriate, additional surveys for Northern goshawk and flammulated owl or other Forest Service sensitive species will be conducted prior to construction by a qualified biologist approved by the USFS. Coordination with the USFS will be conducted prior to commencing surveys to determine appropriate survey methodology, timing, and survey area. If nesting is detected the Forest Service will be contacted within 24 hours and Forest Plan standard and guidelines (USFS 2004) will be implemented. A designated Protected Activity Center (PAC) will be delineated around the nest site. Within the PAC no construction activities may occur during the "Limited Operating Period" April 15th- September 30th. Pole construction will need to be designed to span the PAC.
- WL 3. To reduce potential disturbance to migratory birds, construction will occur outside the typical avian breeding season (April 1 to July 31). If construction activities cannot be avoided during this time period, surveys will be conducted immediately prior to construction to locate active nesting areas.
- WL 4. If active avian nests are located on NFS land or BLM-administered public land, they will be flagged and avoided until after the breeding period. NV Energy will coordinate with the USFS or BLM biologist to determine appropriate time frames for resuming construction.
- WL 5. Excavations deep enough to potentially entrap wildlife species will be covered and fenced at night or when unattended to prevent livestock or wildlife from falling in. All covers will be secured in place and strong enough to prevent breakage by wildlife.

- WL 6. To avoid impacts to wintering mule deer, construction will not occur from November 25 through May 25 within areas mapped as crucial winter or winter-spring high deer use, including the Mitchell Canyon Deer Management Area. Non-ground disturbing activities, such as surveying, staking, or resource driven activities (e.g., cultural surveys, biological surveys), may occur within this time frame.
- WL 7. To aid in providing browse for wintering mule deer, post construction revegetation in areas mapped as crucial winter and winter spring high use habitat will include seed mix of brush species preferred by mule deer (i.e., bitterbrush, mountain big sagebrush, mountain mahogany, serviceberry, snowberry, and Wyoming big sage) as well as appropriate forbs and grasses.
- WL 8. To ensure that impacts to wildlife habitat, particularly mule deer are no more than minor, vegetation that would be permanently lost or temporarily disturbed from the project, would require creation of or improvement of on or offsite wildlife habitat. To achieve this, NV Energy will fund a habitat restoration account that includes the cost of restoring three acres to every one acre of habitat that is permanently or temporarily disturbed. The account will be administered by NDOW or a Sierra Front Wildlife Working Group that would include NDOW, Washoe County, USFS, BLM, City of Reno and other interested participants.
- WL 9. To protect raptors such as hawks and eagles from electrocution, transmission line and pole structures will be constructed in conformance with the guidelines contained in Suggested Practices for Avian Protection on Power Lines: the State of the Art in 2006, prepared by the Avian Power Line Interaction Committee (2006).
- WL 10. To limit the potential for impacts to aquatic resources, particularly to Lahontan cutthroat trout, pole sites or roads will not be placed within the 100-year floodplain in Dog Creek, Bull Ranch Creek, and the Truckee River. During construction, no soil disturbing activities will occur within the 100-year floodplain of these streams.

Cultural Resources (CU)

- CU 1. All personnel working on the project should be familiar with, and be in possession of, the Bordertown Inadvertent Discover Plan (Appendix C of the Bordtown MOA).
- CU 2. If previously unidentified cultural resources are found, work will be halted immediately within a minimum distance of 300 feet from the discovery. Personnel must adhere to Bordertown Inadvertent Discovery Plan (Appendix C of the Bordertown MOA).
- CU 3. In the event the project changes during implementation, the Forest Service will reinstate consultation per regulations at 36 CFR 800 and in compliance with Section 106 of the National Historic Preservation Act.
- CU 4. Archaeological monitors are required per the Bordertown MOA (2019). They will assess avoidance measures and monitor disturbance activities near culturally sensitive areas.
- CU 5. If human remains are encountered during construction activities, all work within 300 feet of the remains will halt and the requirements of personnel identified in the Bordertown Inadvertent Discovery Plan will be followed.
- CU 6. Per the Bordertown Inadvertent Discovery Plan, if the remains are Native American, USFS will follow the procedures set forth in 43 CFR 10, Native American Graves Protection and Repatriation Regulations and notify the appropriate Native American Tribe(s) immediately. If the Native American human remains are located on state or private land, the appropriate SHPO will be notified immediately. In Nevada, Native American human remains are protected under the provisions of the Protection of Indian Burial Sites section of the Nevada Revised Statutes (NRS) in Chapter 383. The

Nevada SHPO will consult with the Nevada Indian Commission and notify the appropriate Native American Tribe. Procedures for inadvertent discovery are listed under NRS 383.170. If the discovery of Native American human remains is made on State or private land in California, the California SHPO and the Native American Heritage Commission will be contacted. The Native American Heritage Commission will provide the name of a Most Likely Descendent who will then make recommendations for treatment and disposition of the remains and associated items.

Hazardous Materials and Waste (HM)

- HM 1. A Spill Prevention, Control, and Countermeasure Plan (SPCC) will be implemented during construction to prevent any spills. The SPCC, which will include cleanup procedures, will become part of the COM plan.

Recreation/Roads/Transportation (RT)

- RT 1. The use of any roads or trails will require compliance with the Carson Ranger District Motor Vehicle Use Map (MVUM), including any restrictions for seasonal use.
- RT 2. All new temporary access roads and all improvements to existing roads will comply with: 1) The Forest Service National Supplements to the FP-03 (USFS, 2010); 2) the USFS Road Construction Handbooks (FSH 7709.56 and FSH 7709.57); and, 3) the Forest Plan.
- RT 3. All new access roads (i.e., spur roads and centerline travel roads) specifically constructed for this project will be re-contoured and reclaimed and will have a physical closure installed to prevent motorized access immediately following the completion of construction and restoration. The types of closure and design specification used will be approved by the USFS prior to installation.
- RT 4. Physical barriers such as boulders or natural features designed to harmonize with the natural environment of the surrounding area will be installed to prevent unauthorized vehicle use from occurring on restored roads. The use of gates or other such structures for this purpose will be avoided unless determined necessary by the USFS.
- RT 5. Maintenance activities which cause a road to be opened to unauthorized vehicles or damage to restoration improvements will need to be assessed and barriers reinstalled as needed at the expense of NV Energy.
- RT 6. Restored roads will require a signage and monitoring plan implemented by NV Energy for compliance with the closure which will include inspecting the barricade areas to determine the effectiveness of the blockades at preventing unauthorized motorized vehicle use of the restored access roads. Signs will notify the public that construction access roads are closed and are being restored. Signs will be replaced by NV Energy if vandalism occurs to the signs.
- RT 7. If unauthorized vehicle use occurs on restored roads, barricades and reclamation will be monitored for effectiveness and remedial measures taken. Monitoring will continue until disturbed areas are successfully restored.
- RT 8. Public access will be maintained with minimal delays during the construction and maintenance of the project. If there are traffic delays, NV Energy will post delay information at National Forest portals.
- RT 9. All construction vehicle movement will be restricted to the transmission line ROW/easement, pre-designated access roads, public roads, and private roads. All existing roads will be left in a condition equal to or better than their preconstruction condition.

Visual Resources (VI)

- VI 1. Non-specular conductors will be installed to reduce visual impacts.
- VI 2. The number of new poles will be minimized by increasing the pole span length on NFS land where the area is designated as Partial Retention for Visual Quality Objectives as terrain allows.

Fire Prevention and Response (FP)

- FP 1. Fire Prevention Plan will be implemented during construction activities to prevent and suppress fire. The Fire Prevention Plan will be included in the COM Plan.

Air Quality (AQ)

- AQ 1. Vehicle and equipment speeds will be limited to 20 miles per hour on unpaved roads and on the ROW/easement.
- AQ 2. All areas subject to ground disturbance will be watered as needed to control dust.
- AQ 3. Paved roads will be swept if visible soil material is tracked onto them by construction vehicles.
- AQ 4. Excavation and grading activities will be suspended when winds (instantaneous gusts) exceed 50 miles per hour and visible dust persists that creates a health hazard to neighboring property owners and/or visibility impacts to vehicular traffic.
- AQ 5. In order to reduce construction equipment emissions, engines on construction-related vehicles will:
 - a) Be tuned to the engine manufacturer's specification in accordance with an appropriate time frame;
 - b) Not be idle for more than five minutes (unless it is necessary for the operating scope of the equipment and operation);
 - c) Not be tampered with in order to increase engine horsepower;
 - d) Include particulate traps, oxidation catalysts and other suitable control devices on all construction equipment used at the project site; and
 - e) Use diesel fuel having a sulfur content of 15 parts per million or less, or other suitable alternative diesel fuel, unless such fuel cannot be reasonably procured in the market area.

TAB D



**Neighborhood Meeting
Sign-In Sheet**

Project Name: _____

Meeting Location: _____

Meeting Date: _____

	First and Last Name (please print legibly)	Address	Email (or) Phone
1	Meeting conducted by Zoom - Please see uploaded registrant and participant list for further details		
2			
3			
4			
5			
6			
7			
8			

Disclaimer: A copy of this sign-in sheet will be submitted to Washoe County Planning Division along with the project application.

**Neighborhood Meeting
Comment Card**

Project Name: _____

Name: _____

Company/Organization (if applicable): _____

Address: _____

.....
Comment:

Meeting Conducted by Zoom - No comment cards in this format were received. Please see
chat text from Zoom and emailed questions, concerns and issues (provided with this file) as well
the audio recording of the meeting, all uploaded to the Washoe County Neighborhood Meeting
HUB for this project.

**Neighborhood Meeting
Comment Card**

Project Name: _____

Name: _____

Company/Organization (if applicable): _____

Address: _____

.....
Comment:

Project Name: _____
Meeting Location: _____
Meeting Date: _____

**Neighborhood Meeting
SUMMARY**

Virtual Meeting Option Provided: YES NO
Hosted By (Name): _____ (Company): _____
Contact (Email): _____ (Phone): _____

.....

Public Concerns:

1. _____
2. _____
3. _____
4. _____
5. _____

~~Changes Made to Proposal (if applicable):~~ Responses/Project Info to Public Concerns.

1. _____
2. _____
3. _____
4. _____
5. _____

Any Additional Comments:

Emailed questions from residents, prior to Neighborhood meeting

Following is a copy of the email text messages that have been received over the past 5 days, after the postcards were delivered to residents. A summary of the comment is provided before each copied message. We can discuss appropriate answers to these question tomorrow (Tuesday) when we meet.

Received 8/26

**Issues expressed - Addresses number of lines that will be in an existing corridor (I think)
Minimum clearance distance changes that may impact their property.**

Hello

I recently received a postcard regarding the NV Energy Line 1104 project and I have some questions. First would this project be adding 120kV to the current line or replacing the current line? Second, how would this line affect the minimal clearance distance for building? We own a parcel of land along these transmission lines and the line already greatly affects our allowable building area. If this new line affects it more, it will eliminate our ability to build our home. Please advise what might happen.

Thank you for any and all information you have.

Jessica Yurtinus

Received 8/25

**Issues Expressed - where does the line head north, near the West Meadows subdivision?
What will the addition of the 120 kV line look like?
Is the line needed specifically to serve a new project in the area?
Reason for O/H v. U/G?**

Hi Dave,

I have a few questions regarding the proposed NV Energy Line 1104.

I was just reviewing the parcel list from the provided mailer and cross referencing with the Washoe county mapping system and I'm not following the path of the line around the north end of West Meadows neighborhood. Specifically when does the line head north, and on what parcel?

Can you describe to me (or provide a photo) what an additional 120 V of power line will look like? Currently there are large lines on the north side of the West Meadows Community and I'm curious of the additional visual impact.

Is this power demand a result of the Stan Lucas' Mortensen Ranch development?

Finally, can you speak to the reason for the choice to use overhead powerlines vs underground. I suspect it has to do with cost, but I don't want to infer.

Thank you,

Ruth

Ruth Ebens | Patagonia Inc.

ruth.ebens@patagonia.com

Pronouns: she/her/hers

775.997.3451 | cell

Received 8/25

Issues expressed – High fire danger and why not go underground because of this. Issue with his Experiences with NV Energy maintenance in the past. Path close to Verdi ES. Visual impact and home values being reduced.

I live in the West Meadows subdivision in Verdi. I have some major concerns regarding the proposed project, "Line 1104". I would like to see this addressed at the upcoming Neighborhood Meeting on August 30, 2023.

1) Given the high fire danger in this area from long periods of heat and regular high winds, why are you not planning to take Line 1104 underground?

There are hundreds of homes in the hills around Verdi and hundreds more scheduled to be built. I have seen firsthand the devastation wind-powerline fires can cause; in Sonoma County California thousands of homes were lost because of this. These lines need to go underground.

2) NVE line powerline maintenance does not seem to be the best. I have reported unconnected stay-lines on wood power poles behind my house during high winds. They have never been fixed. On windy days these lines flap around like kites. (Picture of power pole attached.) These power poles are in line with the proposed project "Line 1104", per the information that I have seen. A) Will proposed Line 1104 replace this group of damaged wood power poles?, B) Will Line 1104 be an additional line?, C) What assurances does the neighborhood have that Line 1104 will be better care for than the current lines?

3) It seems that the proposed path of the overhead lines of 1104 is very close to Verdi Elementary school. Do high voltage lines, being close to a school (that will be growing) present a danger?

4) With the addition of Line 1104, the Verdi Valley close to the Truckee River will look like a spaghetti bowl of wires and poles. This will result in home values being reduced. My home has a view of the proposed project.

With addition of Line 1104, can other lines be removed, thus cleaning up the overall look of the area?

Thank you for the notice of this proposed project. Once again it greatly concerns me.

Thomas Silewicz

Received 8/24

Issues Expressed -

Wants copy of FEIS and ROD

Fire dangers

Escape route if fire breaks out.

Dear David

Thanks for your prompt response.

I would like more information such as a detailed map showing the construction roads as shown on page 13 of the attached document.

Also i would like to read the USFS final ROD and EIS documents.

The concern that I and other residents in West Reno-Somersett PUD and Verdi is all about wildfire danger. Since this project planning began in 2011 and was reviewed at a Washoe County Community Advisory Board in 2018, we have all learned more about transmission line failures during high wind causing terrible damage in areas such as Greenville California, Paradise California, and Carson City/Tahoe.

Did the ROD and EIS address wildfire dangers and the option to underground the transmission line?

You likely know that a large population increase in Verdi/West Reno/Somersett is underway through the recent District Court order involving the Mortensen Garson Overlay District [MGOD]. Recently the court ordered a 640 home project whose PUD will be intersected by the proposed transmission line. There are other developments underway in this area that has a high fire risk with only one southern evacuation route into I-80. You may know that about six high kV lines on poles cross I-80 at Mogul. If these lines should fail and close the road while current or the proposed Bordertown-Poeville line in our area cause a wildfire, our population will be stranded.

On Aug 23, 2023, at 5:42 PM, David Snelgrove <dsnelgrove@cfareno.com> wrote:

Warren:

Attached is the transmission line route map that we have uploaded to the Washoe County Neighborhood Meeting HUB site. It is not incredibly detailed but should give a general idea of location.

I hope this helps. Please feel free to reach out to me if you have any other questions.

Thank you.



A DBE/MBE/SBE Certified Company

David Snelgrove, A.I.C.P. | Planning Manager

CFA, Inc. | Direct: (775) 856-7073 | [Email: dsnelgrove@cfareno.com](mailto:dsnelgrove@cfareno.com)

1150 Corporate Blvd. | Reno, Nevada 89502



This email is confidential and intended solely for the use of the individual to whom it is addressed. If you are not the intended recipient, be advised that you have received this email in error and that any use, dissemination, forwarding, printing or copying of this email is strictly prohibited. If you have received this email in error please contact the sender. Any views or opinions presented are solely those of the author and do not necessarily represent those of CFA, Inc. Although this email and any attachments are believed to be free of any virus or other defects, no responsibility is accepted by CFA, Inc for any loss or damage arising in any way from the receipt or use thereof.

From: WARREN LYONS <warrenlyons@verizon.net>

Sent: Wednesday, August 23, 2023 5:35 PM

To: David Snelgrove <dsnelgrove@cfareno.com>

Cc: Warren Lyons <warrenlyons@verizon.net>

Subject: Nv energy line 1104

REceived the email notice. The links to a meeting do not provide a map showing the route for the line

Please send me a map showing the proposed line

Warren Lyons

warrenlyons@verizon.net

215-787-7922

9052 Cabin Creek Trail

Reno NV 89523

Received 8/24

**Issues expressed – Doesn't like powerline project due to limited mapping information
Wildfire concern.**

I strongly object to the line as currently plotted on the map provided. In part due to the lack of existing monuments/roadway markers and property lines. Secondly overhead lines have been the primary cause of wildfires. These lines should be buried underground and brought in the most direct way to Interstate 80. They should not transverse the community of Verdi which has burned a number of times in its history.

As proposed I think you put the community of over 2000 people at extreme risk.

--

Philip F Povey

Received 8/25 –

Issues Expressed - Will Additional poles and lines be added?

Mr. Snelgrove,

We received a Notice of Neighborhood Meeting to review the proposed 120kV overhead power transmission line proposed between Bordertown Substation and Verdi Substation. Does this include adding, or upgrading a line? Does it include installing new poles or using existing infrastructure? We are unable to access the website for project information so please advise what this entails.

We look forward to hearing from you.

Thank you,

Sally and Ken Oliver
370 River Pines Dr.
Verdi, NV 89439

Received 8/23 –
Issues Expressed -

Couldn't figure out the route or impact to his property.
I sent him the FEIS and ROD for a greater definition of the line location.
He wants to know what impact this will have on his property. Any graphics could help.

Dave,

Im not sure we've spoken since when I did The Eddy, but good to re-initiate conversations.

I am reaching out because got a notice in the mail that there will be a 120 KVA power line improvement project between the aforementioned locations, which is a deceiving description because in searching the APNs listed it will be going thru my backyard. The APNs are all over the place and dont make a ton of sense as presented, but it is clear that the power lines may be adding to/replacing the current lines running adjacent to my residence at 038-280-45.

I'm trying to keep my wife at bay, and as a developer avoid the immediate NIMBY response, so I was hoping you could send me some more detailed info prior to the Neighborhood meeting on 8/30/23. If we need to have a call to add context, please feel free to reach out.

Please and Thank You.



Kurt Stitser, LEED AP
Chief Operating Officer
(775) 737-3301

Zoom Chat Report

18:03:21 From Adrian Argyris To Everyone:

I have people contacting me saying they can not get into the meeting

18:03:57 From Warren Lyons To Everyone:

The cost benefit analysis of undergrounding the proposed transmission line as noted in the EIS and USFS Record of Decision, and in statements made to prior Washoe County community advisory boards, concluded that undergrounding is 7 to 10 times the cost of overheading.

This analysis is missing the issue of wild fire risk caused by transmission line failures. With over 8000 homes at c. \$500 per home equals 4 billion. We need to revisit the option to underground.

18:04:00 From Kurt Stitser To Everyone:

have them use the Meeting ID and Passcode rather than trying to type in the hyperlink

18:10:31 From Kurt Stitser To Everyone:

Once the proposed power line connects into existing transmission corridors near both Bordertown and Verdi, will the new line(s) be suspended from the same power pole structures, or will new power poles need to be installed/replaced?

18:15:08 From Casey Coffman To Everyone:

Will this project affect easement corridors in the Verdi Lake Estates neighborhood?

18:20:20 From Warren Lyons To Everyone:

Verdi-Somerset is in ward 5

18:20:46 From Kurt Gensheimer To Everyone:

Can you please provide a link to the USFS record of decision here in the chat? Thanks.

18:22:49 From Warren Lyons To Everyone:

Please address the option for under grounding to reduce risk

18:23:31 From Kenny Brown To Everyone:

<https://www.fs.usda.gov/project/?project=36656&exp=overview>

18:23:47 From D Kerr To Everyone:

What home development is near 15 & 16

18:30:38 From Kenny Brown To Dave Snelgrove(Privately):

Kelle George has her hand raised

18:35:37 From Casey Coffman To Everyone:

how do the dimensions of the new Verdi poles compare to the existing ones

18:39:18 From Casey Coffman To Everyone:

once again can you tell us about the height and width of the new poles

18:51:41 From Warren Lyons To Everyone:

Could we get a photo of #16 the triple turn tower

18:55:14 From Ruth Ebens To Everyone:

In this day and age, do we not think to the environment (fire potential) and future and run lines under ground?

18:55:45 From Adrian Argyris To Everyone:

Thank you -

Collated chat and zoom meeting questions

Kurt Stitser

Once the proposed power line connects into existing transmission corridors near both Bordertown and Verdi, will the new line(s) be suspended from the same power pole structures, or will new power poles need to be installed/replaced?

Voltage of new lines? Similar to existing?

Casey Coffman

Will this project affect easement corridors in the Verdi Lake Estates neighborhood? Reduce? Enlarge?

How do the dimensions of the new Verdi poles compare to the existing ones?

Once again can you tell us about the height and width of the new poles. Any sounds associated with lines?

Warren Lyons

Please address the option for under grounding to reduce risk

Could we get a photo of #16 the triple turn tower

D. Kerr

What home development is near 15 & 16

Are lines 17 - 20 near any home developments?

How close are lines 17-20 to the Stan Lucas project? Will it impact the Cliffs?

Adrian Argyrsis

Lives on Hill Lane. Line materials. Triple coated line?

Kellie George

Airplane lights, markers?

Different routes? How was route determined? Road alignments determined?

Sally Oliver

Will structures be removed?





How tall will structures be? How will affect views?































Jan Mooney

Pole on property line. Dark Brown, metal, tall.

Kendall Inskip

Access property through an ATV track. Widening of the dirt road. Timeframe for road widening in the back country and will they be able to use it.

 <p>Kenny Brown</p> <p><small>Dave Snelgrove</small></p>	 <p>Ken and Sally Ol...</p> <p><small>Jan Mooney</small></p>		
 <p>Warren Lyons</p> <p><small>Kendall Inskip</small></p>	 <p>Corey Tague</p> <p><small>Kellie George</small></p>		
<p>Laura Clifford</p> <p><small>Laura Clifford</small></p>	<p>Kurt Gensheimer</p> <p><small>Kurt Gensheimer</small></p>	<p>Casey Coffman</p> <p><small>Casey Coffman</small></p>	<p>D Kerr</p> <p><small>D Kerr</small></p>
<p>Ruth Ebens</p> <p><small>Ruth Ebens</small></p>			

- KB** Kenny Brown (Co-host, me)  
 - DS** Dave Snelgrove (Host)    
 - CT** Corey Tague  
 - KA** Ken and Sally Oliver  
 - CC** Casey Coffman  
 - DK** D Kerr  
 - JM** Jan Mooney  
 -  Kellie George  
 -  Kendall Inskip  
 - KG** Kurt Gensheimer  
 - LC** Laura Clifford  
 - RE** Ruth Ebens  
 - WL** Warren Lyons  
- [Ask to Unmute](#) 

User Name	User Email	Meeting ID	Topic	Host
Dave Snelgrove	dsnelly@charter.net	818 4835 4749	NV Energy Line 1104 - Neighborhood Meeting	Dave Snelgrove
Kenny Brown	kbrown@charter.net	818 4835 4749	NV Energy Line 1104 - Neighborhood Meeting	Dave Snelgrove
Warren Lyons	warrenlyons@verizon.net	818 4835 4749	NV Energy Line 1104 - Neighborhood Meeting	Dave Snelgrove
Corey Tague	corey.tague@nvenergy.com	818 4835 4749	NV Energy Line 1104 - Neighborhood Meeting	Dave Snelgrove
Laura Clifford	laura.clifford@nvenergy.com	818 4835 4749	NV Energy Line 1104 - Neighborhood Meeting	Dave Snelgrove
Adrian Argyris	dawgiewalks54@yahoo.com	818 4835 4749	NV Energy Line 1104 - Neighborhood Meeting	Dave Snelgrove
Casey Coffman	casey@trueroofingca.com	818 4835 4749	NV Energy Line 1104 - Neighborhood Meeting	Dave Snelgrove
Kurt Gensheimer	kurt@sierratrails.org	818 4835 4749	NV Energy Line 1104 - Neighborhood Meeting	Dave Snelgrove
Kendall Inskip	kinskip@washoeschools.net	818 4835 4749	NV Energy Line 1104 - Neighborhood Meeting	Dave Snelgrove
Kellie George	kellie@kelliergeorge.com	818 4835 4749	NV Energy Line 1104 - Neighborhood Meeting	Dave Snelgrove
Kurt Stitser	kstitser@realmconstructors.com	818 4835 4749	NV Energy Line 1104 - Neighborhood Meeting	Dave Snelgrove
Casey Coffman	casey@trueroofingca.com	818 4835 4749	NV Energy Line 1104 - Neighborhood Meeting	Dave Snelgrove
Jan Mooney	jmooney7308@att.net	818 4835 4749	NV Energy Line 1104 - Neighborhood Meeting	Dave Snelgrove
Adrian Argyris	dawgiewalks54@yahoo.com	818 4835 4749	NV Energy Line 1104 - Neighborhood Meeting	Dave Snelgrove
D Kerr	kerrd@jbc80.com	818 4835 4749	NV Energy Line 1104 - Neighborhood Meeting	Dave Snelgrove
Ken and Sally Oliver	kandsoliver@gmail.com	818 4835 4749	NV Energy Line 1104 - Neighborhood Meeting	Dave Snelgrove
Ruth Ebens	ruth.ebens@patagonia.com	818 4835 4749	NV Energy Line 1104 - Neighborhood Meeting	Dave Snelgrove

Host Account Name	Participants	Start Time	End Time	User Join Status	Join Time	Leave Time	Screen Share Used
Dave Snelgrove	1	8/30/2023 17:13	8/30/2023 19:03	In Meeting	8/30/2023 17:24	8/30/2023 17:25	No
Dave Snelgrove	1	8/30/2023 17:13	8/30/2023 19:03	In Meeting	8/30/2023 17:25	8/30/2023 19:03	No
Dave Snelgrove	1	8/30/2023 17:13	8/30/2023 19:03	In Meeting	8/30/2023 17:39	8/30/2023 19:03	No
Dave Snelgrove	1	8/30/2023 17:13	8/30/2023 19:03	In Meeting	8/30/2023 17:47	8/30/2023 19:03	No
Dave Snelgrove	1	8/30/2023 17:13	8/30/2023 19:03	In Meeting	8/30/2023 17:50	8/30/2023 19:03	No
Dave Snelgrove	1	8/30/2023 17:13	8/30/2023 19:03	In Meeting	8/30/2023 17:53	8/30/2023 18:55	No
Dave Snelgrove	1	8/30/2023 17:13	8/30/2023 19:03	In Meeting	8/30/2023 17:58	8/30/2023 17:59	No
Dave Snelgrove	1	8/30/2023 17:13	8/30/2023 19:03	In Meeting	8/30/2023 17:58	8/30/2023 19:03	No
Dave Snelgrove	1	8/30/2023 17:13	8/30/2023 19:03	In Meeting	8/30/2023 17:58	8/30/2023 19:03	No
Dave Snelgrove	1	8/30/2023 17:13	8/30/2023 19:03	In Meeting	8/30/2023 17:58	8/30/2023 19:03	No
Dave Snelgrove	1	8/30/2023 17:13	8/30/2023 19:03	In Meeting	8/30/2023 18:00	8/30/2023 18:43	No
Dave Snelgrove	1	8/30/2023 17:13	8/30/2023 19:03	In Meeting	8/30/2023 18:01	8/30/2023 19:03	No
Dave Snelgrove	1	8/30/2023 17:13	8/30/2023 19:03	In Meeting	8/30/2023 18:02	8/30/2023 19:03	No
Dave Snelgrove	1	8/30/2023 17:13	8/30/2023 19:03	In Meeting	8/30/2023 18:03	8/30/2023 18:57	No
Dave Snelgrove	1	8/30/2023 17:13	8/30/2023 19:03	In Meeting	8/30/2023 18:06	8/30/2023 19:03	No
Dave Snelgrove	1	8/30/2023 17:13	8/30/2023 19:03	In Meeting	8/30/2023 18:30	8/30/2023 19:03	No
Dave Snelgrove	1	8/30/2023 17:13	8/30/2023 19:03	In Meeting	8/30/2023 18:35	8/30/2023 19:03	No

File Transfer Used	Recording Used	Video Used	Phone Used	VOIP Used	Chat Used	Meeting Encryption Status	Internal
No	No	No	No	Yes	No	Enhanced en	Yes
No	No	No	No	Yes	Yes	Enhanced en	Yes
No	Yes	No	No	Yes	Yes	Enhanced en	Yes
No	No	No	Yes	No	Yes	Enhanced en	Yes
No	No	No	No	Yes	No	Enhanced en	Yes
No	No	No	No	Yes	Yes	Enhanced en	Yes
No	No	No	No	Yes	No	Enhanced en	Yes
No	No	No	No	Yes	Yes	Enhanced en	Yes
No	No	No	No	Yes	Yes	Enhanced en	Yes
No	No	No	No	Yes	No	Enhanced en	Yes
No	No	No	No	Yes	Yes	Enhanced en	Yes
No	No	No	No	Yes	Yes	Enhanced en	Yes
No	No	No	No	Yes	No	Enhanced en	Yes
No	No	No	No	Yes	Yes	Enhanced en	Yes
No	No	No	No	Yes	No	Enhanced en	Yes
No	No	No	No	Yes	Yes	Enhanced en	Yes

First Name	Last Name	Email	Registration Time	Approval Status
Ian	Meyer	imeyer@cfareno.com	8/21/2023 9:53	approved
Kenny	Brown	kbrown@cfareno.com	8/21/2023 9:54	approved
Carly	Borchard	ccborchard@gmail.com	8/24/2023 15:57	approved
Warren	Lyons	warrenlyons@verizon.net	8/24/2023 15:59	approved
Ruth	Ebens	ruth.ebens@patagonia.com	8/25/2023 12:31	approved
Adrian	Argyris	dawgiewalks54@yahoo.com	8/26/2023 8:50	approved
Jessica	Yurtinus	JYurtinus@unr.edu	8/26/2023 10:24	approved
Casey	Coffman	casey@trueroofingca.com	8/26/2023 10:27	approved
G	Pott	gpotnick@aol.com	8/29/2023 17:59	approved
Dave	Snelgrove	dsnelgrove@cfareno.com	8/30/2023 12:40	approved
Corey	Tague	corey.tague@nvenergy.com	8/30/2023 17:47	approved
Laura	Clifford	laura.clifford@nvenergy.com	8/30/2023 17:50	approved
Kurt	Gensheimer	kurt@sierratrails.org	8/30/2023 17:56	approved
Kurt	Stitser	kstitser@gmail.com	8/30/2023 17:57	approved
Kellie	George	Kellie@KellieRGeorge.com	8/30/2023 17:58	approved
Kendall Inskip		kinskip@washoeschools.net	8/30/2023 17:58	approved
Kurt Stitser		kstitser@realmconstructors.com	8/30/2023 17:59	approved
Jan	Mooney	jmooney7308@att.net	8/30/2023 18:02	approved
D	Kerr	Kerrd@jbc80.com	8/30/2023 18:06	approved
Ken and Sally	Oliver	kandsoliver@gmail.com	8/30/2023 18:29	approved

MH Layer

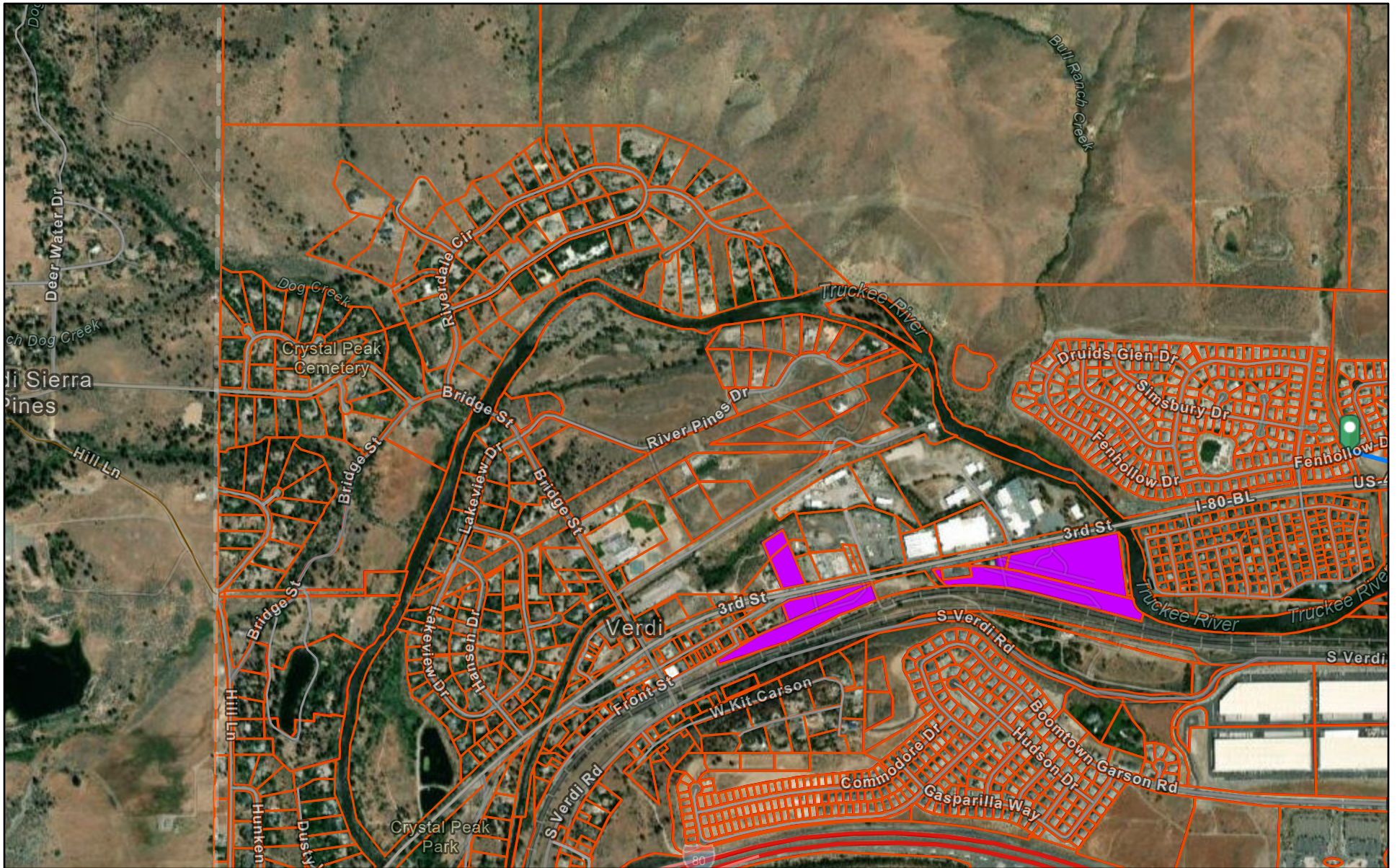

9/7/2023, 12:01:02 PM

- | | | |
|--------------|----------------|---------------------------|
| Roads | — LOCAL STREET | — DIRT ROAD |
| — INTERSTATE | — MAJOR ROAD | — Other |
| — RAMP | — CUL-DE-SAC | — Parcels - Washoe County |

- Parcels - City of Reno
- Mobile Home Communities

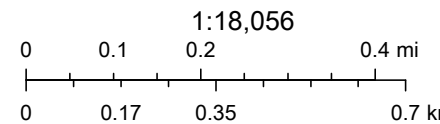

Esri Community Maps Contributors, California State Parks, Esri, HERE, Garmin, SafeGraph, GeoTechnologies, Inc, METI/NASA, USGS, Bureau of

NV Energy 1104 Line - Mobile Home Park Addresses

APN	Park Name	Property Owner	Unit Address(es)	City	State	Zip
038-060-20	MHM Mobile Home Park	H A N Z LLC	1100 Highway 40 W 5	Reno	NV	89439
	MHM Mobile Home Park	H A N Z LLC	1100 Highway 40 W 6	Reno	NV	89439
038-071-06	MHM Mobile Home Park	H A N Z LLC	1100 Highway 40 W	Reno	NV	89439
	MHM Mobile Home Park	H A N Z LLC	1100 Highway 40 W 1	Reno	NV	89439
	MHM Mobile Home Park	H A N Z LLC	1100 Highway 40 W 2	Reno	NV	89439
	MHM Mobile Home Park	H A N Z LLC	1100 Highway 40 W 3	Reno	NV	89439
	MHM Mobile Home Park	H A N Z LLC	1100 Highway 40 W 4	Reno	NV	89439
	MHM Mobile Home Park	H A N Z LLC	1100 Highway 40 W 5	Reno	NV	89439
	MHM Mobile Home Park	H A N Z LLC	1100 Highway 40 W 6	Reno	NV	89439
	MHM Mobile Home Park	H A N Z LLC	1100 Highway 40 W 7	Reno	NV	89439
	MHM Mobile Home Park	H A N Z LLC	1100 Highway 40 W 8	Reno	NV	89439
	MHM Mobile Home Park	H A N Z LLC	1100 Highway 40 W 9	Reno	NV	89439
	038-075-36	Crystal Trailer Park	Highfield, Glen R	1155 Highway 40 W	Reno	NV
Crystal Trailer Park		Highfield, Glen R	1155 Highway 40 W 2A	Reno	NV	89439
Crystal Trailer Park		Highfield, Glen R	1155 Highway 40 W 3A	Reno	NV	89439
Crystal Trailer Park		Highfield, Glen R	1155 Highway 40 W 4A	Reno	NV	89439
Crystal Trailer Park		Highfield, Glen R	1155 Highway 40 W 5A	Reno	NV	89439
Crystal Trailer Park		Highfield, Glen R	1155 Highway 40 W 6A	Reno	NV	89439
Crystal Trailer Park		Highfield, Glen R	1155 Highway 40 W 7A	Reno	NV	89439
Crystal Trailer Park		Highfield, Glen R	1155 Highway 40 W 8A	Reno	NV	89439
Crystal Trailer Park		Highfield, Glen R	1155 Highway 40 W A	Reno	NV	89439
Crystal Trailer Park		Highfield, Glen R	1155 Highway 40 W B	Reno	NV	89439
Crystal Trailer Park		Highfield, Glen R	1155 Highway 40 W C	Reno	NV	89439
038-075-37	Crystal Trailer Park	UNION PACIFIC RAILROAD COMPANY	1155 HIGHWAY 40 W 10B	Reno	NV	89439
	Crystal Trailer Park	UNION PACIFIC RAILROAD COMPANY	1155 HIGHWAY 40 W 11B	Reno	NV	89439
	Crystal Trailer Park	UNION PACIFIC RAILROAD COMPANY	1155 HIGHWAY 40 W 12B	Reno	NV	89439
	Crystal Trailer Park	UNION PACIFIC RAILROAD COMPANY	1155 HIGHWAY 40 W 13B	Reno	NV	89439
	Crystal Trailer Park	UNION PACIFIC RAILROAD COMPANY	1155 HIGHWAY 40 W 14B	Reno	NV	89439
	Crystal Trailer Park	UNION PACIFIC RAILROAD COMPANY	1155 HIGHWAY 40 W 15B	Reno	NV	89439
	Crystal Trailer Park	UNION PACIFIC RAILROAD COMPANY	1155 HIGHWAY 40 W 16B	Reno	NV	89439
	Crystal Trailer Park	UNION PACIFIC RAILROAD COMPANY	1155 HIGHWAY 40 W 17B	Reno	NV	89439
	Crystal Trailer Park	UNION PACIFIC RAILROAD COMPANY	1155 HIGHWAY 40 W 18B	Reno	NV	89439
	Crystal Trailer Park	UNION PACIFIC RAILROAD COMPANY	1155 HIGHWAY 40 W 19B	Reno	NV	89439
	Crystal Trailer Park	UNION PACIFIC RAILROAD COMPANY	1155 HIGHWAY 40 W 1BB	Reno	NV	89439

	Riverbelle Trailer Park	UNION PACIFIC RAILROAD COMPANY	1795 HIGHWAY 40 W 59	Reno	NV	89439
	Riverbelle Trailer Park	UNION PACIFIC RAILROAD COMPANY	1795 HIGHWAY 40 W 60	Reno	NV	89439
	Riverbelle Trailer Park	UNION PACIFIC RAILROAD COMPANY	1795 HIGHWAY 40 W 61	Reno	NV	89439
	Riverbelle Trailer Park	UNION PACIFIC RAILROAD COMPANY	1795 HIGHWAY 40 W 62	Reno	NV	89439
	Riverbelle Trailer Park	UNION PACIFIC RAILROAD COMPANY	1795 HIGHWAY 40 W 63	Reno	NV	89439
	Riverbelle Trailer Park	UNION PACIFIC RAILROAD COMPANY	1795 HIGHWAY 40 W 64	Reno	NV	89439
	Riverbelle Trailer Park	UNION PACIFIC RAILROAD COMPANY	1795 HIGHWAY 40 W 65	Reno	NV	89439
	Riverbelle Trailer Park	UNION PACIFIC RAILROAD COMPANY	1795 HIGHWAY 40 W 66	Reno	NV	89439
	Riverbelle Trailer Park	UNION PACIFIC RAILROAD COMPANY	1795 HIGHWAY 40 W 67	Reno	NV	89439
	Riverbelle Trailer Park	UNION PACIFIC RAILROAD COMPANY	1795 HIGHWAY 40 W 68	Reno	NV	89439
	Riverbelle Trailer Park	UNION PACIFIC RAILROAD COMPANY	1795 HIGHWAY 40 W 69	Reno	NV	89439
	Riverbelle Trailer Park	UNION PACIFIC RAILROAD COMPANY	1795 HIGHWAY 40 W 70	Reno	NV	89439
	Riverbelle Trailer Park	UNION PACIFIC RAILROAD COMPANY	1795 HIGHWAY 40 W 71	Reno	NV	89439
	Riverbelle Trailer Park	UNION PACIFIC RAILROAD COMPANY	1795 HIGHWAY 40 W 72	Reno	NV	89439
	Riverbelle Trailer Park	UNION PACIFIC RAILROAD COMPANY	1795 HIGHWAY 40 W 73	Reno	NV	89439
	Riverbelle Trailer Park	UNION PACIFIC RAILROAD COMPANY	1795 HIGHWAY 40 W 74	Reno	NV	89439